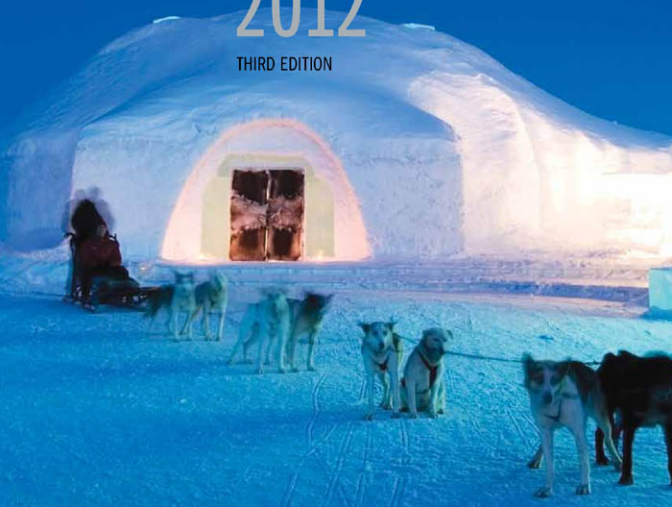


starting out with >>>

# VISUAL C#<sup>®</sup> 2012

THIRD EDITION



TONY GADDIS

STARTING OUT WITH

Visual C#<sup>®</sup>

2012

Third Edition

Tony Gaddis

Haywood Community College

PEARSON

Boston Columbus Indianapolis New York San Francisco Upper Saddle River  
Amsterdam Cape Town Dubai London Madrid Milan Munich Paris Montreal Toronto  
Delhi Mexico City São Paulo Sydney Hong Kong Seoul Singapore Taipei Tokyo

**Editorial Director, ECS:** Marcia Horton  
**Acquisitions Editor:** Matt Goldstein  
**Editorial Assistant:** Jenah Blitz-Stoehr  
**Director of Marketing:** Christy Lesko  
**Marketing Manager:** Yezan Alayan  
**Senior Marketing Coordinator:** Kathryn Ferranti  
**Director of Production:** Erin Gregg  
**Senior Managing Editor:** Scott Disanno  
**Production Project Manager:** Kayla Smith-Tarbox  
**Manufacturing Buyer:** Lisa McDowell  
**Art Director:** Anthony Gemellaro

**Cover Designer:** Joyce Wells  
**Manager, Rights and Permissions:** Michael Joyce  
**Text Permission Coordinator:** Jackie Bates, GEX  
**Cover Image:** Dimitar Todorov/Alamy  
**Media Project Manager:** Renata Butera  
**Full-Service Project Management:**  
Mohinder Singh/Aptara®, Inc.  
**Composition:** Aptara®, Inc.  
**Printer/Binder:** Edwards Brothers  
**Cover Printer:** Edwards Brothers  
**Text Font:** Sabon LT Std

Credits and acknowledgments borrowed from other sources and reproduced, with permission, in this textbook appear on the appropriate page within text.

**Credit:** Figure B.11: WebBrowser Demo application <http://www.pearsonhighered.com/gaddisbooks>

Copyright © 2012 by Microsoft Corporation. Used with permission from Microsoft. Microsoft and/or its respective suppliers make no representations about the suitability of the information contained in the documents and related graphics published as part of the services for any purpose. All such documents and related graphics are provided “as is” without warranty of any kind. Microsoft and/or its respective suppliers hereby disclaim all warranties and conditions with regard to this information, including all warranties and conditions of merchantability, whether express, implied or statutory, fitness for a particular purpose, title and non-infringement. In no event shall Microsoft and/or its respective suppliers be liable for any special, indirect or consequential damages or any damages whatsoever resulting from loss of use, data or profits, whether in an action of contract, negligence or other tortious action, arising out of or in connection with the use or performance of information available from the services. The documents and related graphics contained herein could include technical inaccuracies or typographical errors. Changes are periodically added to the information herein. Microsoft and/or its respective suppliers may make improvements and/or changes in the product(s) and/or the program(s) described herein at any time. Partial screen shots may be viewed in full within the software version specified.

---

Copyright © 2014, 2011, 2008 Pearson Education, Inc., publishing as Addison-Wesley. All rights reserved. Printed in the United States of America. This publication is protected by Copyright, and permission should be obtained from the publisher prior to any prohibited reproduction, storage in a retrieval system, or transmission in any form or by any means, electronic, mechanical, photocopying, recording, or likewise. To obtain permission(s) to use material from this work, please submit a written request to Pearson Education, Inc., Permissions Department, One Lake Street, Upper Saddle River, New Jersey 07458, or you may fax your request to 201-236-3290.

Many of the designations by manufacturers and sellers to distinguish their products are claimed as trademarks. Where those designations appear in this book, and the publisher was aware of a trademark claim, the designations have been printed in initial caps or all caps.

The programs and applications presented in this book have been included for their instructional value. They have been tested with care, but are not guaranteed for any particular purpose. The publisher does not offer any warranties or representations, nor does it accept any liabilities with respect to the programs or applications.

#### Library of Congress Cataloging-in-Publication Data

Gaddis, Tony.

Starting out with Visual C# 2012 / Tony Gaddis, Haywood Community College.—Third edition.

pages cm

Includes index.

ISBN-13: 978-0-13-312945-8

ISBN-10: 0-13-312945-4

1. C# (Computer program language) 2. Visual programming languages (Computer science) I. Title.

QA76.73.C154G33 2014

005.13'3—dc23

2012051581

Proudly sourced and uploaded by [StormRG]

Kickass Torrents | TPB | ET | h33t

10 9 8 7 6 5 4 3 2 1

**PEARSON**

ISBN 13: 978-0-13-312945-8

ISBN 10: 0-13-312945-4

# Locations of VideoNotes

[www.pearsonhighered.com/gaddis](http://www.pearsonhighered.com/gaddis)



VideoNote

<b>Chapter 1</b>	Tutorial 1-1: Starting Visual Studio and Setting Up the Environment . . . . .	28
	Tutorial 1-2: Starting a New Visual C# Project. . . . .	31
	Tutorial 1-3: Saving and Closing a Project. . . . .	33
	Tutorial 1-4: Opening an Existing Project . . . . .	41
	Tutorial 1-5: Getting Familiar with the Visual Studio Environment . . . . .	43
<b>Chapter 2</b>	Tutorial 2-1: Creating the GUI for the <i>Hello World</i> Application. .	63
	Tutorial 2-2: Writing Code for the <i>Hello World</i> Application . . . .	77
	Tutorial 2-3: Creating the <i>Language Translator</i> Application . . . .	88
	Tutorial 2-4: Creating the <i>Flags</i> Application . . . . .	96
	Tutorial 2-5: Creating the <i>Card Flip</i> Application. . . . .	100
	Solving the Clickable Number Images Problem . . . . .	115
<b>Chapter 3</b>	Tutorial 3-1: The <i>Birth Date String</i> Application. . . . .	128
	Tutorial 3-2: Calculating Fuel Economy . . . . .	148
	Tutorial 3-3: Creating the <i>Sale Price Calculator</i> Application with Currency Formatting . . . . .	154
	Tutorial 3-4: Creating the <i>Test Average</i> Application with Exception Handling . . . . .	162
	Tutorial 3-5: Creating the <i>Change Counter</i> Application . . . . .	171
	Solving the Tip, Tax, and Total Problem . . . . .	192
<b>Chapter 4</b>	Tutorial 4-1: Completing the <i>Test Score Average</i> Application . .	202
	Tutorial 4-2: Completing the <i>Payroll with Overtime</i> Application. .	208
	Tutorial 4-3: Completing the <i>Loan Qualifier</i> Application . . . . .	214
	Tutorial 4-4: Calculating Fuel Economy . . . . .	237
	Tutorial 4-5: Creating the <i>Color Theme</i> Application . . . . .	246
	Tutorial 4-6: Creating the <i>Time Zone</i> Application . . . . .	253
	Solving the Mass and Weight Problem . . . . .	262
<b>Chapter 5</b>	Tutorial 5-1: Using a Loop to Calculate an Account Balance . .	273
	Tutorial 5-2: Enhancing the <i>Ending Balance</i> Application . . . . .	276
	Tutorial 5-3: Using the <code>for</code> Loop . . . . .	286
	Tutorial 5-4: Writing Data to a Text File . . . . .	297
	Tutorial 5-5: Appending Data to the <i>Friend.txt</i> File. . . . .	302
	Tutorial 5-6: Using a Loop to Read to the End of a File . . . . .	310
	Tutorial 5-7: Calculating a Running Total . . . . .	314
	Tutorial 5-8: Simulating Coin Tosses. . . . .	325
	Tutorial 5-9: Creating a Load Event Handler . . . . .	329
	Solving the Celsius-to-Fahrenheit Table Problem . . . . .	336
<b>Chapter 6</b>	Tutorial 6-1: Creating and Calling Methods . . . . .	345
	Tutorial 6-2: Passing an Argument to a Method . . . . .	352

	Tutorial 6-3: Using an Output Parameter . . . . .	363
	Tutorial 6-4: Writing a Value-Returning Method . . . . .	372
	Tutorial 6-5: Modularizing Input Validation with a Boolean Method. . . . .	375
	Solving the Kinetic Energy Problem . . . . .	384
<b>Chapter 7</b>	Tutorial 7-1: Using an Array to Hold a List of Random Lottery Numbers . . . . .	399
	Tutorial 7-2: Processing an Array . . . . .	424
	Tutorial 7-3: Completing the <i>Seating Chart</i> Application . . . . .	439
	Tutorial 7-4: Completing the <i>Test Score List</i> Application . . . . .	452
	Solving the Total Sales Problem . . . . .	461
<b>Chapter 8</b>	Tutorial 8-1: Completing the <i>Password Validation</i> Application .	471
	Tutorial 8-2: Completing the <i>Telephone Format</i> Application . .	484
	Tutorial 8-3: Completing the <i>Telephone Unformat</i> Application	488
	Tutorial 8-4: Completing the <i>CSV Reader</i> Application . . . . .	494
	Tutorial 8-5: Completing the <i>Phonebook</i> Application . . . . .	509
	Tutorial 8-6: Completing the <i>Color Spectrum</i> Application . . . .	517
	Tutorial 8-7: Completing the <i>Random Card</i> Application . . . . .	524
	Solving the Sum of Numbers in a String Problem . . . . .	531
<b>Chapter 9</b>	Tutorial 9-1: Creating and Using the <code>coin</code> Class . . . . .	542
	Tutorial 9-2: Creating and Using the <code>cellPhone</code> Class . . . . .	550
	Tutorial 9-3: Creating and Using the <code>BankAccount</code> Class . . . . .	556
	Tutorial 9-4: Completing the <i>Cell Phone Inventory</i> Application	564
	Tutorial 9-5: Creating an Application with Two Forms . . . . .	581
	Solving the Pet Class Problem. . . . .	590
<b>Chapter 10</b>	Tutorial 10-1: Creating and Testing the <code>savingsAccount</code> and <code>CDAccount</code> Classes . . . . .	603
	Tutorial 10-2: Completing the <i>Polymorphism</i> Application . . . .	616
	Tutorial 10-3: Completing the <i>Computer Science Student</i> Application. . . . .	623
	Solving the <code>Employee</code> and <code>ProductionWorker</code> Classes Problem . . . . .	631
<b>Chapter 11</b>	Tutorial 11-1: Starting the <i>Phone Book</i> Application and Creating the <code>Phonelist.mdf</code> Database . . . . .	639
	Tutorial 11-2: Completing the <i>Phone Book</i> Application . . . . .	648
	Tutorial 11-3: Creating the <i>Products</i> Application and Using a Details View. . . . .	657
	Tutorial 11-4: Creating the <i>Product Lookup</i> Application. . . . .	669
	Tutorial 11-5: Creating the <i>Multiform Products</i> Application . . .	672
	Tutorial 11-6: Creating the <i>Product Queries</i> Application. . . . .	684
	Tutorial 11-7: Creating the <i>Product Queries</i> Application. . . . .	693
	Tutorial 11-8: Creating the <i>Product Search</i> Application . . . . .	697
	Solving the Personnel Database Problem . . . . .	707

# Brief Contents

Chapter 1	<b>Introduction to Computers and Programming</b>	<b>1</b>
Chapter 2	<b>Introduction to Visual C#</b>	<b>53</b>
Chapter 3	<b>Processing Data</b>	<b>119</b>
Chapter 4	<b>Making Decisions</b>	<b>197</b>
Chapter 5	<b>Loops, Files, and Random Numbers</b>	<b>267</b>
Chapter 6	<b>Modularizing Your Code with Methods</b>	<b>339</b>
Chapter 7	<b>Arrays and Lists</b>	<b>389</b>
Chapter 8	<b>More about Processing Data</b>	<b>465</b>
Chapter 9	<b>Classes and Multiform Projects</b>	<b>535</b>
Chapter 10	<b>Inheritance and Polymorphism</b>	<b>593</b>
Chapter 11	<b>Databases</b>	<b>633</b>
Appendix A	<b>C# Primitive Data Types</b>	<b>709</b>
Appendix B	<b>Additional User Interface Controls</b>	<b>711</b>
Appendix C	<b>ASCII/Unicode Characters</b>	<b>731</b>
Appendix D	<b>Answers to Checkpoint Questions</b>	<b>733</b>

# Contents

## Preface xi

## Attention Students xvi

### Chapter 1 Introduction to Computers and Programming 1

1.1	Introduction.....	1
1.2	Hardware and Software.....	2
1.3	How Computers Store Data.....	7
1.4	How a Program Works .....	11
1.5	Graphical User Interfaces.....	18
1.6	Objects .....	21
1.7	The Program Development Process.....	23
1.8	Getting Started with the Visual Studio Environment.....	27
	<b>TUTORIAL 1-1: Starting Visual Studio and Setting Up the Environment.....</b>	<b>28</b>
	<b>TUTORIAL 1-2: Starting a New Visual C# Project.....</b>	<b>31</b>
	<b>TUTORIAL 1-3: Saving and Closing a Project.....</b>	<b>33</b>
	<b>TUTORIAL 1-4: Opening an Existing Project.....</b>	<b>41</b>
	<b>TUTORIAL 1-5: Getting Familiar with the Visual Studio Environment.....</b>	<b>43</b>
	<i>Key Terms</i> 44 • <i>Review Questions</i> 45 • <i>Programming Problems</i> 50	

### Chapter 2 Introduction to Visual C# 53

2.1	Getting Started with Forms and Controls.....	53
2.2	Creating the GUI for Your First Visual C# Application: The <i>Hello World</i> Application.....	62
	<b>TUTORIAL 2-1: Creating the GUI for the <i>Hello World</i> Application.....</b>	<b>63</b>
2.3	Introduction to C# Code.....	67
2.4	Writing Code for the <i>Hello World</i> Application.....	77
	<b>TUTORIAL 2-2: Writing Code for the <i>Hello World</i> Application.....</b>	<b>77</b>
2.5	Label Controls.....	80
	<b>TUTORIAL 2-3: Creating the <i>Language Translator</i> Application.....</b>	<b>88</b>
2.6	Making Sense of IntelliSense.....	91
2.7	PictureBox Controls.....	92
	<b>TUTORIAL 2-4: Creating the <i>Flags</i> Application.....</b>	<b>96</b>
	<b>TUTORIAL 2-5: Creating the <i>Card Flip</i> Application.....</b>	<b>100</b>
2.8	Comments, Blank Lines, and Indentation.....	104
2.9	Writing the Code to Close an Application's Form.....	106
2.10	Dealing with Syntax Errors.....	107
	<i>Key Terms</i> 109 • <i>Review Questions</i> 109 • <i>Programming Problems</i> 114	

**Chapter 3 Processing Data 119**

- 3.1 Reading Input with TextBox Controls . . . . . 119
- 3.2 A First Look at Variables. . . . . 121
- TUTORIAL 3-1: The Birth Date String Application . . . . . 128**
- 3.3 Numeric Data Types and Variables . . . . . 133
- 3.4 Performing Calculations . . . . . 138
- 3.5 Inputting and Outputting Numeric Values . . . . . 143
- TUTORIAL 3-2: Calculating Fuel Economy . . . . . 148**
- 3.6 Formatting Numbers with the ToString Method . . . . . 151
- TUTORIAL 3-3: Creating the Sale Price Calculator Application with Currency Formatting . . . . . 154**
- 3.7 Simple Exception Handling . . . . . 158
- TUTORIAL 3-4: Creating the Test Average Application with Exception Handling . . 162**
- 3.8 Using Named Constants . . . . . 166
- 3.9 Declaring Variables as Fields . . . . . 167
- TUTORIAL 3-5: Creating the Change Counter Application . . . . . 171**
- 3.10 Using the Math Class. . . . . 175
- 3.11 More GUI Details. . . . . 177

*Key Terms 187 • Review Questions 187 • Programming Problems 192*

**Chapter 4 Making Decisions 197**

- 4.1 Decision Structures and the if Statement. . . . . 197
- TUTORIAL 4-1: Completing the Test Score Average Application. . . . . 202**
- 4.2 The if-else Statement . . . . . 206
- TUTORIAL 4-2: Completing the Payroll with Overtime Application . . . . . 208**
- 4.3 Nested Decision Structures . . . . . 212
- TUTORIAL 4-3: Completing the Loan Qualifier Application . . . . . 214**
- 4.4 Logical Operators . . . . . 223
- 4.5 bool Variables and Flags . . . . . 228
- 4.6 Comparing Strings . . . . . 228
- 4.7 Preventing Data Conversion Exceptions with the TryParse Methods . . . 232
- TUTORIAL 4-4: Calculating Fuel Economy . . . . . 237**
- 4.8 Input Validation . . . . . 240
- 4.9 Radio Buttons and Check Boxes . . . . . 241
- TUTORIAL 4-5: Creating the Color Theme Application. . . . . 246**
- 4.10 The switch Statement . . . . . 248
- 4.11 Introduction to List Boxes . . . . . 251
- TUTORIAL 4-6: Creating the Time Zone Application . . . . . 253**

*Key Terms 257 • Review Questions 257 • Programming Problems 261*

**Chapter 5 Loops, Files, and Random Numbers 267**

- 5.1 More about ListBoxes . . . . . 267
- 5.2 The while Loop . . . . . 269
- TUTORIAL 5-1: Using a Loop to Calculate an Account Balance . . . . . 273**
- TUTORIAL 5-2: Enhancing the Ending Balance Application . . . . . 276**



5.3	The ++ and -- operators . . . . .	280
5.4	The for Loop . . . . .	281
	<b>TUTORIAL 5-3: Using the for Loop</b> . . . . .	286
5.5	The do-while Loop . . . . .	289
5.6	Using Files for Data Storage. . . . .	291
	<b>TUTORIAL 5-4: Writing Data to a Text File</b> . . . . .	297
	<b>TUTORIAL 5-5: Appending Data to the Friend.txt File</b> . . . . .	302
	<b>TUTORIAL 5-6: Using a Loop to Read to the End of a File</b> . . . . .	310
	<b>TUTORIAL 5-7: Calculating a Running Total</b> . . . . .	314
5.7	The OpenFileDialog and SaveFileDialog Controls . . . . .	317
5.8	Random Numbers. . . . .	323
	<b>TUTORIAL 5-8: Simulating Coin Tosses</b> . . . . .	325
5.9	The Load Event. . . . .	328
	<b>TUTORIAL 5-9: Creating a Load Event Handler</b> . . . . .	329
	<i>Key Terms</i> 332 • <i>Review Questions</i> 332 • <i>Programming Problems</i> 335	

## Chapter 6 **Modularizing Your Code with Methods** 339

6.1	Introduction to Methods. . . . .	339
6.2	void Methods. . . . .	341
	<b>TUTORIAL 6-1: Creating and Calling Methods</b> . . . . .	345
6.3	Passing Arguments to Methods. . . . .	349
	<b>TUTORIAL 6-2: Passing an Argument to a Method</b> . . . . .	352
6.4	Passing Arguments by Reference. . . . .	360
	<b>TUTORIAL 6-3: Using an Output Parameter</b> . . . . .	363
6.5	Value-Returning Methods . . . . .	367
	<b>TUTORIAL 6-4: Writing a Value-Returning Method</b> . . . . .	372
	<b>TUTORIAL 6-5: Modularizing Input Validation with a Boolean Method.</b> . . . . .	375
	<i>Key Terms</i> 381 • <i>Review Questions</i> 381 • <i>Programming Problems</i> 384	

## Chapter 7 **Arrays and Lists** 389

7.1	Value Types and Reference Types . . . . .	389
7.2	Array Basics. . . . .	392
	<b>TUTORIAL 7-1: Using an Array to Hold a List of Random Lottery Numbers</b> . . . . .	399
7.3	Working with Files and Arrays . . . . .	404
7.4	Passing Arrays as Arguments to Methods. . . . .	407
7.5	Some Useful Array Algorithms . . . . .	414
	<b>TUTORIAL 7-2: Processing an Array</b> . . . . .	424
7.6	Advanced Algorithms for Sorting and Searching Arrays. . . . .	429
7.7	Two-Dimensional Arrays . . . . .	436
	<b>TUTORIAL 7-3: Completing the Seating Chart Application</b> . . . . .	439
7.8	Jagged Arrays . . . . .	445
7.9	The List Collection . . . . .	446
	<b>TUTORIAL 7-4: Completing the Test Score List Application</b> . . . . .	452
	<i>Key Terms</i> 458 • <i>Review Questions</i> 458 • <i>Programming Problems</i> 461	

Chapter 8	<b>More about Processing Data</b>	<b>465</b>
8.1	Introduction	465
8.2	String and Character Processing	465
	<b>TUTORIAL 8-1:</b> Completing the <i>Password Validation</i> Application	471
	<b>TUTORIAL 8-2:</b> Completing the <i>Telephone Format</i> Application	484
	<b>TUTORIAL 8-3:</b> Completing the <i>Telephone Unformat</i> Application	488
	<b>TUTORIAL 8-4:</b> Completing the <i>CSV Reader</i> Application	494
8.3	Structures	499
	<b>TUTORIAL 8-5:</b> Completing the <i>Phonebook</i> Application	509
8.4	Enumerated Types	514
	<b>TUTORIAL 8-6:</b> Completing the <i>Color Spectrum</i> Application	517
8.5	The ImageList Control	522
	<b>TUTORIAL 8-7:</b> Completing the <i>Random Card</i> Application	524
	<i>Key Terms</i> 527 • <i>Review Questions</i> 527 • <i>Programming Problems</i> 531	
Chapter 9	<b>Classes and Multiform Projects</b>	<b>535</b>
9.1	Introduction to Classes	535
	<b>TUTORIAL 9-1:</b> Creating and Using the <i>Coin</i> Class	542
9.2	Properties	547
	<b>TUTORIAL 9-2:</b> Creating and Using the <i>CellPhone</i> Class	550
9.3	Parameterized Constructors and Overloading	555
	<b>TUTORIAL 9-3:</b> Creating and Using the <i>BankAccount</i> Class	556
9.4	Storing Class Type Objects in Arrays and Lists	562
	<b>TUTORIAL 9-4:</b> Completing the <i>Cell Phone Inventory</i> Application	564
9.5	Finding the Classes and Their Responsibilities in a Problem	568
9.6	Creating Multiple Forms in a Project	576
	<b>TUTORIAL 9-5:</b> Creating an Application with Two Forms	581
	<i>Key Terms</i> 586 • <i>Review Questions</i> 586 • <i>Programming Problems</i> 590	
Chapter 10	<b>Inheritance and Polymorphism</b>	<b>593</b>
10.1	Inheritance	593
	<b>TUTORIAL 10-1:</b> Creating and Testing the <i>SavingsAccount</i> and <i>CDAccount</i> Classes	603
10.2	Polymorphism	611
	<b>TUTORIAL 10-2:</b> Completing the <i>Polymorphism</i> Application	616
10.3	Abstract Classes	621
	<b>TUTORIAL 10-3:</b> Completing the <i>Computer Science Student</i> Application	623
	<i>Key Terms</i> 628 • <i>Review Questions</i> 628 • <i>Programming Problems</i> 631	
Chapter 11	<b>Databases</b>	<b>633</b>
11.1	Introduction to Database Management Systems	633
11.2	Tables, Rows, and Columns	635
11.3	Creating a Database in Visual Studio	638

**TUTORIAL 11-1:** Starting the *Phone Book* Application and Creating the  
    *Phonelist.mdf* Database . . . . . 639

11.4 The DataGridView Control . . . . . 648

**TUTORIAL 11-2:** Completing the *Phone Book* Application . . . . . 648

11.5 Connecting to an Existing Database and Using Details View Controls . . . . 656

**TUTORIAL 11-3:** Creating the *Products* Application and Using a Details View . . . . 657

11.6 More about Data-Bound Controls . . . . . 665

**TUTORIAL 11-4:** Creating the *Product Lookup* Application . . . . . 669

**TUTORIAL 11-5:** Creating the *Multiform Products* Application . . . . . 672

11.7 Selecting Data with the SQL `select` Statement. . . . . 677

**TUTORIAL 11-6:** Creating the *Product Queries* Application . . . . . 684

**TUTORIAL 11-7:** Creating the *Product Queries* Application . . . . . 693

**TUTORIAL 11-8:** Creating the *Product Search* Application . . . . . 697

*Key Terms* 703 • *Review Questions* 703 • *Programming Problems* 707

Appendix A **C# Primitive Data Types** . . . . . **709**

Appendix B **Additional User Interface Controls** . . . . . **711**

Appendix C **ASCII/Unicode Characters** . . . . . **731**

Appendix D **Answers to Checkpoint Questions** . . . . . **733**

**Index** . . . . . **753**

# Preface

**W**elcome to *Starting Out with Visual C# 2012*, Third Edition. This book is intended for an introductory programming course and is ideal for students with no prior experience. Students who are new to programming will appreciate the clear, down-to-earth explanations and the detailed walk-throughs that are provided by the hands-on tutorials. More experienced students will appreciate the depth of detail as they learn about the .NET Framework, databases, and other topics.

As with all the books in the *Starting Out With* series, the hallmark of this text is its clear, friendly, and easy-to-understand writing. In addition, it is rich in example programs that are concise and practical. The programs in this book include short examples that highlight specific programming topics, as well as more involved examples that focus on problem solving. Each chapter provides numerous hands-on tutorials that guide the student through each step of the development of an application. In addition to detailed, step-by-step instructions, the tutorials also provide the application's completed code and screen captures of the completed forms.

## **New to This Edition**

This edition has been revised to be compatible with Visual C# 2012 and the Visual Studio 2012 environment. In addition, a full set of VideoNotes has been developed to accompany each tutorial in the book. Students can follow along with the author as he works through each tutorial in the videos. Also, one programming exercise at the end of each chapter has an accompanying VideoNote that shows the student how to create the solution. The VideoNotes are available on the book's companion Web site, at [www.pearsonhighered.com/gaddis](http://www.pearsonhighered.com/gaddis).

## **A GUI-Based Approach**

Beginning students are more motivated to learn programming when their applications have some sort of graphical element, such as a graphical user interface. Students using this book will learn to create GUI-based, event-driven, Visual C# applications. The Visual Studio (or Visual Studio Express for Windows Desktop) environment is used to create forms that are rich with user interface controls and graphical images.

## **Learn to Use Objects Early, Learn to Write Classes Later**

This book explains what objects are very early and shows the student how to create objects from classes that are provided by the .NET Framework. It then introduces the student to the fundamentals of input and output, control structures, methods, arrays and lists, and file I/O. Then the student learns to write his or her own classes and explores the topics of inheritance and polymorphism.

## **Visual Studio and Visual Studio Express for Windows Desktop**

The book can be used with either Visual Studio 2012 or Visual Studio 2012 Express for Windows Desktop. The book is bundled with Microsoft's Visual Studio 2012 Express for Windows Desktop—a streamlined product that captures the best elements of

Visual Studio in an ideal format for learning programming. The Express Edition offers an impressive set of tools for developing and debugging applications, including those that work with databases and use SQL.

## Brief Overview of Each Chapter

**Chapter 1: Introduction to Computers and Programming.** This chapter begins by giving a very concrete and easy-to-understand explanation of how computers work, how data is stored and manipulated, and why we write programs in high-level languages. In this chapter, the student learns what an object is and sees several examples by studying the objects that make up a program's graphical user interface. The chapter discusses steps in the programming development cycle. It also gives an introduction to the Visual Studio or Visual Studio Express environment.

**Chapter 2: Introduction to Visual C#.** In this chapter the student learns to create forms with labels, buttons, and picture boxes and learns to modify control properties. The student is introduced to C# code and learns the organizational structure of namespaces, classes, and methods. The student learns to write simple event-driven applications that respond to button clicks or provide interaction through clickable images. The importance of commenting code is also discussed.

**Chapter 3: Processing Data.** This chapter introduces variables and data types. It discusses the use of local variables and variables declared as fields within a form class. The student learns to create applications that read input from TextBox controls, perform mathematical operations, and produce formatted output. The student learns about the exceptions that can occur when the user enters invalid data into a TextBox and learns to write simple exception-handling code to deal with those problems. Named constants are introduced as a way of representing unchanging values and creating self-documenting, maintainable code. The student also learns more intricacies of creating graphical user interfaces.

**Chapter 4: Making Decisions.** In this chapter the student learns about relational operators and Boolean expressions and is shown how to control the flow of a program with decision structures. The `if`, `if-else`, and `if-else-if` statements are covered. Nested decision structures, logical operators, and the `switch` statement are also discussed. The student learns to use the `TryParse` family of methods to validate input and prevent exceptions. Radio buttons, check boxes, and list boxes are introduced as ways to let the user select items in a GUI.

**Chapter 5: Loops, Files, and Random Numbers.** This chapter shows the student how to use loops to create repetition structures. The `while` loop, the `for` loop, and the `do-while` loop are presented. Counters, accumulators, and running totals are also discussed. This chapter also introduces sequential file input and output and using text files. The student learns various programming techniques for writing data to text files and reading the contents of text files. The chapter concludes with a discussion of pseudorandom numbers, their applications, and how to generate them.

**Chapter 6: Modularizing Your Code with Methods.** In this chapter the student first learns how to write and call `void` methods. The chapter shows the benefits of using methods to modularize programs and discusses the top-down design approach. Then, the student learns to pass arguments to methods. Passing by value, by reference, and output parameters are discussed. Finally, the student learns to write value-returning methods.

**Chapter 7: Arrays and Lists.** Arrays and lists are reference-type objects in C#, so this chapter begins by discussing the difference between value type and reference type objects in the C# language. Then, the student learns to create and work with single-dimensional and two-dimensional arrays. The student learns to pass arrays as arguments to methods,

transfer data between arrays and files, work with partially filled arrays, and create jagged arrays. Many examples of array processing are provided including examples of finding the sum, average, highest, and lowest values in an array. Finally, the student learns to create `List` objects and store data in them.

**Chapter 8: More about Processing Data.** This chapter presents several diverse topics. Now that the student has studied the fundamentals of Visual C# programming, he or she can use the topics presented in this chapter to perform more advanced operations. First, various string and character processing techniques are introduced. Then the student learns to use structures to encapsulate several variables into a single item. The student next learns to create and use enumerated types. Last, the student learns about the `ImageList` control, a data structure for storing and retrieving images.

**Chapter 9: Classes and Multiform Projects.** Up to this point, the student has extensively used objects that are instances of .NET Framework classes. In this chapter the student learns to write classes to create his or her own objects. The student learns to create fields, methods, and constructors and learns to implement properties. Creating arrays of objects and storing objects in a `List` are also discussed. A primer on finding the classes in a problem as well as their responsibilities is provided. Finally, the chapter shows the student how to create multiple form classes in a project, instantiate those classes, and display them.

**Chapter 10: Inheritance and Polymorphism.** The study of classes continues in this chapter with the subjects of inheritance and polymorphism. The topics covered include base classes, derived classes, how constructors functions work in inheritance, method overriding, and polymorphism. Abstract classes and abstract methods are also discussed.

**Chapter 11: Databases.** This chapter introduces the student to basic database concepts. The student first learns about tables, rows, and columns and how to create an SQL Server database in Visual Studio. The student then learns how to connect a database to a Visual C# application and display a table in a `DataGridView` control, a `Details` view, and other data-bound controls. Finally, the student learns how to write SQL `Select` statements to retrieve data from a table.

**Appendix A: C# Primitive Data Types.** This appendix gives an overview of the primitive data types available in C#.

**Appendix B: Additional User Interface Controls.** This appendix shows how to create a variety of controls such as `ToolTips`, combo boxes, scroll bars, `TabControls`, `WebBrowser` controls, `ErrorProvider` components, and menu systems.

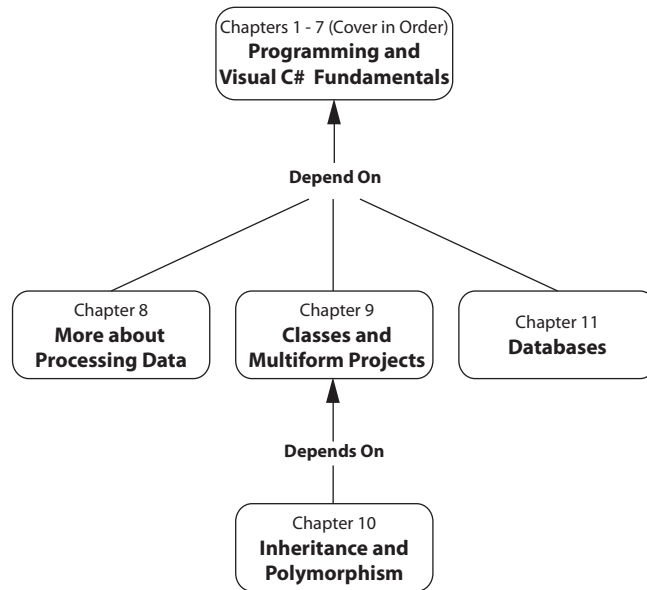
**Appendix C: ASCII/Unicode Characters.** This appendix lists the ASCII (American Standard Code for Information Interchange) character set, which is also the Latin Subset of Unicode.

**Appendix D: Answers to Checkpoint Questions.** This appendix provides the answers to the Checkpoint questions that appear throughout each chapter in the book.

## Organization of the Text

The text teaches Visual C# step by step. Each chapter covers a major set of programming topics, introduces controls and GUI elements, and builds knowledge as the student progresses through the book. Although the chapters can be easily taught in their existing sequence, there is some flexibility. Figure P-1 shows the chapter dependencies. As shown in the figure, Chapters 1–7 present the fundamentals of Visual C# programming and should be covered in sequence. Then, you can move directly to Chapter 8, Chapter 9, or Chapter 11. Chapter 10 should be covered after Chapter 9.

Figure P-1 Chapter dependencies



## Features of the Text

**Concept Statements.** Each major section of the text starts with a concept statement. This statement concisely summarizes the main point of the section.



**Tutorials.** Each chapter has several hands-on tutorials that guide the student through the development of an application. Each tutorial provides detailed, step-by-step instructions, as well as the application's completed code and screen captures of the completed forms.

**Example Programs.** Each chapter has an abundant number of code examples designed to highlight the current topic.



**Notes.** Notes appear at several places throughout the text. They are short explanations of interesting or often misunderstood points relevant to the topic at hand.



**Tips.** Tips advise the student on the best techniques for approaching different programming or animation problems.



**Warnings.** Warnings caution students about programming techniques or practices that can lead to malfunctioning programs or lost data.



**Checkpoints.** Checkpoints are questions placed at intervals throughout each chapter. They are designed to query the student's knowledge quickly after learning a new topic. The answers to the Checkpoint questions can be found in Appendix D.

**Review Questions.** Each chapter presents a thorough and diverse set of Review Questions. They include Multiple Choice, True/False, Algorithm Workbench, and Short Answer.

**Programming Problems.** Each chapter offers a pool of Programming Problems designed to solidify the student's knowledge of the topics currently being studied.



VideoNote

**VideoNotes.** Each tutorial in the book has an accompanying online VideoNote that can be accessed on the book's companion Web site, at [www.pearsonhighered.com/gaddis](http://www.pearsonhighered.com/gaddis). Students can follow along with the author as he works through each tutorial in the videos. Also, one programming problem at the end of each chapter has an accompanying VideoNote that shows the student how to create the solution.

## Supplements

**Student.** The following supplementary material is available with the book:

- Source code and files required for the chapter tutorials are available at [www.pearsonhighered.com/gaddis](http://www.pearsonhighered.com/gaddis)
- A DVD containing Microsoft Visual Studio 2012 Express for Windows Desktop comes bundled with all new copies of this book.

**Instructor.** The following supplements are available to qualified instructors:

- Answers to all Review Questions in the text
- Solutions for all Programming Problems in the text
- Completed versions of all tutorials
- PowerPoint presentation slides for every chapter
- Test bank

For information on how to access these supplements, visit the Pearson Education Instructor Resource Center at [www.pearsonhighered.com/irc](http://www.pearsonhighered.com/irc) or e-mail [computing@pearson.com](mailto:computing@pearson.com).

## Acknowledgments

I would like to thank my family and friends for their love and support in all my many projects. Thanks also go to Chris Rich for his work on the supplements. I am extremely fortunate to have Matt Goldstein as my editor and Jenah Blitz-Stoehr as editorial assistant. Matt and Jenah's support and encouragement make it a pleasure to write chapters and meet deadlines. I am also fortunate to have Yez Alayan as marketing manager and Kathryn Ferranti as marketing coordinator. They do a great job getting my books out to the academic community. I had a great production team, led by Kayla Smith-Tarbox, working tirelessly to bring this book from manuscript to print. Thanks to you all!

## About the Author

**Tony Gaddis** is the principal author of the *Starting Out With* series of textbooks. Tony has nearly 20 years experience teaching computer science courses at Haywood Community College in North Carolina. He is a highly acclaimed instructor who was previously selected as the North Carolina Community College Teacher of the Year and has received the Teaching Excellence award from the National Institute for Staff and Organizational Development.

The *Starting Out With* series includes introductory books using the C++ programming language, the Java™ programming language, Microsoft® Visual Basic®, Microsoft® C#®, Python, Programming Logic and Design, and Alice, all published by the Addison-Wesley imprint of Pearson Education.



# Attention Students

## Installing Visual C#

To complete the tutorials and programming problems in this book, you need to install Visual C# 2012 on your computer. When purchased new, this textbook is packaged with a Microsoft DVD that contains **Visual Studio 2012 Express for Windows Desktop**. Install this on your computer before starting any of the book's tutorials.

If your book does not have the accompanying Microsoft DVD, you can download Visual Studio 2012 Express for Windows Desktop from the following Web site:

<http://www.microsoft.com/express/Downloads/>



**NOTE:** If you are working in your school's computer lab, there is a good chance that **Microsoft Visual Studio** has been installed, rather than Visual Studio Express. If this is the case, your instructor will show you how to start Visual Studio. The tutorials in this book can be completed with either Visual Studio 2012 or Visual Studio 2012 Express for Windows Desktop.

## Installing the Student Sample Program Files

The Student Sample Program files that accompany this book are available for download from the book's companion Web site at:

<http://www.pearsonhighered.com/gaddis>

These files are required for many of the book's tutorials. Simply download the Student Sample Program files to a location on your hard drive where you can easily access them.

# Introduction to Computers and Programming

## TOPICS

- |                               |  |
|-------------------------------|--|
| 1.1 Introduction              | 1.6 Objects  |
| 1.2 Hardware and Software     | 1.7 The Program Development Process                    |
| 1.3 How Computers Store Data  | 1.8 Getting Started with the Visual Studio Environment |
| 1.4 How a Program Works       |  |
| 1.5 Graphical User Interfaces |  |

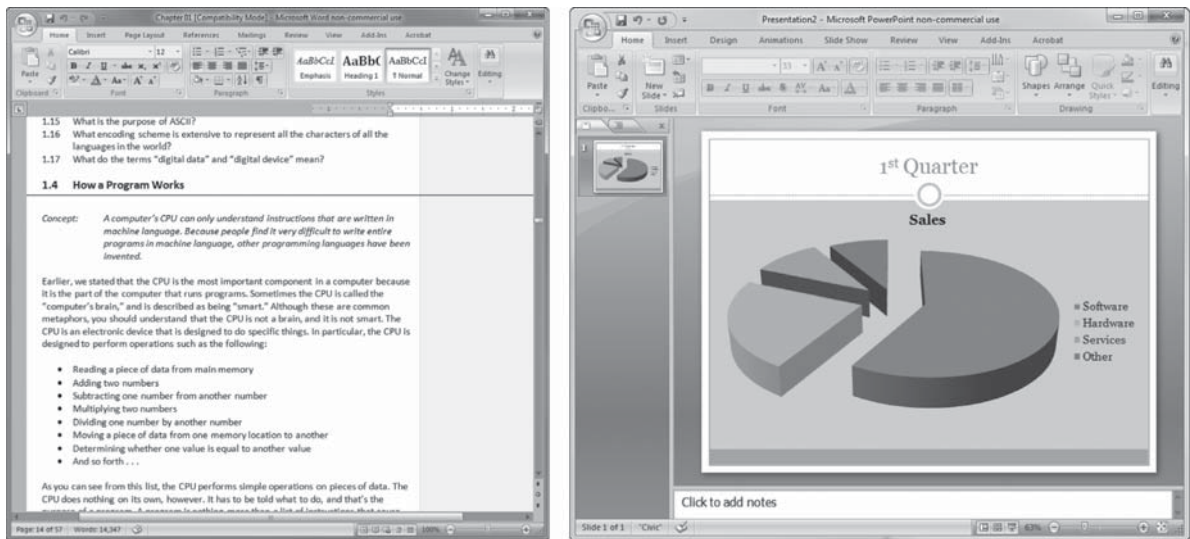
## 1.1

### Introduction

Think about some of the different ways that people use computers. In school, students use computers for tasks such as writing papers, searching for articles, sending e-mail, and participating in online classes. At work, people use computers to analyze data, make presentations, conduct business transactions, communicate with customers and coworkers, control machines in manufacturing facilities, and do many other things. At home, people use computers for tasks such as paying bills, shopping online, staying connected with friends and family, and playing computer games. And don't forget that smart phones, iPods®, car navigation systems, and many other devices are computers as well. The uses of computers are almost limitless in our everyday lives.

Computers can do such a wide variety of things because they can be programmed, which means that computers are designed not to do just one job, but to do any job that their programs tell them to do. A **program** is a set of instructions that a computer follows to perform a task. For example, Figure 1-1 shows screens from two commonly used Microsoft programs: Word and PowerPoint. Word is a word processing program that allows you to create, edit, and print documents. PowerPoint allows you to create graphical slides and use them as part of a presentation.

Programs are commonly referred to as **software**. Software is essential to a computer because without software, a computer can do nothing. All the software that makes our computers useful is created by individuals known as programmers, or software developers. A **programmer**, or **software developer**, is a person with the training and skills necessary to design, create, and test computer programs. Computer programming is an exciting and rewarding career. Today, programmers work in business, medicine, government, law enforcement, agriculture, academics, entertainment, and almost every other field.

**Figure 1-1** A word processing program and a presentation program

This book introduces you to the fundamental concepts of computer programming using the C# programming language. Before we begin exploring those concepts, you need to understand a few basic things about computers and how they work. This chapter provides a solid foundation of knowledge that you will continually rely on as you study computer science. First, we discuss the physical components that computers are commonly made of. Then, we look at how computers store data and execute programs. Next, we introduce you to two fundamental elements of modern software design: graphical user interfaces and objects. Finally, we give a quick introduction to the software used to write C# programs.

## 1.2 Hardware and Software

**CONCEPT:** The physical devices that a computer is made of are referred to as the computer's hardware. The programs that run on a computer are referred to as software.

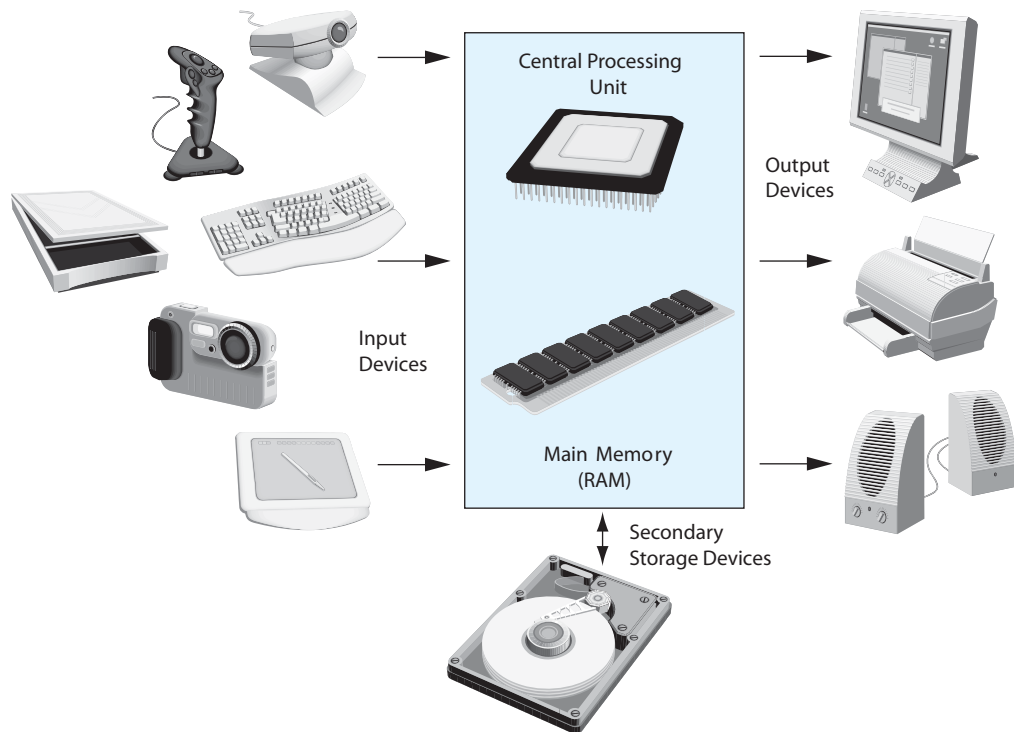
### Hardware

**Hardware** refers to all the physical devices, or components, of which a computer is made. A computer is not one single device but is a system of devices that all work together. Like the different instruments in a symphony orchestra, each device in a computer plays its own part.

If you have ever shopped for a computer, you have probably seen sales literature listing components such as microprocessors, memory, disk drives, video displays, graphics cards, and so on. Unless you already know a lot about computers or at least have a friend who does, understanding what these different components do can be confusing. As shown in Figure 1-2, a typical computer system consists of the following major components:

- The central processing unit (CPU)
- Main memory
- Secondary storage devices
- Input devices
- Output devices

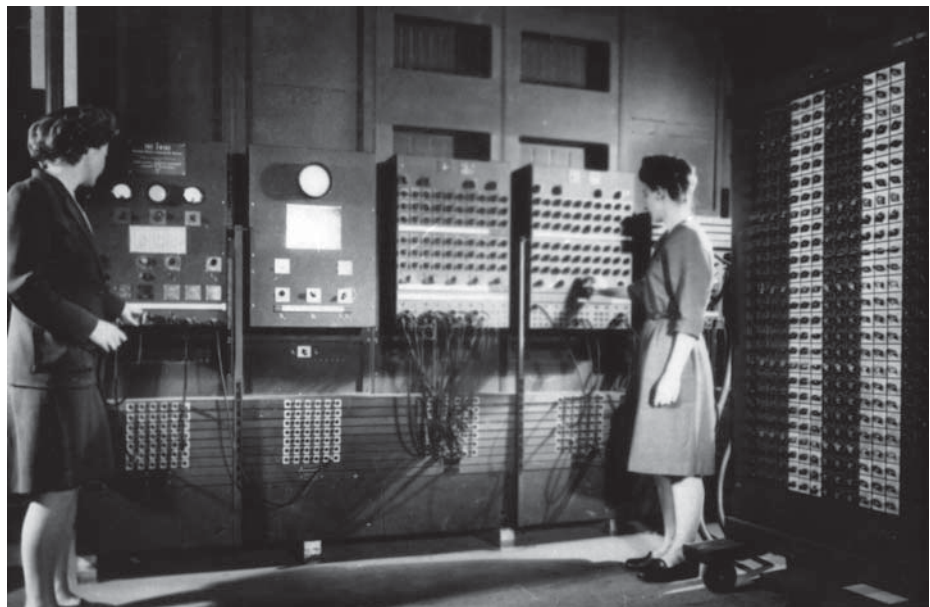
Let's take a closer look at each of these components.

**Figure 1-2** Typical components of a computer system

### The CPU

When a computer is performing the tasks that a program tells it to do, we say that the computer is **running** or **executing** the program. The **central processing unit**, or **CPU**, is the part of a computer that actually runs programs. The CPU is the most important component in a computer because without it, the computer could not run software.

In the earliest computers, CPUs were huge devices made of electrical and mechanical components such as vacuum tubes and switches. Figure 1-3 shows such a device. The two

**Figure 1-3** The ENIAC computer

women in the photo are working with the historic ENIAC computer. The ENIAC, considered by many to be the world's first programmable electronic computer, was built in 1945 to calculate artillery ballistic tables for the U.S. Army. This machine, which was primarily one big CPU, was 8 feet tall and 100 feet long and weighed 30 tons.

Today, CPUs are small chips known as **microprocessors**. Figure 1-4 shows a photo of a lab technician holding a modern-day microprocessor. In addition to being much smaller than the old electromechanical CPUs in early computers, microprocessors are also much more powerful.

**Figure 1-4** A lab technician holds a modern microprocessor



### Main Memory

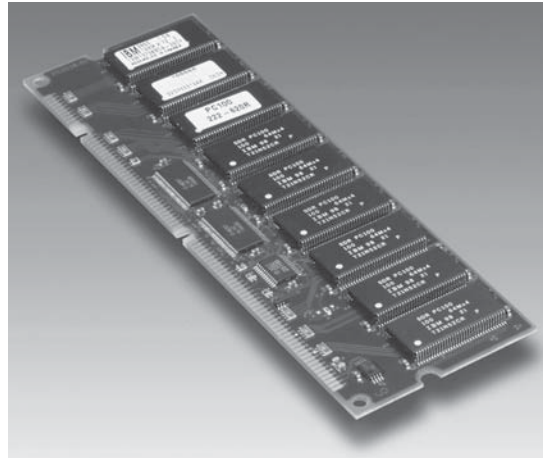
You can think of **main memory** as the computer's work area. This is where the computer stores a program while the program is running, as well as the data that the program is working with. For example, suppose you are using a word processing program to write an essay for one of your classes. While you do this, both the word processing program and the essay are stored in main memory.

Main memory is commonly known as **random-access memory**, or **RAM**. It is called this because the CPU is able to quickly access data stored at any random location in RAM. RAM is usually a **volatile** type of memory that is used only for temporary storage while a program is running. When the computer is turned off, the contents of RAM are erased. Inside your computer, RAM is stored in chips, similar to the ones shown in Figure 1-5.

### Secondary Storage Devices

**Secondary storage** is a type of memory that can hold data for long periods of time, even when there is no power to the computer. Programs are normally stored in secondary memory and loaded into main memory as needed. Important data, such as word processing documents, payroll data, and inventory records, is saved to secondary storage as well.

The most common type of secondary storage device is the disk drive. A **disk drive** stores data by magnetically encoding it onto a circular disk. Most computers have a disk drive mounted inside their case. External disk drives, which connect to one of the computer's

**Figure 1-5** Memory chips

communication ports, are also available. External disk drives can be used to create backup copies of important data or to move data to another computer.

In addition to external disk drives, many types of devices have been created for copying data and for moving it to other computers. For many years floppy disk drives were popular. A **floppy disk drive** records data onto a small floppy disk, which can be removed from the drive. Floppy disks have many disadvantages, however. For example, they have limited storage capacity and are slow to access data. The use of floppy disk drives has declined dramatically in recent years in favor of superior devices such as USB drives. **Universal serial bus (USB) drives** are small devices that plug into the computer's USB port and appear to the system as disk drives. These drives do not actually contain a disk, however. They store data in a special type of memory known as flash memory. USB drives, which are also known as memory sticks and flash drives, are inexpensive, reliable, and small enough to be carried in a pocket.

Optical devices such as the **compact disc (CD)** and the **digital versatile disc (DVD)** are also popular for data storage. Data is not recorded magnetically on an optical disc but is encoded as a series of pits on the disc surface. CD and DVD drives use a laser to detect the pits and thus read the encoded data. Optical discs hold large amounts of data, and because recordable CD and DVD drives are now commonplace, they are good mediums for creating backup copies of data.

### **Input Devices**

**Input** is any data the computer collects from people and from other devices. The component that collects the data and sends it to the computer is called an **input device**. Common input devices are the keyboard, mouse, scanner, microphone, and digital camera. Disk drives and optical drives can also be considered input devices because programs and data are retrieved from them and loaded into the computer's memory.

### **Output Devices**

**Output** is any data the computer produces for people or for other devices. It might be a sales report, a list of names, or a graphic image. The data is sent to an **output device**, which formats and presents it. Common output devices are video displays and printers. Disk drives and CD or DVD recorders can also be considered output devices because the system sends data to them in order to be saved.

## Software

If a computer is to function, software is not optional. Everything that a computer does, from the time you turn the power switch on until you shut the system down, is under the control of software. There are two general categories of software: system software and application software. Most computer programs clearly fit into one of these two categories. Let's take a closer look at each.

### System Software

The programs that control and manage the basic operations of a computer are generally referred to as **system software**. System software typically includes the following types of programs:

#### Operating Systems

An **operating system** is the most fundamental set of programs on a computer. The operating system controls the internal operations of the computer's hardware, manages all the devices connected to the computer, allows data to be saved to and retrieved from storage devices, and allows other programs to run on the computer.

#### Utility Programs

A **utility program** performs a specialized task that enhances the computer's operation or safeguards data. Examples of utility programs are virus scanners, file-compression programs, and data-backup programs.

#### Software Development Tools

The software tools that programmers use to create, modify, and test software are referred to as **software development tools**. Assemblers, compilers, and interpreters, which are discussed later in this chapter, are examples of programs that fall into this category.

### Application Software

Programs that make a computer useful for everyday tasks are known as **application software**. These are the programs that people normally spend most of their time running on their computers. Figure 1-1, at the beginning of this chapter, shows screens from two commonly used applications—Microsoft Word, a word processing program, and Microsoft Powerpoint, a presentation program. Some other examples of application software are spreadsheet programs, e-mail programs, Web browsers, and game programs.



### Checkpoint

- 1.1 What is a program?
- 1.2 What is hardware?
- 1.3 List the five major components of a computer system.
- 1.4 What part of the computer actually runs programs?
- 1.5 What part of the computer serves as a work area to store a program and its data while the program is running?
- 1.6 What part of the computer holds data for long periods of time, even when there is no power to the computer?
- 1.7 What part of the computer collects data from people and from other devices?
- 1.8 What part of the computer formats and presents data for people or other devices?

- 1.9 What fundamental set of programs control the internal operations of the computer's hardware?
- 1.10 What do you call a program that performs a specialized task, such as a virus scanner, a file-compression program, or a data-backup program?
- 1.11 Word processing programs, spreadsheet programs, e-mail programs, Web browsers, and game programs belong to what category of software?

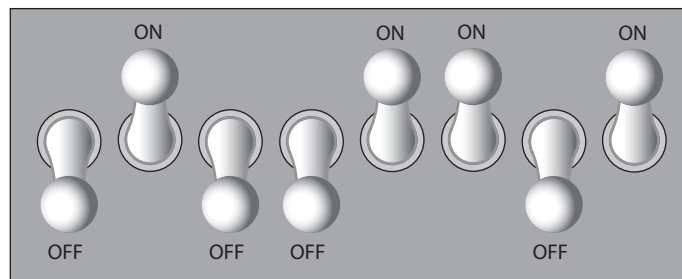
## 1.3 How Computers Store Data

**CONCEPT:** All data stored in a computer is converted to sequences of 0s and 1s.

A computer's memory is divided into tiny storage locations known as bytes. One **byte** is enough memory to store only a letter of the alphabet or a small number. In order to do anything meaningful, a computer has to have lots of bytes. Most computers today have millions, or even billions, of bytes of memory.

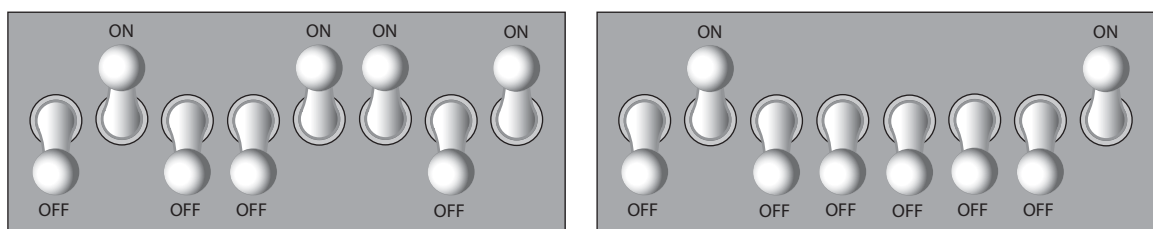
Each byte is divided into eight smaller storage locations known as bits. The term **bit** stands for **binary digit**. Computer scientists usually think of bits as tiny switches that can be either on or off. Bits aren't actual "switches," however, at least not in the conventional sense. In most computer systems, bits are tiny electrical components that can hold either a positive or a negative charge. Computer scientists think of a positive charge as a switch in the *on* position and a negative charge as a switch in the *off* position. Figure 1-6 shows the way that a computer scientist might think of a byte of memory: as a collection of switches that are each flipped to either the on or the off position.

**Figure 1-6** A byte thought of as eight switches



When a piece of data is stored in a byte, the computer sets the eight bits to an on/off pattern that represents the data. For example, the pattern shown on the left in Figure 1-7 shows how the number 77 would be stored in a byte, and the pattern on the right shows how the letter A would be stored in a byte. In a moment you will see how these patterns are determined.

**Figure 1-7** Bit patterns for the number 77 and the letter A



The number 77 stored in a byte.

The letter A stored in a byte.



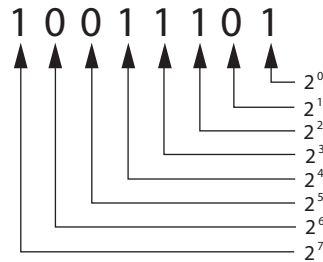
## Storing Numbers

A bit can be used in a very limited way to represent numbers. Depending on whether the bit is turned on or off, it can represent one of two different values. In computer systems, a bit that is turned off represents the number 0 and a bit that is turned on represents the number 1. This corresponds perfectly to the **binary numbering system**. In the binary numbering system (or **binary**, as it is usually called), all numeric values are written as sequences of 0s and 1s. Here is an example of a number that is written in binary:

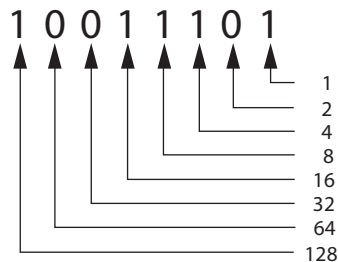
10011101

The position of each digit in a binary number has a value assigned to it. Starting with the rightmost digit and moving left, the position values are  $2^0$ ,  $2^1$ ,  $2^2$ ,  $2^3$ , and so forth, as shown in Figure 1-8. Figure 1-9 shows the same diagram with the position values calculated. Starting with the rightmost digit and moving left, the position values are 1, 2, 4, 8, and so forth.

**Figure 1-8** The values of binary digits as powers of 2



**Figure 1-9** The values of binary digits



To determine the value of a binary number, you simply add up the position values of all the 1s. For example, in the binary number 10011101, the position values of the 1s are 1, 4, 8, 16, and 128. This is shown in Figure 1-10. The sum of all these position values is 157. So, the value of the binary number 10011101 is 157.

**Figure 1-10** Determining the value of 10011101

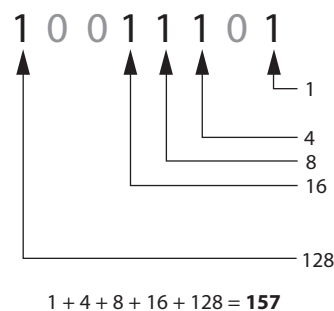
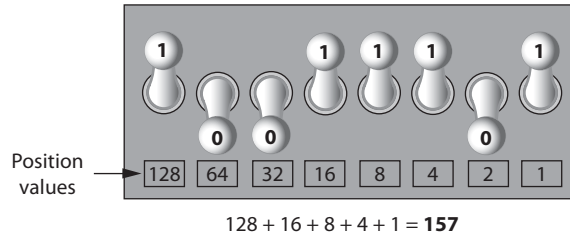


Figure 1-11 shows how you can picture the number 157 stored in a byte of memory. Each 1 is represented by a bit in the on position, and each 0 is represented by a bit in the off position.

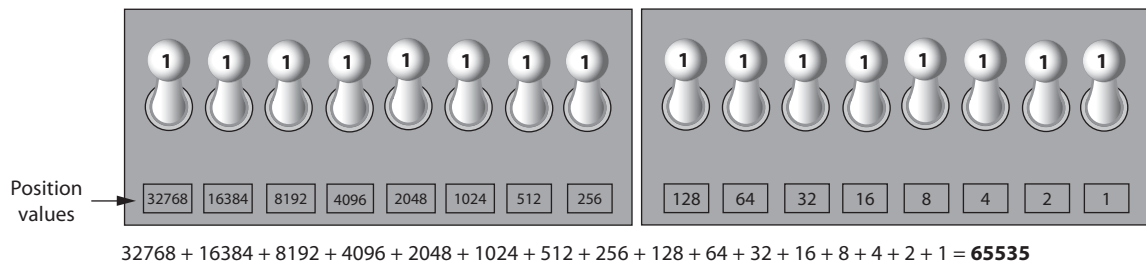
**Figure 1-11** The bit pattern for 157



When all the bits in a byte are set to 0 (turned off), then the value of the byte is 0. When all the bits in a byte are set to 1 (turned on), then the byte holds the largest value that can be stored in it. The largest value that can be stored in a byte is  $1 + 2 + 4 + 8 + 16 + 32 + 64 + 128 = 255$ . This limit exists because there are only eight bits in a byte.

What if you need to store a number larger than 255? The answer is simple: use more than 1 byte. For example, suppose we put 2 bytes together. That gives us 16 bits. The position values of those 16 bits would be  $2^0, 2^1, 2^2, 2^3$ , and so forth, up through  $2^{15}$ . As shown in Figure 1-12, the maximum value that can be stored in 2 bytes is 65,535. If you need to store a number larger than this, then more bytes are necessary.

**Figure 1-12** Two bytes used for a large number



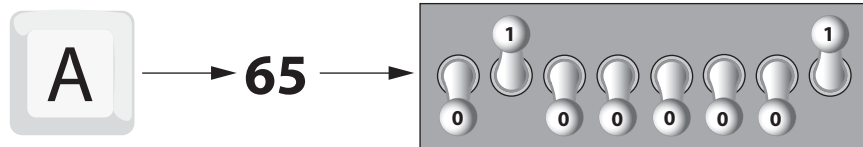
**TIP:** In case you're feeling overwhelmed by all this, relax! You will not have to actually convert numbers to binary while programming. Knowing that this process is taking place inside the computer will help you as you learn, and in the long term this knowledge will make you a better programmer.

## Storing Characters

Any piece of data that is stored in a computer's memory must be stored as a binary number. That includes characters such as letters and punctuation marks. When a character is stored in memory, it is first converted to a numeric code. The numeric code is then stored in memory as a binary number.

Over the years, different coding schemes have been developed to represent characters in computer memory. Historically, the most important of these coding schemes is **ASCII**, which stands for the **American Standard Code for Information Interchange**. ASCII is a set of 128 numeric codes that represent the English letters, various punctuation marks, and other characters. For example, the ASCII code for the uppercase letter A is 65. When you type an uppercase A on your computer keyboard, the number 65 is stored in memory (as a binary number, of course). This is shown in Figure 1-13.

**Figure 1-13** The letter A stored in memory as the number 65



**TIP:** The acronym ASCII is pronounced “askee.”

In case you are curious, the ASCII code for uppercase B is 66, for uppercase C is 67, and so forth. Appendix C shows all the ASCII codes and the characters they represent.

The ASCII character set was developed in the early 1960s and was eventually adopted by almost all computer manufacturers. ASCII is limited, however, because it defines codes for only 128 characters. To remedy this, the Unicode character set was developed in the early 1990s. **Unicode** is an extensive encoding scheme that is compatible with ASCII and can also represent the characters of many of the world’s languages. Today, Unicode is quickly becoming the standard character set used in the computer industry.

## Advanced Number Storage

Earlier you saw how numbers are stored in memory. Perhaps it occurred to you then that the binary numbering system can be used to represent only integer numbers, beginning with 0. Negative numbers and real numbers (such as 3.14159) cannot be represented using the simple binary numbering technique we discussed.

Computers are able to store negative numbers and real numbers in memory, but to do so they use encoding schemes along with the binary numbering system. Negative numbers are encoded using a technique known as **two’s complement**, and real numbers are encoded in **floating-point notation**. You don’t need to know how these encoding schemes work, only that they are used to convert negative numbers and real numbers to binary format.

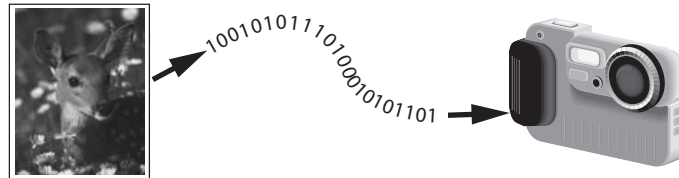
## Other Types of Data

Computers are often referred to as digital devices. The term **digital** can be used to describe anything that uses binary numbers. **Digital data** is data that is stored in binary, and a **digital device** is any device that works with binary data. In this section we have discussed how numbers and characters are stored in binary, but computers also work with many other types of digital data.

For example, consider the pictures that you take with your digital camera. These images are composed of tiny dots of color known as **pixels**. (The term pixel stands for **picture element**.)

As shown in Figure 1-14, each pixel in an image is converted to a numeric code that represents the pixel's color. The numeric code is stored in memory as a binary number.

**Figure 1-14** A digital image stored in binary format



The music that you play on your CD player, iPod, or MP3 player is also digital. A digital song is broken into small pieces known as **samples**. Each sample is converted to a binary number, which can be stored in memory. The more samples that a song is divided into, the more it sounds like the original music when it is played back. A CD-quality song is divided into more than 44,000 samples per second!

### Checkpoint

- 1.12 What amount of memory is enough to store a letter of the alphabet or a small number?
- 1.13 What do you call a tiny “switch” that can be set to either on or off?
- 1.14 In what numbering system are all numeric values written as sequences of 0s and 1s?
- 1.15 What is the purpose of ASCII?
- 1.16 What encoding scheme is extensive enough to represent all the characters of many of the languages in the world?
- 1.17 What do the terms *digital data* and *digital device* mean?

## 1.4 How a Program Works

**CONCEPT:** A computer's CPU can understand only instructions written in machine language. Because people find it very difficult to write entire programs in machine language, other programming languages have been invented.

Earlier, we stated that the CPU is the most important component in a computer because it is the part of the computer that runs programs. Sometimes the CPU is called the “computer's brain” and is described as being “smart.” Although these are common metaphors, you should understand that the CPU is not a brain, and it is not smart. The CPU is an electronic device that is designed to do specific things. In particular, the CPU is designed to perform operations such as the following:

- Reading a piece of data from main memory
- Adding two numbers
- Subtracting one number from another number
- Multiplying two numbers
- Dividing one number by another number
- Moving a piece of data from one memory location to another
- Determining whether one value is equal to another value.

As you can see from this list, the CPU performs simple operations on pieces of data. The CPU does nothing on its own, however. It has to be told what to do, which is the purpose of a program. A program is nothing more than a list of instructions that cause the CPU to perform operations.

Each instruction in a program is a command that tells the CPU to perform a specific operation. Here's an example of an instruction that might appear in a program:

```
10110000
```

To you and me, this is only a series of 0s and 1s. To a CPU, however, this is an instruction to perform an operation.<sup>1</sup> It is written in 0s and 1s because CPUs understand only instructions that are written in **machine language**, and machine language instructions are always written in binary.

A machine language instruction exists for each operation that a CPU is capable of performing. For example, there is an instruction for adding numbers; there is an instruction for subtracting one number from another; and so forth. The entire set of instructions that a CPU can execute is known as the CPU's **instruction set**.



**NOTE:** There are several microprocessor companies today that manufacture CPUs. Some of the more well-known microprocessor companies are Intel, AMD, and Motorola. If you look carefully at your computer, you might find a tag showing a logo for its microprocessor.

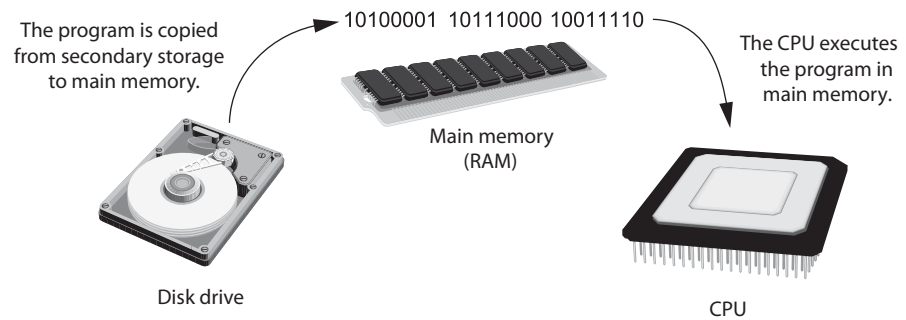
Each brand of microprocessor has its own unique instruction set, which is typically understood only by microprocessors of the same brand. For example, Intel microprocessors understand the same instructions, but they do not understand instructions for Motorola microprocessors.

The machine language instruction that was previously shown is an example of only one instruction. It takes a lot more than one instruction, however, for the computer to do anything meaningful. Because the operations that a CPU knows how to perform are so basic in nature, a meaningful task can be accomplished only if the CPU performs many operations. For example, if you want your computer to calculate the amount of interest that you will earn from your savings account this year, the CPU will have to perform a large number of instructions, carried out in the proper sequence. It is not unusual for a program to contain thousands or even a million or more machine language instructions.

Programs are usually stored on a secondary storage device such as a disk drive. When you install a program on your computer, the program is typically copied to your computer's disk drive from a CD-ROM or perhaps downloaded from a Web site.

Although a program can be stored on a secondary storage device such as a disk drive, it has to be copied into main memory, or RAM, each time the CPU executes it. For example, suppose you have a word processing program on your computer's disk. To execute the program, you use the mouse to double-click the program's icon. This causes the program to be copied from the disk into main memory. Then, the computer's CPU executes the copy of the program that is in main memory. This process is illustrated in Figure 1-15.

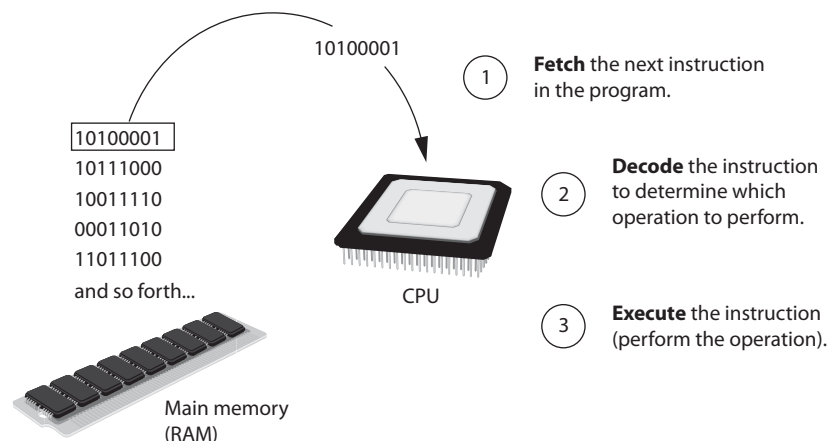
<sup>1</sup>The example shown is an actual instruction for an Intel microprocessor. It tells the microprocessor to move a value into the CPU.

**Figure 1-15** A program being copied into main memory and then executed

When a CPU executes the instructions in a program, it is engaged in a process that is known as the **fetch-decode-execute cycle**. This cycle, which consists of three steps, is repeated for each instruction in the program. The steps are as follows:

1. **Fetch** A program is a long sequence of machine language instructions. The first step of the cycle is to fetch, or read, the next instruction from memory into the CPU.
2. **Decode** A machine language instruction is a binary number that represents a command that tells the CPU to perform an operation. In this step the CPU decodes the instruction that was just fetched from memory, to determine which operation it should perform.
3. **Execute** The last step in the cycle is to execute, or perform, the operation.

Figure 1-16 illustrates these steps.

**Figure 1-16** The fetch-decode-execute cycle

## From Machine Language to Assembly Language

Computers can execute only programs that are written in machine language. As previously mentioned, a program can have thousands or even a million or more binary instructions, and writing such a program would be very tedious and time consuming. Programming in machine language would also be very difficult because putting a 0 or a 1 in the wrong place would cause an error.

Although a computer's CPU understands only machine language, it is impractical for people to write programs in machine language. For this reason, **assembly language** was

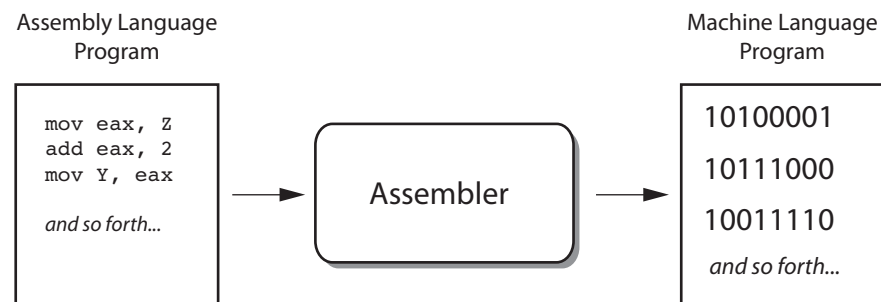
created in the early days of computing<sup>2</sup> as an alternative to machine language. Instead of using binary numbers for instructions, assembly language uses short words that are known as **mnemonics**. For example, in assembly language, the mnemonic `add` typically means to add numbers, `mul` typically means to multiply numbers, and `mov` typically means to move a value to a location in memory. When a programmer uses assembly language to write a program, he or she can write short mnemonics instead of binary numbers.



**NOTE:** There are many different versions of assembly language. It was mentioned earlier that each brand of CPU has its own machine language instruction set. Each brand of CPU typically has its own assembly language as well.

Assembly language programs cannot be executed by the CPU, however. The CPU understands only machine language, so a special program known as an **assembler** is used to translate an assembly language program to a machine language program. This process is shown in Figure 1-17. The CPU can then execute the machine language program that the assembler creates.

**Figure 1-17** An assembler translating an assembly language program to a machine language program



## High-Level Languages

Although assembly language makes it unnecessary to write binary machine language instructions, it is not without difficulties. Assembly language is primarily a direct substitute for machine language, and like machine language, it requires that you know a lot about the CPU. Assembly language also requires that you write a large number of instructions for even the simplest program. Because assembly language is so close in nature to machine language, it is referred to as a **low-level language**.

In the 1950s, a new generation of programming languages known as high-level languages began to appear. A **high-level language** allows you to create powerful and complex programs without knowing how the CPU works and without writing large numbers of low-level instructions. In addition, most high-level languages use words that are easy to understand. For example, if a programmer were using COBOL (which was one of the early high-level languages created in the 1950s), he or she would write the following instruction to display the message *Hello world* on the computer screen:

```
DISPLAY "Hello world"
```

<sup>2</sup>The first assembly language was most likely developed in the 1940s at Cambridge University for use with a historical computer known as the EDSAC.

Doing the same thing in assembly language would require several instructions and an intimate knowledge of how the CPU interacts with the computer's video circuitry. As you can see from this example, high-level languages allow programmers to concentrate on the tasks they want to perform with their programs rather than the details of how the CPU will execute those programs.

Since the 1950s, thousands of high-level languages have been created. Table 1-1 lists several of the more well-known languages.

**Table 1-1** Programming languages

Language	Description
Ada	Ada was created in the 1970s, primarily for applications used by the U.S. Department of Defense. The language is named in honor of Countess Ada Lovelace, an influential and historical figure in the field of computing.
BASIC	Beginners All-purpose Symbolic Instruction Code is a general-purpose language that was originally designed in the early 1960s to be simple enough for beginners to learn. Today, there are many different versions of BASIC.
FORTRAN	FORmula TRANslator was the first high-level programming language. It was designed in the 1950s for performing complex mathematical calculations.
COBOL	Common Business-Oriented Language was created in the 1950s and was designed for business applications.
Pascal	Pascal was created in 1970 and was originally designed for teaching programming. The language was named in honor of the mathematician, physicist, and philosopher Blaise Pascal.
C and C++	C and C++ (pronounced “c plus plus”) are powerful, general-purpose languages developed at Bell Laboratories. The C language was created in 1972, and the C++ language was created in 1983.
C#	Pronounced “c sharp,” this language was created by Microsoft around the year 2000 for developing applications based on the Microsoft .NET platform.
Java	Java was created by Sun Microsystems in the early 1990s. It can be used to develop programs that run on a single computer or over the Internet from a Web server.
JavaScript	JavaScript, created in the 1990s, can be used in Web pages. Despite its name, JavaScript is not related to Java.
Python	Python is a general-purpose language created in the early 1990s. It has become popular in business and academic applications.
Ruby	Ruby is a general-purpose language that was created in the 1990s. It is increasingly becoming a popular language for programs that run on Web servers.
Visual Basic	Visual Basic (commonly known as VB) is a Microsoft programming language and software development environment that allows programmers to create Windows-based applications quickly. VB was originally created in the early 1990s.

## Keywords, Operators, and Syntax: An Overview

Each high-level language has its own set of predefined words that the programmer must use to write a program. The words that make up a high-level programming language are known as **keywords** or **reserved words**. Each keyword has a specific meaning and cannot be used for any other purpose. Table 1-2 shows the keywords in the C# programming language.



**Table 1-2** The C# keywords

abstract	as	base	bool
break	byte	case	catch
char	checked	class	const
continue	decimal	default	delegate
do	double	else	enum
event	explicit	extern	false
finally	fixed	float	for
foreach	goto	if	implicit
in	in	int	interface
internal	is	lock	long
namespace	new	null	object
out	override	operator	params
private	protected	public	readonly
ref	return	sbyte	sealed
short	sizeof	stackalloc	static
string	struct	switch	this
throw	true	try	typeof
uint	ulong	unchecked	unsafe
ushort	using	virtual	void
volatile	while		

In addition to keywords, programming languages have **operators** that perform various operations on data. For example, all programming languages have math operators that perform arithmetic. In C#, as well as most other languages, the + sign is an operator that adds two numbers. The following adds 12 and 75:

```
12 + 75
```

There are numerous other operators in the C# language, many of which you will learn about as you progress through this text.

In addition to keywords and operators, each language also has its own **syntax**, which is a set of rules that must be strictly followed when writing a program. The syntax rules dictate how keywords, operators, and various punctuation characters must be used in a program. When you are learning a programming language, you must learn the syntax rules for that particular language.

The individual instructions that you use to write a program in a high-level programming language are called **statements**. A programming statement can consist of keywords, operators, punctuation, and other allowable programming elements, arranged in the proper sequence to perform an operation.

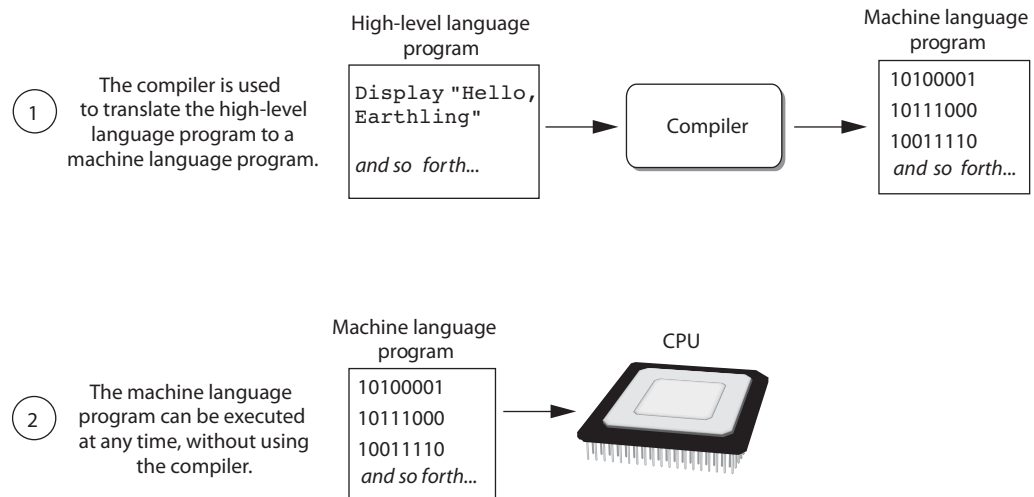
## Compilers and Interpreters

Because the CPU understands only machine language instructions, programs that are written in a high-level language must be translated into machine language. Depending on the language in which a program has been written, the programmer will use either a compiler or an interpreter to make the translation.

A **compiler** is a program that translates a high-level language program into a separate machine language program. The machine language program can then be executed any time it

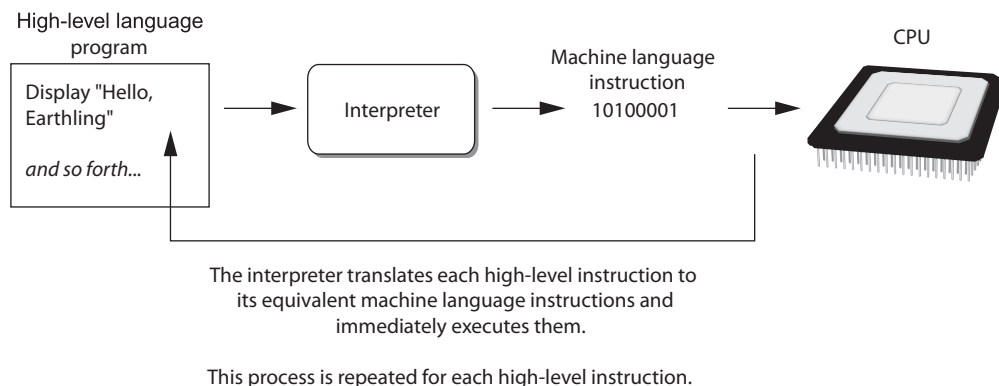
is needed. This is shown in Figure 1-18. As shown in the figure, compiling and executing are two different processes.

**Figure 1-18** Compiling a high-level program and executing it



Some programming languages use an **interpreter**, which is a program that both translates and executes the instructions in a high-level language program. As the interpreter reads each individual instruction in the program, it converts it to a machine language instruction and then immediately executes it. This process repeats for every instruction in the program. This process is illustrated in Figure 1-19. Because interpreters combine translation and execution, they typically do not create separate machine language programs.

**Figure 1-19** Executing a high-level program with an interpreter



The statements that a programmer writes in a high-level language are called **source code**, or simply **code**. Typically, the programmer types a program's code into a text editor and then saves the code in a file on the computer's disk. Next, the programmer uses a compiler to translate the code into a machine language program or an interpreter to translate and execute the code. If the code contains a syntax error, however, it cannot be translated. A **syntax error** is a mistake such as a misspelled keyword, a missing punctuation character, or the incorrect use of an operator. When this happens, the compiler or interpreter displays an error message, indicating that the program contains a syntax error. The programmer corrects the error and then attempts once again to translate the program.



**NOTE:** Human languages also have syntax rules. Do you remember when you took your first English class and you learned all those rules about commas, apostrophes, capitalization, and so forth? You were learning the syntax of the English language.

Although people commonly violate the syntax rules of their native language when speaking and writing, other people usually understand what they mean. Unfortunately, compilers and interpreters do not have this ability. If even a single syntax error appears in a program, the program cannot be compiled or executed.



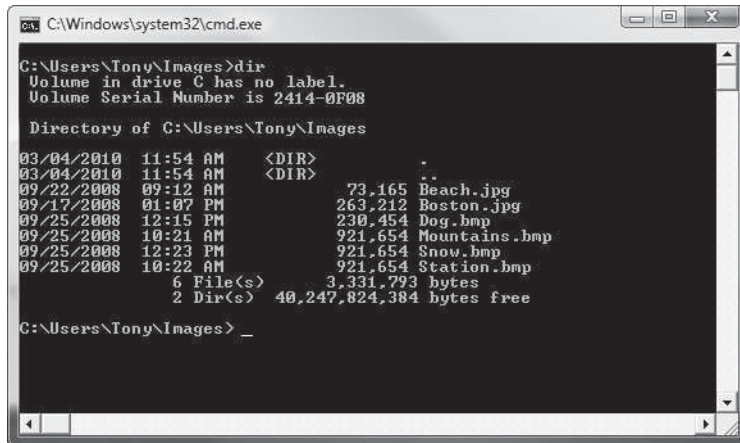
## Checkpoint

- 1.18 A CPU understands instructions that are written only in what language?
- 1.19 A program has to be copied into what type of memory each time the CPU executes it?
- 1.20 When a CPU executes the instructions in a program, it is engaged in what process?
- 1.21 What is assembly language?
- 1.22 What type of programming language allows you to create powerful and complex programs without knowing how the CPU works?
- 1.23 Each language has a set of rules that must be strictly followed when writing a program. What is this set of rules called?
- 1.24 What do you call a program that translates a high-level language program into a separate machine language program?
- 1.25 What do you call a program that both translates and executes the instructions in a high-level language program?
- 1.26 What type of mistake is usually caused by a misspelled keyword, a missing punctuation character, or the incorrect use of an operator?

## 1.5 Graphical User Interfaces

**CONCEPT:** A graphical user interface allows the user to interact with a program using graphical elements such as icons, buttons, and dialog boxes.

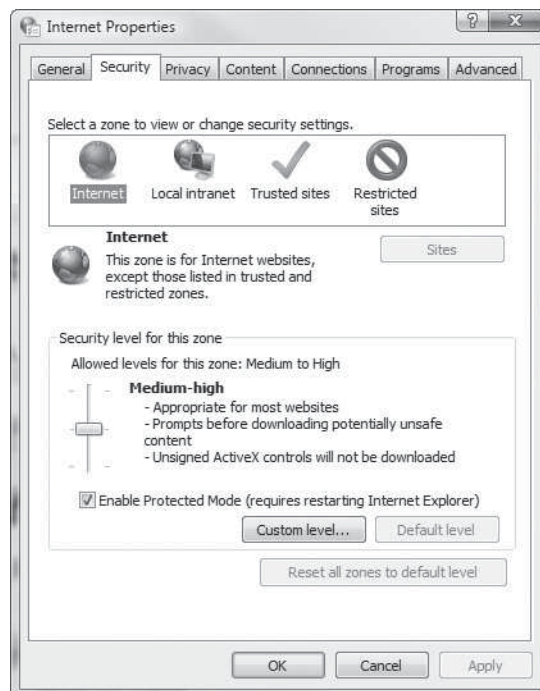
Programmers commonly use the term **user** to describe any hypothetical person that might be using a computer and its programs. A computer's **user interface** is the part of the computer with which the user interacts. One part of the user interface consists of hardware devices, such as the keyboard and the video display. Another part of the user interface involves the way that the computer's operating system and application software accepts commands from the user. For many years, the only way that the user could interact with a computer was through a command line interface. A **command line interface**, which is also known as a **console interface**, requires the user to type commands. If a command is typed correctly, it is executed and the results are displayed. If a command is not typed correctly, an error message is displayed. Figure 1-20 shows the Windows command prompt window, which is an example of a command line interface.

**Figure 1-20** A command line interface

Many computer users, especially beginners, find command line interfaces difficult to use. This is because there are many commands to be learned, and each command has its own syntax, much like a programming statement. If a command isn't entered correctly, it will not work.

In the 1980s, a new type of interface known as a graphical user interface came into use in commercial operating systems. A **graphical user interface**, or GUI (pronounced "goeey"), allows the user to interact with the operating system and application programs through graphical elements on the screen. GUIs also popularized the use of the mouse as an input device. Instead of requiring the user to type commands on the keyboard, GUIs allow the user to point at graphical elements and click the mouse button to activate them.

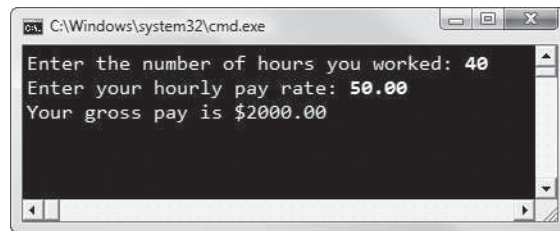
Much of the interaction with a GUI is done through windows that display information and allow the user to perform actions. Figure 1-21 shows an example of a window that allows the user to change the system's Internet settings. Instead of typing cryptic commands, the user interacts with graphical elements such as icons, buttons, and slider bars.

**Figure 1-21** A window in a graphical user interface

## Event-Driven GUI Programs

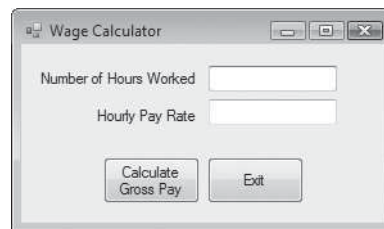
In a text-based environment, such as a command line interface, programs determine the order in which things happen. For example, Figure 1-22 shows the interaction that has taken place in a text environment with a program that calculates an employee's gross pay. First, the program told the user to enter the number of hours worked. In the figure, the user entered 40 and pressed the **Enter** key. Next, the program told the user to enter his or her hourly pay rate. In the figure, the user entered 50.00, and pressed the **Enter** key. Then, the program displayed the user's gross pay. As the program was running, the user had no choice but to enter the data in the order requested.

**Figure 1-22** Interaction with a program in a text environment



In a GUI environment, however, the user determines the order in which things happen. For example, Figure 1-23 shows a GUI program that calculates an employee's gross pay. Notice that there are boxes in which the user enters the number of hours worked and the hourly pay rate. The user can enter the hours and the pay rate in any order he or she wishes. If the user makes a mistake, the user can erase the data that was entered and re-type it. When the user is ready to calculate the area, he or she uses the mouse to click the *Calculate Gross Pay* button and the program performs the calculation.

**Figure 1-23** A GUI program



Because GUI programs must respond to the actions of the user, they are said to be **event driven**. The user causes events, such as the clicking of a button, and the program responds to those events.

This book focuses exclusively on the development of GUI applications using the C# programming language. As you work through this book, you will learn to create applications that interact with the user through windows containing graphical objects. You will also learn how to program your applications to respond to the events that take place as the user interacts with them.

### Checkpoint

- 1.27 What is a user interface?
- 1.28 How does a command line interface work?

1.29 When the user runs a program in a text-based environment, such as the command line, what determines the order in which things happen?

1.30 What is an event-driven program?

## 1.6 Objects

**CONCEPT:** An object is a program component that contains data and performs operations. Programs use objects to perform specific tasks.

Have you ever driven a car? If so, you know that a car is made of a lot of components. A car has a steering wheel, an accelerator pedal, a brake pedal, a gear shifter, a speedometer, and numerous other devices with which the driver interacts. There are also a lot of components under the hood, such as the engine, the battery, the radiator, and so forth. A car is not just one single object, but rather a collection of objects that work together.

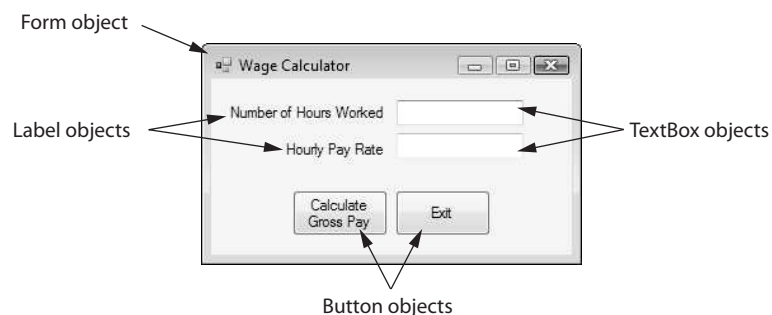
This same notion also applies to computer programming. Most programming languages that are used today are **object oriented**. When you use an object-oriented language, you create programs by putting together a collection of objects. In programming, an object is not a physical device, however, like a steering wheel or a brake pedal. Instead, it is a software component that exists in the computer's memory. In software, an object has two general capabilities:

- An object can store data. The data stored in an object are commonly called **fields**, or **properties**.
- An object can perform operations. The operations that an object can perform are called **methods**.

When you write a program using an object-oriented language, you use objects to accomplish specific tasks. Some objects have a visual part that can be seen on the screen. For example, Figure 1-24 shows the wage-calculator program that we discussed in the previous section. The graphical user interface is made of the following objects:

- |               |   |
|---------------|---|
| Form object   | A window that is displayed on the screen is called a <b>Form object</b> . Figure 1-24 shows a Form object that contains several other graphical objects.  |
| Label objects | A <b>Label object</b> displays text on a form. The form shown in Figure 1-24 contains two Label objects. One of the Label objects displays the text <i>Number of Hours Worked</i> and the other Label object displays the text <i>Hourly Pay Rate</i> . |

**Figure 1-24** Objects used in a GUI



TextBox objects	A <b>TextBox</b> object appears as a rectangular region that can accept keyboard input from the user. The form shown in Figure 1-24 has two TextBox objects: one in which the user enters the number of hours worked and another in which the user enters the hourly pay rate.
Button objects	A <b>Button</b> object appears on a form as a button with a caption written across its face. When the user clicks a Button object with the mouse, an action takes place. The form in Figure 1-24 has two Button objects. One shows the caption <i>Calculate Gross Pay</i> . When the user clicks this button, the program calculates and displays the gross pay. The other button shows the caption <i>Exit</i> . When the user clicks this button, the program ends.

Forms, Labels, TextBoxes, and Buttons are just a few of the objects that you will learn to use in C#. As you study this book, you will create applications that incorporate many different types of objects.

## Visible versus Invisible Objects

Objects that are visible in a program's graphical user interface are commonly referred to as **controls**. We could say that the form shown in Figure 1-24 contains two Label controls, two TextBox controls, and two Button controls. When an object is referred to as a control, it simply means that the object plays a role in a program's graphical user interface.

Not all objects can be seen on the screen, however. Some objects exist only in memory for the purpose of helping your program perform some task. For example, there are objects that read data from files, objects that generate random numbers, objects that store and sort large collections of data, and so forth. These types of objects help your program perform tasks, but they do not directly display anything on the screen. When you are writing a program, you will use objects that can help your program perform its tasks. Some of the objects that you use will be controls (visible in the program's GUI), and other objects will be invisible.

## Classes: Where Objects Come From

Objects are very useful, but they don't just magically appear in your program. Before a specific type of object can be used, that object has to be created in memory. And, before an object can be created in memory, you must have a class for the object.

A **class** is code that describes a particular type of object. It specifies the data that an object can hold (the object's fields and properties), and the actions that an object can perform (the object's methods). You will learn much more about classes as you progress through this book, but for now, just think of a class as a code "blueprint" that can be used to create a particular type of object.

## The .NET Framework

C# is a very popular programming language, but there are a lot of things it cannot do by itself. For example, you cannot use C# alone to create a graphical user interface, read data from files, work with databases, or many of the other things that programs commonly need to do. C# provides only the basic keywords and operators that you need to construct a program.

So, if the C# language doesn't provide the classes and other code necessary for creating GUIs and performing many other advanced operations, where do those classes and code

come from? The answer is the .NET Framework. The **.NET Framework** is a collection of classes and other code that can be used, along with a programming language such as C#, to create programs for the Windows operating system. For example, the .NET Framework provides classes to create Forms, TextBoxes, Labels, Buttons, and many other types of objects.

When you use Visual C# to write programs, you are using a combination of the C# language and the .NET Framework. As you work through this book you will not only learn C#, but you will also learn about many of the classes and other features provided by the .NET Framework.

## Writing Your Own Classes

The .NET Framework provides many prewritten classes ready for use in your programs. There will be times, however, that you will wish you had an object to perform a specific task, and no such class will exist in the .NET Framework. This is not a problem because in C# you can write your own classes that have the specific fields, properties, and methods that you need for any situation. In Chapter 9 you will learn to create classes for the specific objects that you need in your programs.



### Checkpoint

- 1.31 What is an object?
- 1.32 What type of language is used to create programs by putting together a collection of objects?
- 1.33 What two general capabilities does an object have?
- 1.34 What term is commonly used to refer to objects such as TextBoxes, Labels, and Buttons that are visible in a program's graphical user interface?
- 1.35 What is the purpose of an object that cannot be seen on the screen and exists only in memory?
- 1.36 What is a class?
- 1.37 What is the .NET Framework?
- 1.38 Why might you need to write your own classes?

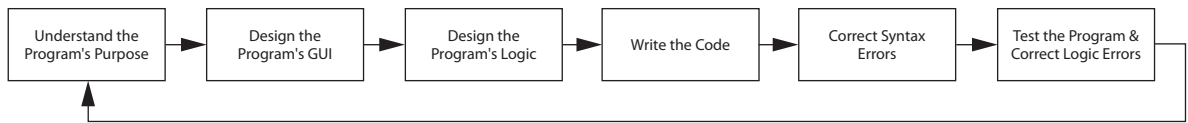
## 1.7 The Program Development Process

**CONCEPT:** Creating a program requires several steps, which include designing the program's logic, creating the user interface, writing code, testing, and debugging.

### The Program Development Cycle

Previously in this chapter you learned that programmers typically use high-level languages such as C# to create programs. There is much more to creating a program than writing code, however. The process of creating a program that works correctly typically requires the six phases shown in Figure 1-25. The entire process is known as the **program development cycle**.



**Figure 1-25** The program development cycle

Let's take a closer look at each stage in the cycle.

### 1. Understand the Program's Purpose

When beginning a new programming project, it is essential that you understand what the program is supposed to do. Most programs perform the following three-step process:

Step 1. Input is received.

Step 2. Some process is performed on the input.

Step 3. Output is produced.

Input is any data that the program receives while it is running. Once input is received, some process, such as a mathematical calculation, is usually performed on it. The results of the process are then sent out of the program as output. If you can identify these three elements of a program (input, process, and output), then you are on your way to understanding what the program is supposed to do.

For example, suppose you have been asked to write a program to calculate and display the gross pay for an hourly paid employee. Here is a summary of the program's input, process, and output:

#### Input:

- Input the number of hours that the employee worked.
- Input the employee's hourly pay rate.

#### Process:

- Multiply the number of hours worked by the hourly pay rate. The result is the employee's gross pay.

#### Output:

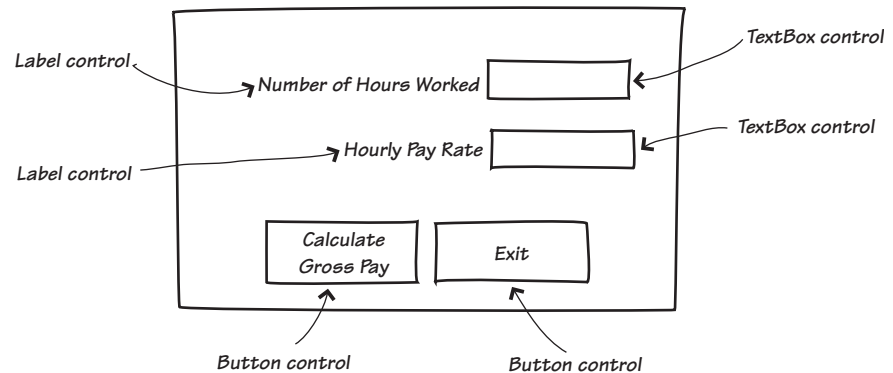
- Display the employee's gross pay on the screen.

### 2. Design the Graphical User Interface (GUI)

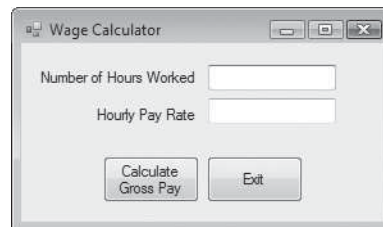
Once you clearly understand what the program is supposed to do, you can begin designing its graphical user interface. Often, you will find it helpful to draw a sketch of each form that the program displays. For example, if you are designing a program that calculates gross pay, Figure 1-26 shows how you might sketch the program's form.

Notice that the sketch identifies each type of control (GUI object) that will appear on the form. The `TextBox` controls will allow the user to enter input. The user will type the number of hours worked into one of the `TextBox`s and the employee's hourly pay rate into the other `TextBox`. Notice that `Label` controls are placed on the form to tell the user what data to enter. When the user clicks the `Button` control that reads *Calculate Gross Pay*, the program will display the employee's gross pay on the screen in a pop-up window. When the user clicks the `Button` control that reads *Exit*, the program will end.

Once you are satisfied with the sketches that you have created for the program's forms, you can begin creating the actual forms on the computer. As a Visual C# programmer, you have a powerful environment known as Visual Studio at your disposal. Visual Studio gives you a "what you see is what you get" editor that allows you to visually design a program's forms. You can use Visual Studio to create the program's

**Figure 1-26** Form sketch

forms, place all the necessary controls on the forms, and set each control's properties so it has the desired appearance. For example, Figure 1-27 shows the actual form that you might create for the wage-calculator program, which calculates gross pay.

**Figure 1-27** Form for the wage-calculator program

### 3. Design the Program's Logic

In this phase you break down each task that the program must perform into a series of logical steps. For example, if you look back at Figure 1-27, notice that the pay-calculating program's form has a Button control that reads *Calculate Gross Pay*. When the user clicks this button, you want the program to display the employee's gross pay. Here are the steps that the program should take to perform that task:

- Step 1. Get the number of hours worked from the appropriate TextBox.
- Step 2. Get the hourly pay rate from the appropriate TextBox.
- Step 3. Calculate the gross pay as the number of hours worked times the hourly pay rate.
- Step 4. Display the gross pay in a pop-up window.

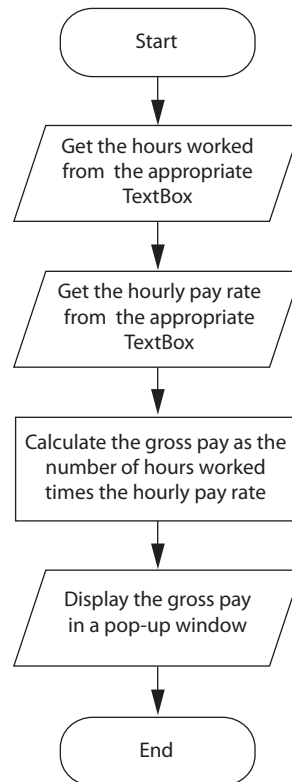
This is an example of an **algorithm**, which is a set of well-defined, logical steps that must be taken to perform a task. An algorithm that is written out in this manner, in plain English statements, is called **pseudocode**. (The word *pseudo* means fake, so pseudocode is fake code.) The process of informally writing out the steps of an algorithm in pseudocode before attempting to write any actual code is very helpful when

you are designing a program. Because you do not have to worry about breaking any syntax rules, you can focus on the logical steps that the program must perform.

Flowcharting is another tool that programmers use to design programs. A **flowchart** is a diagram that graphically depicts the steps of an algorithm. Figure 1-28 shows how you might create a flowchart for the wage-calculator algorithm. Notice that there are three types of symbols in the flowchart: ovals, parallelograms, and a rectangle. Each of these symbols represents a step in the algorithm, as described here:

- The ovals, which appear at the top and bottom of the flowchart, are called **terminal symbols**. The **Start terminal** symbol marks the program’s starting point and the **End terminal** symbol marks the program’s ending point.
- Parallelograms are used as **input symbols** and **output symbols**. They represent steps in which the program reads input or displays output.
- Rectangles are used as **processing symbols**. They represent steps in which the program performs some process on data, such as a mathematical calculation.

**Figure 1-28** Flowchart for the wage-calculator program



The symbols are connected by arrows that represent the “flow” of the program. To step through the symbols in the proper order, you begin at the *Start* terminal and follow the arrows until you reach the *End* terminal.

#### 4. Write the Code

Once you have created a program’s GUI and designed algorithms for the program’s tasks, you are ready to start writing code. During this process, you will refer to the pseudocode or flowcharts that you created in Step 3 and use Visual Studio to write C# code.

### 5. Correct Syntax Errors

You previously learned in this chapter that a programming language such as C# has rules, known as syntax, that must be followed when writing a program. A language's syntax rules dictate things such as how keywords, operators, and punctuation characters can be used. A syntax error occurs if the programmer violates any of these rules. If the program contains a syntax error or even a simple mistake such as a misspelled keyword, the program cannot be compiled or executed.

Virtually all code contains syntax errors when it is first written, so the programmer will typically spend some time correcting these. Once all the syntax errors and simple typing mistakes have been corrected, the program can be compiled and translated into an executable program.

### 6. Test the Program and Correct Logic Errors

Once the code is in an executable form, you must then test it to determine whether any logic errors exist. A **logic error** is a mistake that does not prevent the program from running but causes it to produce incorrect results. (Mathematical mistakes are common causes of logic errors.) If the program produces incorrect results, the programmer must **debug** the code. This means that the programmer finds and corrects logic errors in the program. Sometimes, during this process, the programmer discovers that the program's original design must be changed. In this event, the program development cycle starts over and continues until no errors can be found.



## Checkpoint

- 1.39 List the six steps in the program development cycle.
- 1.40 What is an algorithm?
- 1.41 What is pseudocode?
- 1.42 What is a flowchart?
- 1.43 What do each of the following symbols mean in a flowchart?
  - Oval
  - Parallelogram
  - Rectangle

## 1.8

# Getting Started with the Visual Studio Environment

**CONCEPT:** Visual Studio and Visual Studio Express for Windows Desktop consist of tools that you use to build Visual C# applications. The first step in using Visual C# is learning about these tools.

To follow the tutorials in this book, and create Visual C# applications, you will need to install either Visual Studio 2012 or Visual Studio 2012 Express for Windows Desktop on your computer. **Visual Studio 2012** is a professional **integrated development environment (IDE)**, which means that it provides all the necessary tools for creating, testing, and debugging software. It can be used to create applications not only with Visual C#, but also with other languages such as Visual Basic and C++. If you are using a school's computer lab, there's a good chance that Visual Studio 2012 has been installed.

If you do not have access to Visual Studio 2012, you can install **Visual Studio 2012 Express for Windows Desktop**, a free programming environment that is available for download from the Microsoft Web site. (When this book is purchased new, it has an accompanying Microsoft DVD that contains Visual Studio 2012 Express for Windows Desktop.)

For the purposes of this book, it does not matter whether you are using Visual Studio 2012 or Visual Studio 2012 Express for Windows Desktop. Both products look very similar and work in a similar manner. When there are differences, the book will alert you. To keep things simple, this book will use the term **Visual Studio** to refer to either Visual Studio 2012 or Visual Studio 2012 Express for Windows Desktop. When you are instructed to use Visual Studio to perform some task, use the system that is installed on your computer.

Visual Studio is a customizable environment. If you are working in your school's computer lab, there's a chance that someone else has customized the programming environment to suit his or her own preferences. If this is the case, the screens that you see may not match exactly the ones shown in this book. For that reason it's a good idea to reset the programming environment before you create a Visual C# application. Tutorial 1-1 guides you through the process.



## Tutorial 1-1: Starting Visual Studio and Setting Up the Environment



VideoNote

**Tutorial 1-1:**  
Starting  
Visual Studio  
and Setting  
Up the  
Environment

**Step 1:** Find out from your instructor whether you are using Visual Studio 2012 or Visual Studio 2012 Express for Windows Desktop. Then, click the *Start* button, open the *All Programs* menu, and perform one of the following:

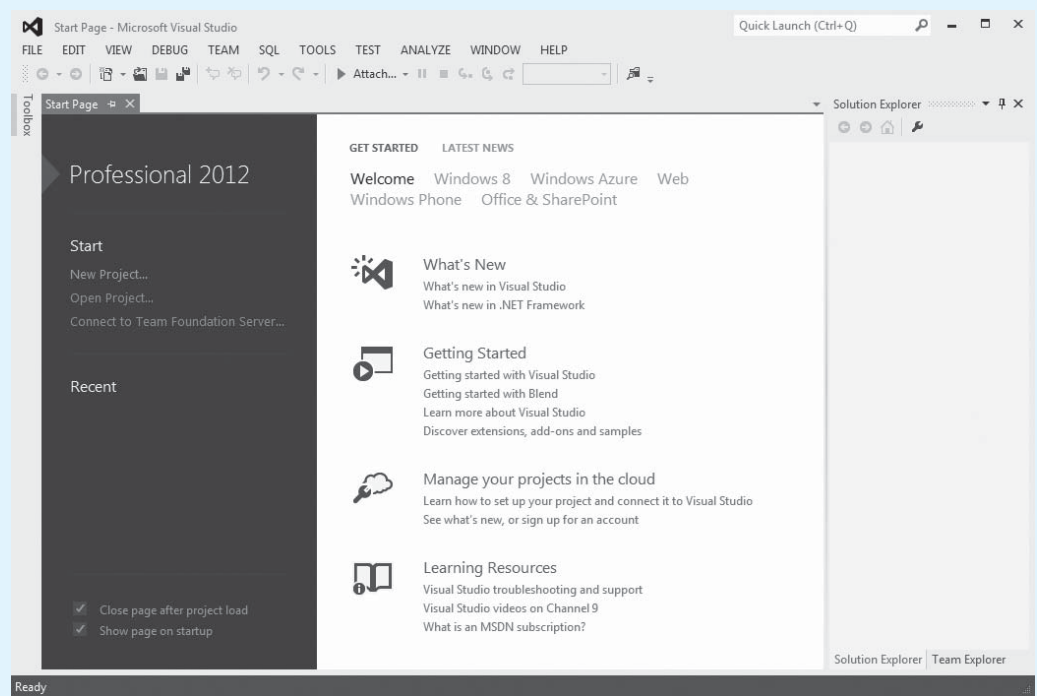
- If you are using Visual Studio, open the Microsoft Visual Studio 2012 program group and then execute Visual Studio 2012.
- If you are using Visual Studio 2012 Express for Windows Desktop, open the Microsoft Visual Studio 2012 Express program group and then execute VS Express for Desktop.



**NOTE:** The first time you run Visual Studio, you will see a window entitled *Choose Default Environment Settings*. Select *Visual C# Development Settings* from the list and click the *Start Visual Studio* button.

**Step 2:** Figure 1-29 shows the Visual Studio environment. The screen shown in the figure is known as the *Start Page*. By default, the *Start Page* is displayed when you start Visual Studio, but you may not see it because it can be disabled.

Notice the check box in the bottom left corner of the *Start Page* that reads *Show page on startup*. If this box is not checked, the *Start Page* will not be displayed when you start Visual Studio. If you do not see the *Start Page*, you can always display it by clicking *VIEW* on the menu bar at the top of the screen and then clicking *Start Page*.

**Figure 1-29** Visual Studio Start Page

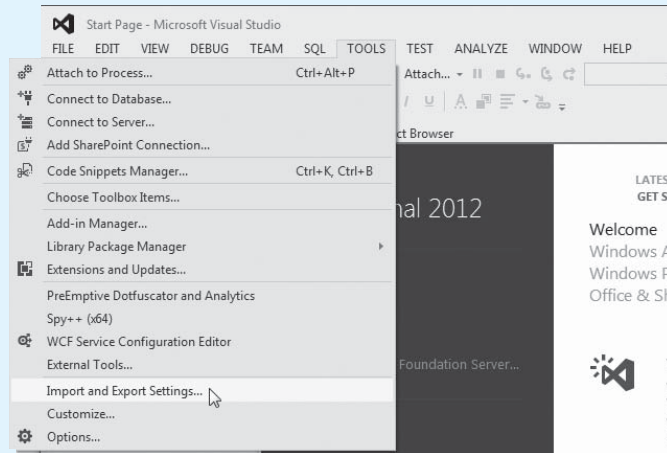
**Step 3:** In a school computer lab, it is possible that the Visual Studio environment has been set up for a programming language other than Visual C#. To make sure that Visual Studio looks and behaves as described in this book, you should make sure that Visual C# is selected as the programming environment. Perform the following:

- As shown in Figure 1-30, click *TOOLS* on the menu bar and then click *Import and Export Settings...*
- On the screen that appears next, select *Reset all settings* and click the *Next >* button.
- On the screen that appears next, select *No, just reset settings, overwriting my current settings*. If you are using Visual Studio Express, click the *Finish* button at this point, and proceed to Step 4 of the tutorial. If you are using Visual Studio, click the *Next >* button.
- If you are using Visual Studio, the window shown in Figure 1-31 should appear next. Select *Visual C# Development Settings* and then click the *Finish* button. After a moment you should see a *Reset Complete* window. Click the *Close* button and continue with the next step in the tutorial.

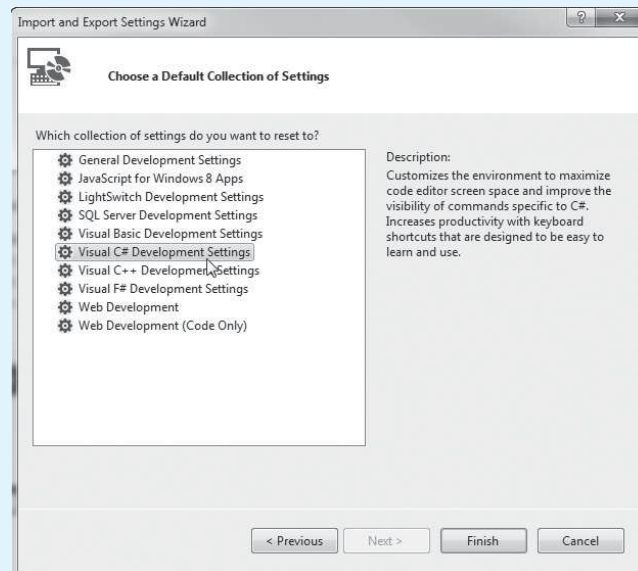
**Step 4:** Now you will reset Visual Studio's window layout to the default configuration. As shown in Figure 1-32, click *WINDOW* on the menu bar and then click *Reset Window Layout*. Next you will see a dialog box asking *Are you sure you want to restore the default window layout for the environment?* Click *Yes*.

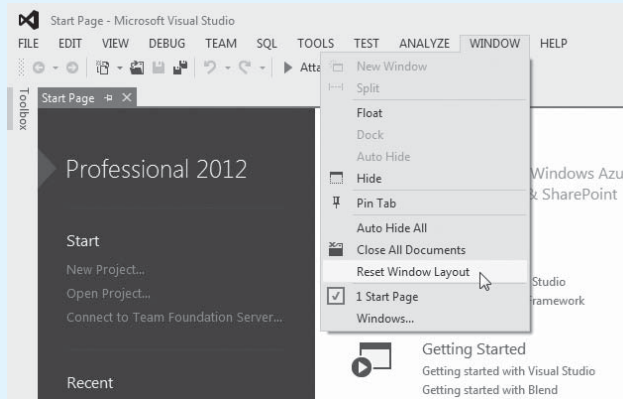
The Visual Studio environment is now set up so you can follow the remaining tutorials in this book. If you are working in your school’s computer lab, it is probably a good idea to go through these steps each time you start Visual Studio. If you are continuing with the next tutorial, leave Visual Studio running. You can exit Visual Studio at any time by clicking *FILE* on the menu bar and then clicking *Exit*.

**Figure 1-30** Selecting *Tools* and then *Import and Export Settings ...*



**Figure 1-31** Selecting *Visual C# Development Settings*



**Figure 1-32** Resetting the window layout

## Starting a New Project

Each Visual C# application that you create is called a **project**. When you are ready to create a new application, you start a new project. Tutorial 1-2 leads you through the steps of starting a new Visual C# project.



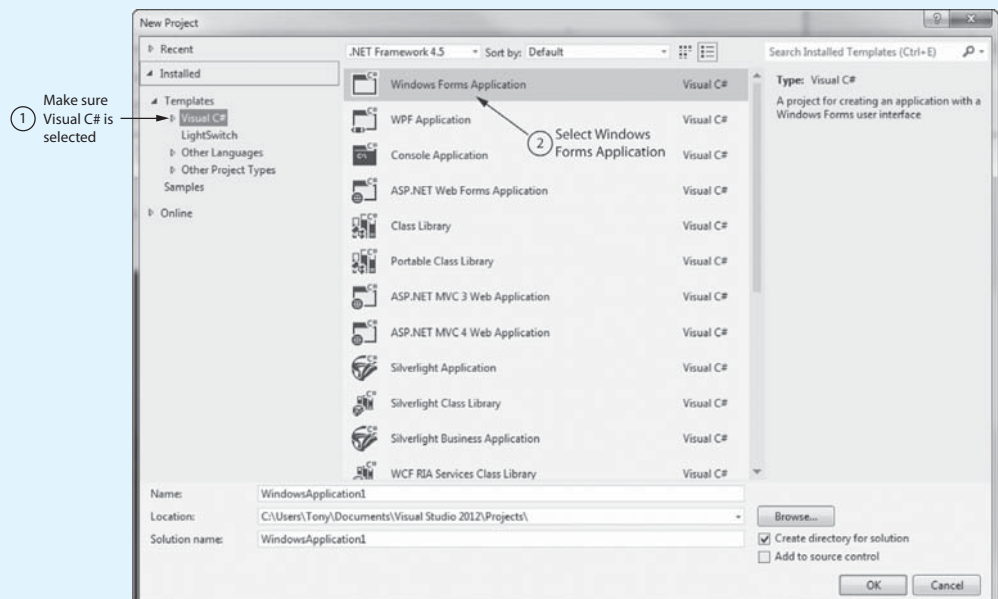
### Tutorial 1-2: Starting a New Visual C# Project



VideoNote  
**Tutorial 1-2:**  
Starting a  
New Visual  
C# Project

**Step 1:** If Visual Studio is not already running, start it as you did in Tutorial 1-1.

**Step 2:** If you are using Visual Studio 2012: Click *FILE* on the menu bar at the top of the screen, then select *New*, and then select *Project*. After doing this, the *New Project* window shown in Figure 1-33 should be displayed.

**Figure 1-33** The *New Project* window

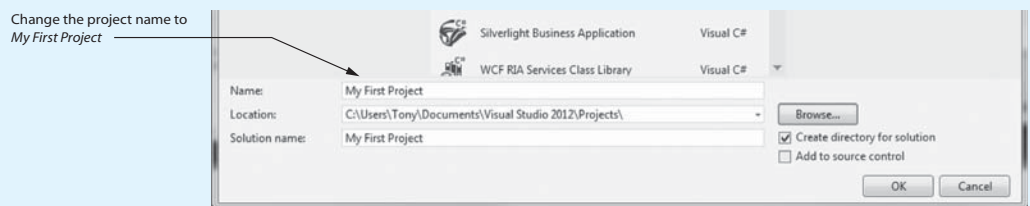


**If you are using Visual Studio 2012 Express:** Click *FILE* on the menu bar at the top of the screen and then select *New Project*. After doing this, a *New Project* window similar to Figure 1-33 should be displayed. (With Visual Studio Express, the window will have fewer items than shown in the figure.)

**Step 3:** At the left side of the window, under *Installed Templates*, make sure *Visual C#* is selected. Then, select *Windows Forms Application*, as shown in Figure 1-33.

**Step 4:** At the bottom of the *New Project* window, you see a *Name* text box. This is where you enter the name of your project. The *Name* text box will be automatically filled in with a default name. In Figure 1-33 the default name is *WindowsApplication1*. Change the project name to *My First Project*, as shown in Figure 1-34.

**Figure 1-34** Changing the project name to *My First Project*



**If you are using Visual Studio 2012:** Just below the *Name* text box you will see a *Location* text box and a *Solution name* text box.

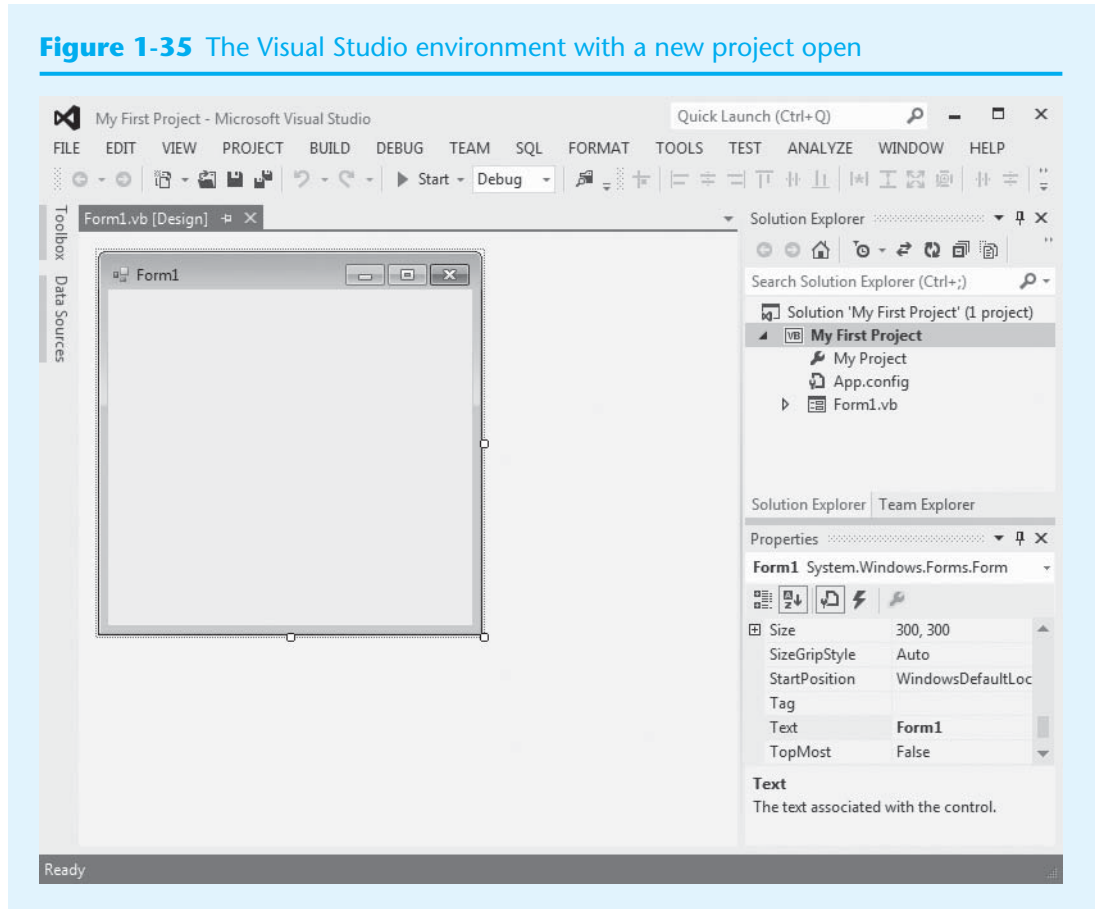
- The *Location* text box shows where a folder will be created to hold the project. If you wish to change the location, click the *Browse* button and select the desired location.
- A solution is a container that holds a project, and the *Solution name* text box shows the name of the solution that will hold this project. By default, the solution name is the same as the project name. For all the projects that you create in this book, you should keep the solution name the same as the project name.



**NOTE:** As you work through this book you will create a lot of Visual C# projects. As you do, you will find that default names such as *WindowsApplication1* do not help you remember what each project does. Therefore, you should always change the name of a new project to something that describes the project's purpose.

**Step 5:** Click the *OK* button to create the project. It might take a moment for the project to be created. Once it is, the Visual Studio environment should appear, similar to Figure 1-35. Notice that the name of the project, *My First Project*, is displayed in the title bar at the top of the Visual Studio window.

Leave Visual Studio running and complete the next tutorial.

**Figure 1-35** The Visual Studio environment with a new project open

### Tutorial 1-3: Saving and Closing a Project



VideoNote

**Tutorial 1-3:**  
Saving and  
Closing a  
Project

As you work on a project, you should get into the habit of saving it often. In this tutorial you will save the *My First Project* application and then close it.

**Step 1:** Visual Studio should still be running from the previous tutorial. To save the project that is currently open, click *FILE* on the menu bar and then select *Save All*.

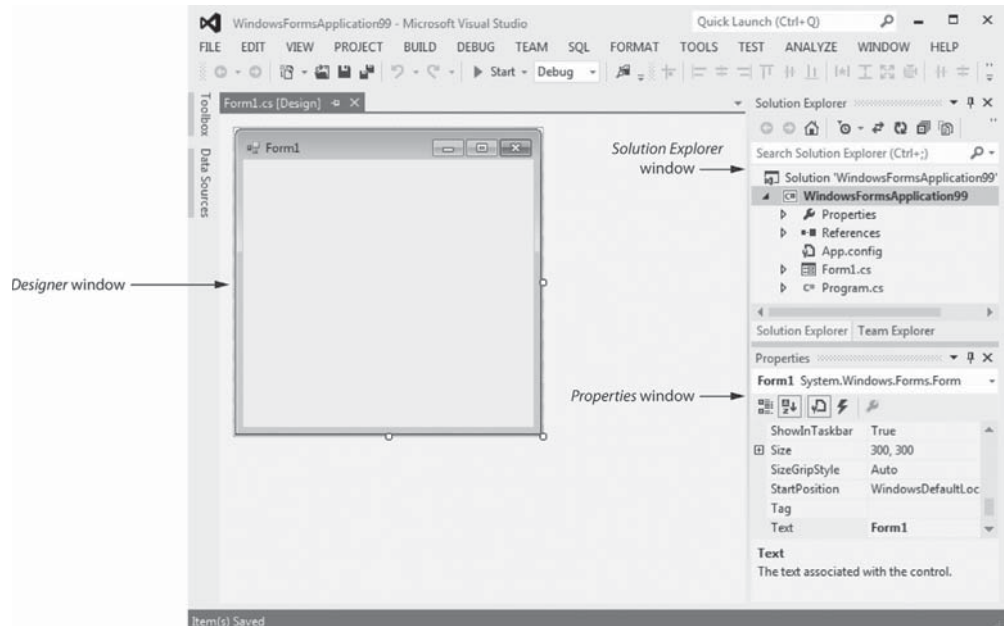
**Step 2:** To close the project, click *FILE* on the menu bar and then click *Close Solution*.

## The Visual Studio Environment

The Visual Studio environment consists of a number of windows that you will use on a regular basis. Figure 1-36 shows the locations of the following windows that appear within the Visual Studio environment: the *Designer* window, the *Solution Explorer* window, and the *Properties* window. Here is a brief summary of each window's purpose:

- **The *Designer* Window**

You use the *Designer* window to create an application's graphical user interface. The *Designer* window shows the application's form and allows you to visually

**Figure 1-36** The *Designer* window, *Solution Explorer* window, and *Properties* window

design its appearance by placing the desired controls that will appear on the form when the application executes.

- **The *Solution Explorer* Window**

A solution is a container for holding Visual C# projects. (We discuss solutions in greater detail in a moment.) When you create a new C# project, a new solution is automatically created to contain it. The *Solution Explorer* window allows you to navigate among the files in a Visual C# project.

- **The *Properties* Window**

A control's appearance and other characteristics are determined by the control's properties. When you are creating a Visual C# application, you use the *Properties* window to examine and change a control's properties.

Remember that Visual Studio is a customizable environment. You can move the various windows around, so they may not appear in the exact locations shown in Figure 1-36 on your system.

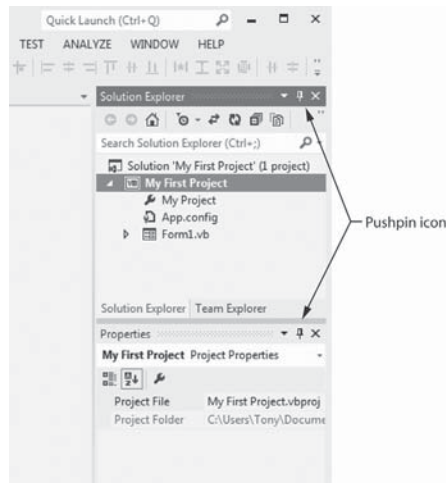
### Displaying the *Solution Explorer* and *Properties* Windows

If you do not see the *Solution Explorer* or the *Properties* window, you can follow these steps to make them visible:

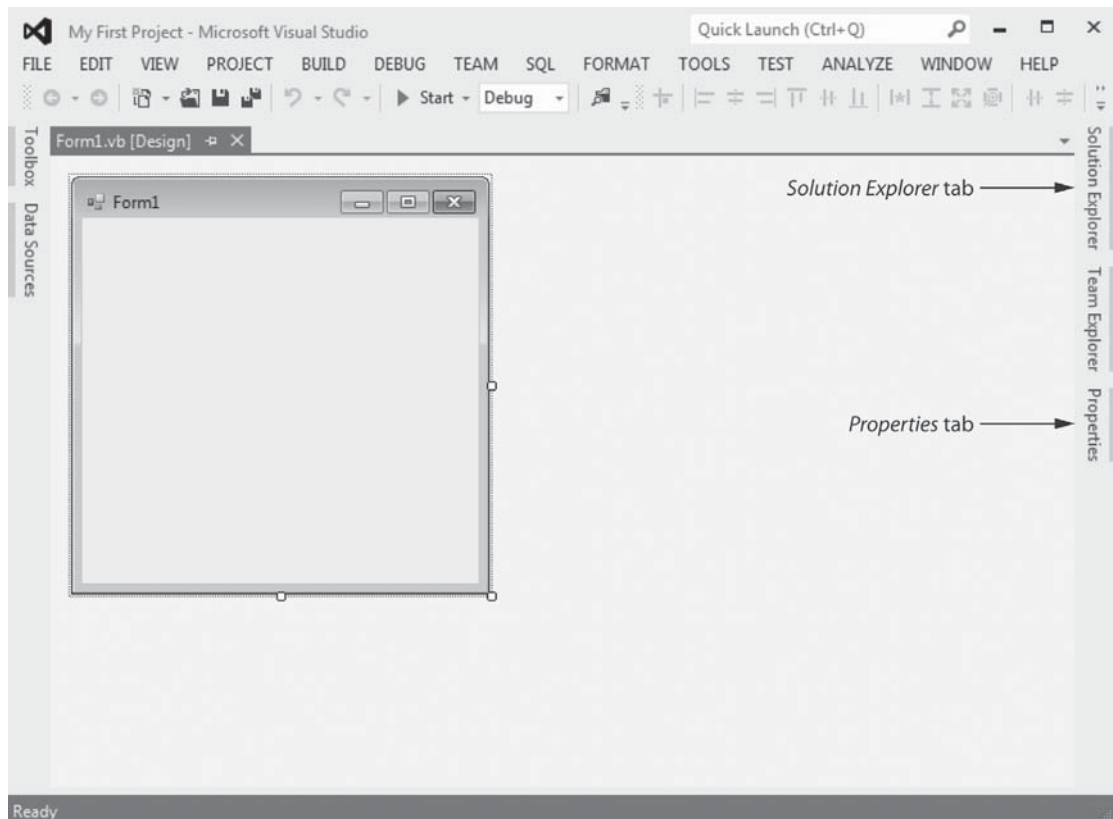
- If you do not see the *Solution Explorer* window, click *VIEW* on the menu bar. On the *View* menu, click *Solution Explorer*.
- If you do not see the *Properties* window, click *VIEW* on the menu bar. On the *View* menu, click *Properties*.

### Using Auto Hide

Many windows in Visual Studio have a feature known as **Auto Hide**. When you see the pushpin icon in a window's title bar, as shown in Figure 1-37, you know that the window has Auto Hide capability. You click the pushpin icon to turn Auto Hide on or off for a window.

**Figure 1-37** Auto Hide pushpin icon

When Auto Hide is turned on, the window is displayed only as a tab along one of the edges of the Visual Studio environment. This feature gives you more room to view your application's forms and code. Figure 1-38 shows how the *Solution Explorer* and *Properties* windows appear when their Auto Hide feature is turned on. Notice the tabs that read *Solution Explorer* and *Properties* along the right edge of the screen. (Figure 1-38 also shows a *Team Explorer* tab. You might see this tab if you are using Visual Studio 2012. We do not discuss the *Team Explorer* in this book.)

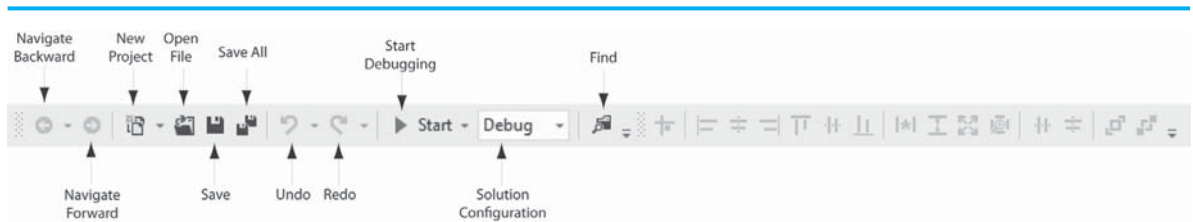
**Figure 1-38** The *Solution Explorer* and *Properties* windows hidden

## The Menu Bar and the Standard Toolbar

You've already used the Visual Studio menu bar several times. This is the bar at the top of the Visual Studio window that provides menus such as *FILE*, *EDIT*, *VIEW*, *PROJECT*, and so forth. As you progress through this book, you will become familiar with many of the menus.

Below the menu bar is the standard toolbar. The **standard toolbar** contains buttons that execute frequently used commands. All commands that are displayed on the toolbar may also be executed from a menu, but the standard toolbar gives you quicker access to them. Figure 1-39 identifies the standard toolbar buttons that you will use most often, and Table 1-3 gives a brief description of each.

**Figure 1-39** Visual Studio toolbar buttons



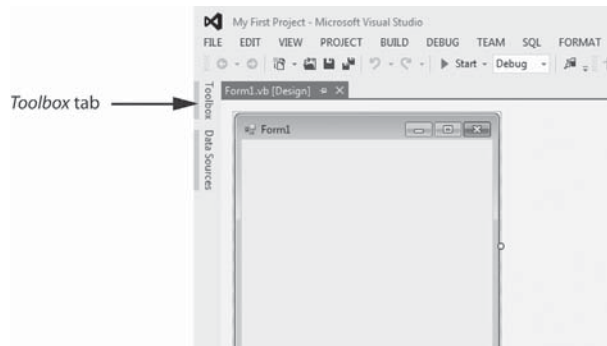
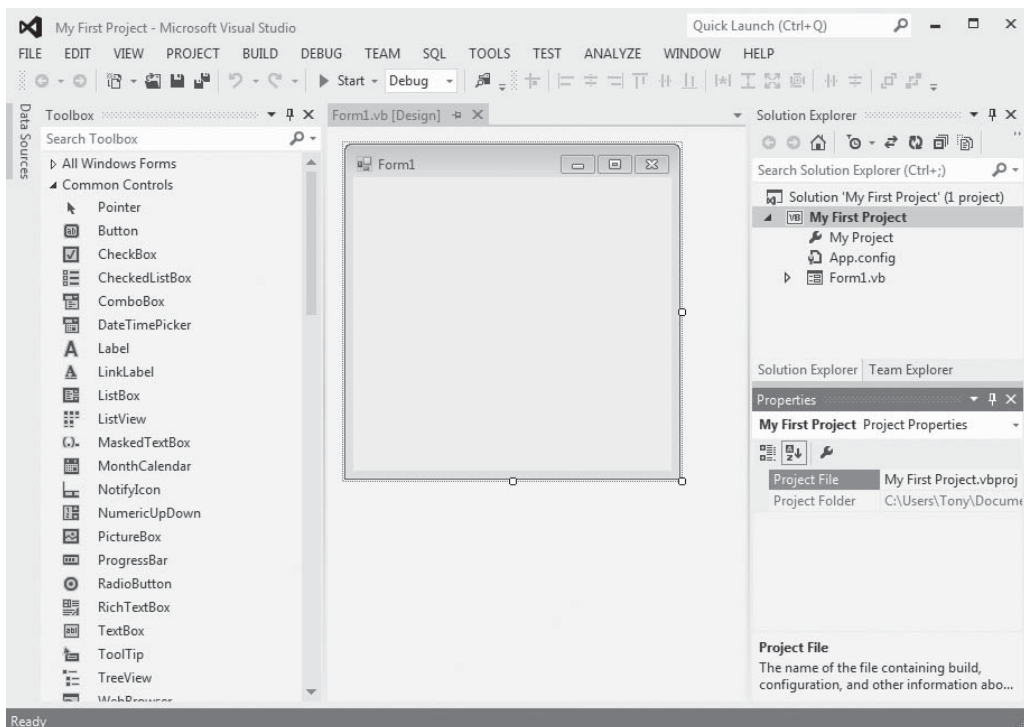
**Table 1-3** Visual Studio toolbar buttons

Toolbar Button	Description
Navigate Backward	Moves to the previously active tab in the <i>Designer</i> window
Navigate Forward	Moves to the next active tab in the <i>Designer</i> window
New Project	Starts a new project
Open File	Opens an existing file
Save	Saves the file named by <i>filename</i>
Save All	Saves all the files in the current project
Undo	Undoes the most recent operation
Redo	Redoes the most recently undone operation
Start Debugging	Starts debugging (running) your program
Solution Configurations	Configures your project's executable code
Find	Searches for text in your application code

## The Toolbox

The *Toolbox* is a window that allows you to select the controls that you want to use in an application's user interface. When you want to place a Button, Label, TextBox, or other control on an application's form, you select it in the *Toolbox*. You will use the *Toolbox* extensively as you develop Visual C# applications.

The *Toolbox* typically appears on the left side of the Visual Studio environment. If the *Toolbox* is in Auto Hide mode, its tab will appear as shown in Figure 1-40. Figure 1-41 shows the *Toolbox* opened, with Auto Hide turned off.

**Figure 1-40** The *Toolbox* tab (Auto Hide turned on)**Figure 1-41** The *Toolbox* opened (Auto Hide turned off)

**NOTE:** If you do not see the *Toolbox* or its tab along the side of the Visual Studio environment, click *VIEW* on the menu bar and then click *Toolbox*. (In Visual Studio Express, click *VIEW* on the menu bar, then click *Other Windows*, and then click *Toolbox*.)

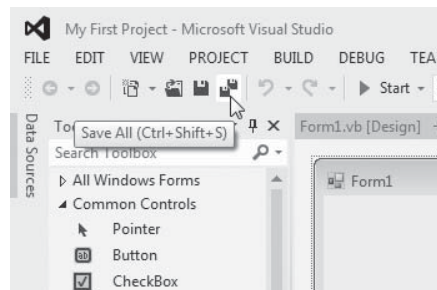
The *Toolbox* is divided into sections, and each section has a name. In Figure 1-41 you can see the *All Windows Forms* and *Common Controls* sections. If you scroll the *Toolbox*, you will see many other sections. Each section can be opened or closed.

If you want to open a section of the *Toolbox*, you simply click on its name tab. To close the section, click on its name tab again. In Figure 1-41, the *Common Controls* section is open. You use the *Common Controls* section to access controls that you frequently need, such as Buttons, Labels, and TextBoxes. You can move any section to the top of the list by dragging its name with the mouse.

## Using ToolTips

A **ToolTip** is a small rectangular box that pops up when you hover the mouse pointer over a button on the toolbar or in the *Toolbox* for a few seconds. The ToolTip box contains a short description of the button's purpose. Figure 1-42 shows the ToolTip that appears when the cursor is left sitting on the *Save All* button. Use a ToolTip whenever you cannot remember a particular button's function.

**Figure 1-42** *Save All* ToolTip



## Docked and Floating Windows

Figure 1-41 shows the *Toolbox*, *Solution Explorer*, and *Properties* windows when they are **docked**, which means they are attached to one of the edges of the Visual Studio window. Alternatively, the windows can be **floating**. You can control whether a window is docked or floating as follows:

- To change a window from docked to floating, right-click its title bar and select *Float*.
- To change a window from floating to docked, right-click its title bar and select *Dock*.

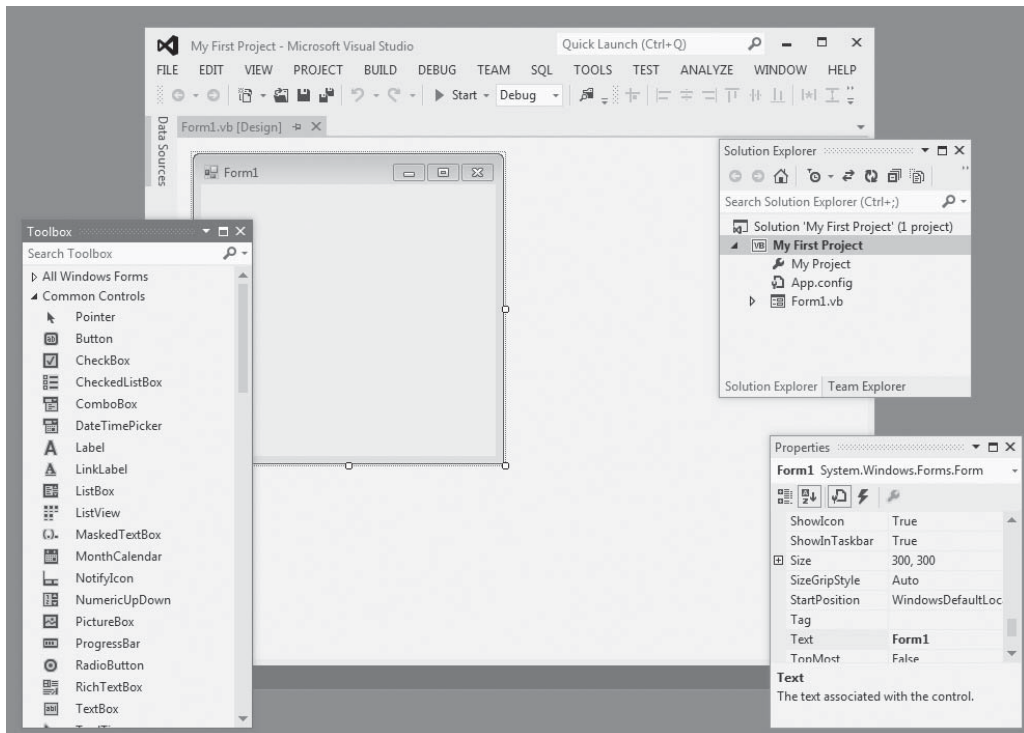
Figure 1-43 shows Visual Studio with the *Toolbox*, *Solution Explorer*, and *Properties* windows floating. When a window is floating, you can click and drag it by its title bar around the screen. You may use whichever style you prefer—docked or floating. When windows are floating, they behave as normal windows. You may move or resize them to suit your preference.



**NOTE:** A window cannot float if its Auto Hide feature is turned on.



**TIP:** Remember, you can always reset the window layout by clicking *WINDOW* on the menu bar and then selecting *Reset Window Layout*. If you accidentally close the *Designer* window, the *Solution Explorer* window, or the *Properties* window, you can use the *VIEW* menu to redisplay them.

**Figure 1-43** *Toolbox, Solution Explorer, and Properties windows floating*

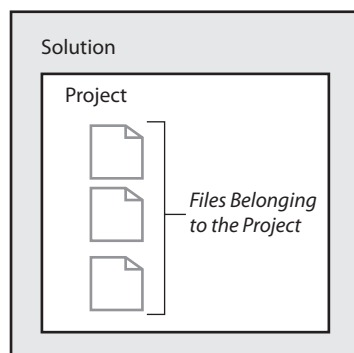
## Projects and Solutions

As you learn to program in Visual C#, you will see the terms *project* and *solution* used often. These terms do not mean the same thing, but they are sometimes used interchangeably. Let's briefly discuss the difference between a project and a solution.

Each Visual C# application that you create is called a project. A Visual C# project consists of several files. You can think of a project as a collection of files that belong to a single application.

A **solution** is a container that holds one or more Visual C# projects. If you are developing applications for a large organization, you might find it convenient to store several related projects together in the same solution.

Although it is possible for a solution to hold more than one project, each project that you will create in this book will be saved in its own solution. Each time you create a new project, you will also create a new solution to hold it. Figure 1-44 illustrates this concept. Typically, the solution will be given the same name as the project.

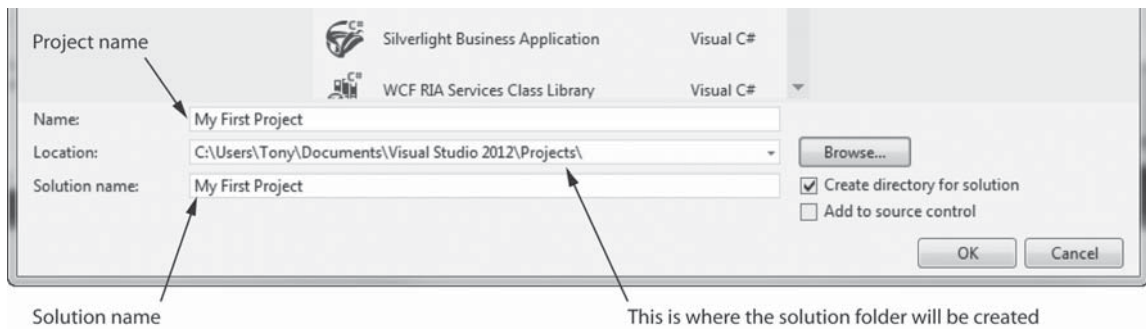
**Figure 1-44** *Solution and project organization*



## Typical Organization of Solutions and Projects on the Disk

When you create a new project, you specify the project’s name, the solution’s name, and a location on the disk where the solution should be stored. If you are using Visual Studio, you specify this information at the bottom of the *New Project* window, as shown in Figure 1-45. If you are using Visual Studio Express, you specify this information in the *Save Project* window the first time you save the project.

**Figure 1-45** Specifying the project name, solution name, and location

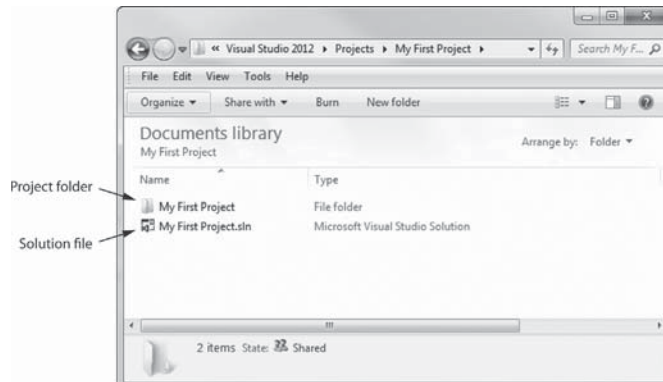


Let’s use Figure 1-45 to see an example of how the files for the *My First Project* solution and project will be organized on the disk. Notice that in Figure 1-45, the following location is shown for the solution:

`C:\Users\Tony\Documents\Visual Studio 2012\Projects\`

On your system, the location will not be exactly the same as this, but it will be something similar. At this location, a **solution folder** named *My First Project* will be created. If we use Windows to look inside that folder, we will see the two items shown in Figure 1-46. Notice that one of the items is another folder named *My First Project*. That is the **project folder**, which contains various files related to the project. The other item is the **solution file**. In Windows, you can double-click the solution file to open the project in Visual Studio.

**Figure 1-46** Contents of the *My First Project* solution folder



## Opening an Existing Project

If Visual Studio is already running, you can perform the following steps to open an existing project:

- Click *FILE* on the Visual Studio menu bar, then select *Open*, and then select *Project/Solution. . . .*
- The *Open Project* window will appear. Navigate to the desired solution folder, select the solution file, and click *Open*.

In Visual Studio Express, perform the following steps to open an existing project:

- Click *FILE* on the Visual Studio menu bar and then select *Open Project. . . .*
- The *Open Project* window will appear. Navigate to the desired solution folder, select the solution file, and click *Open*.



### Tutorial 1-4: Opening an Existing Project

In this tutorial you will reopen the *My First Project* application that you created in Tutorial 1-2.

**Step 1:** Visual Studio should still be running from the previous tutorial. Perform one of the following operations to reopen *My First Project*:

#### If you are using Visual Studio:

Click *FILE* on the menu bar; select *Open* and then select *Project/Solution....* The *Open Project* window will appear. Navigate to the *My First Project* solution, select the solution file, and click the *Open* button.

#### If you are using Visual Studio Express:

Click *FILE* on the menu bar, and then select *Open Project....* The *Open Project* window will appear. Navigate to the *My First Project* solution, select the solution file, and click the *Open* button.

After performing this step, *My First Project* should be opened. If you plan to complete the next tutorial, leave Visual Studio running with *My First Project* opened.



VideoNote

**Tutorial 1-4:**  
Opening  
an Existing  
Project

## Displaying the Designer (When It Does Not Automatically Appear)

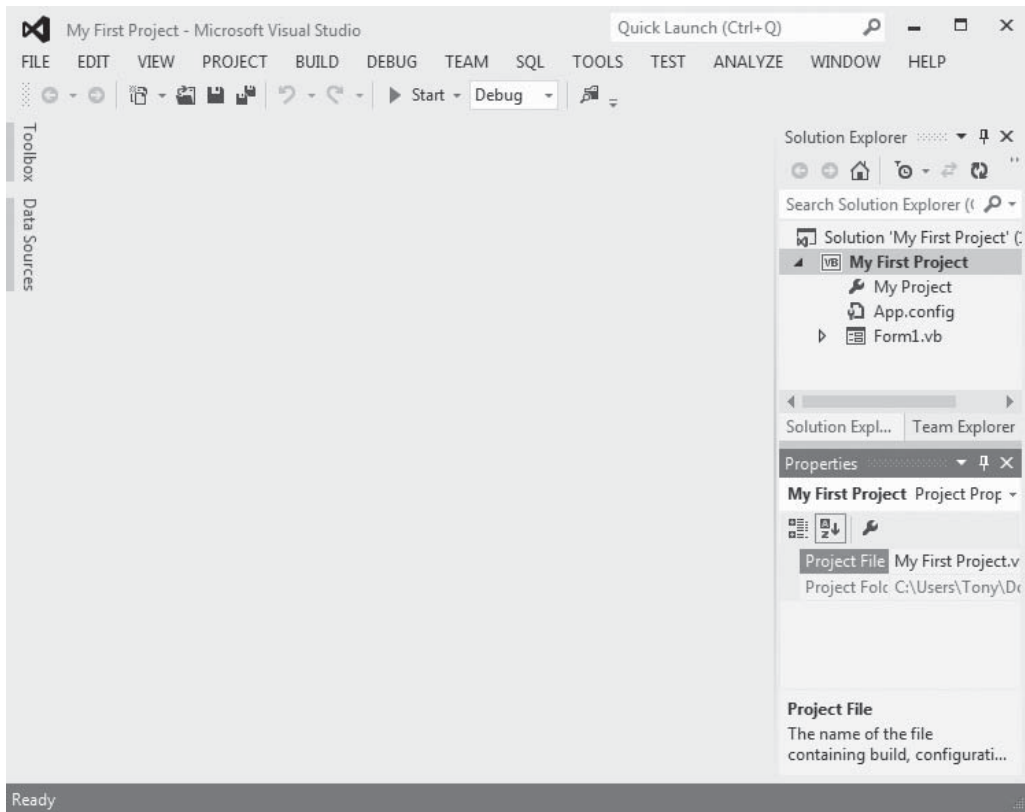
Sometimes when you open an existing project, the project's form will not be automatically displayed in the *Designer*. Figure 1-47 shows an example of the Visual Studio environment with an opened project but no form displayed in the *Designer*. When this happens, perform the following steps to display the project's form in the *Designer*:

- As shown in Figure 1-48, right-click *Form1.cs* in the *Solution Explorer*.
- Click *View Designer* in the pop-up menu.

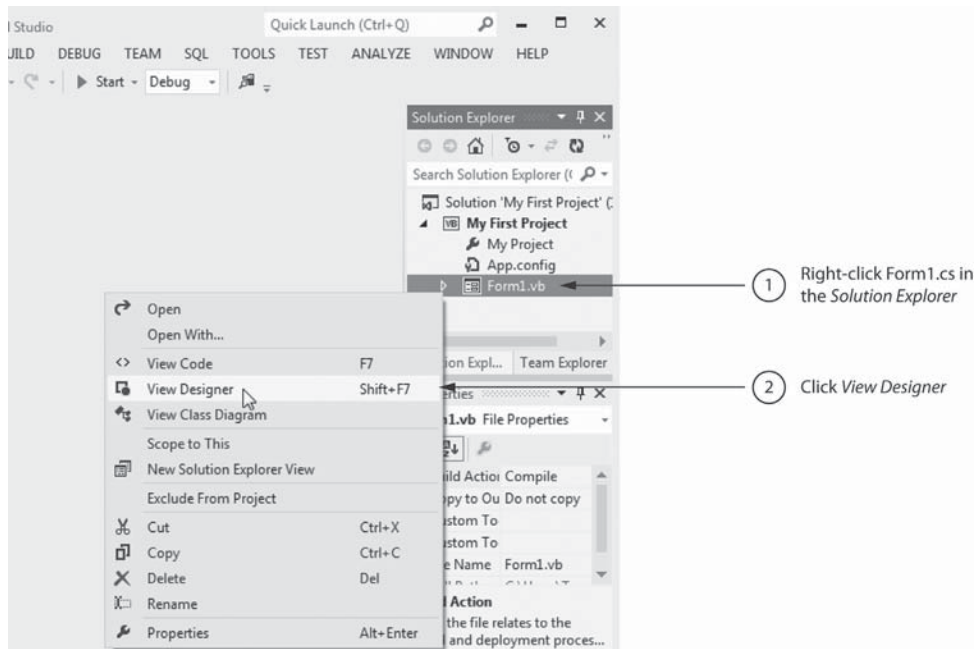
## Accessing the Visual Studio Documentation

You can access the documentation for Visual Studio by clicking *HELP* on the menu bar, and then selecting *View Help*. (Or, you can press **Ctrl+F1**, and then press **V** on the keyboard.) This launches your Web browser and opens the online *Microsoft Developer*

**Figure 1-47** A project opened with no form displayed in the *Designer*



**Figure 1-48** Using the *Solution Explorer* to open a form in the *Designer*



*Network (MSDN) Library*. The MSDN Library provides complete documentation for Visual C# as well as the other programming languages included in Visual Studio. You will also find code samples, tutorials, articles, and access to tutorial videos.



VideoNote

**Tutorial 1-5:**  
Getting  
Familiar  
with the  
Visual Studio  
Environment



## Tutorial 1-5:

### Getting Familiar with the Visual Studio Environment

This exercise will give you practice interacting with the *Solution Explorer* window, the *Properties* window, and the *Toolbox*.

- Step 1:** If Visual Studio is still running on your computer from the previous tutorial, continue to Step 2. If Visual Studio is not running on your computer, repeat the steps in Tutorial 1-4 to open *My First Project*.
- Step 2:** Practice turning the Auto Hide feature on and off for the *Solution Explorer* window, the *Properties* window, and the *Toolbox*. Recall from our previous discussion that clicking the pushpin icon in each window's title bar turns Auto Hide on and off. When you are finished practicing, make sure Auto Hide is turned off for each of these windows. Your screen should look like Figure 1-41.
- Step 3:** Practice floating and docking the *Solution Explorer* window, the *Properties* window, and the *Toolbox*. Recall from our previous discussion that you can make any of these windows float by right-clicking its title bar and selecting *Float*. You dock a floating window by right-clicking its title bar and selecting *Dock*.
- Step 4:** The *Toolbox*, *Solution Explorer*, and *Properties* windows each have a *Close* button (✕) in their upper-right corner. Close each of these windows by clicking its *Close* button.
- Step 5:** Do you remember which buttons on the toolbar restore the *Solution Explorer*, *Properties* window, and *Toolbox*? If not, move your mouse cursor over any button on the toolbar and leave it there until the ToolTip appears. Repeat this procedure on different buttons until you find the ones whose ToolTips read *Solution Explorer*, *Properties Window*, and *Toolbox*. (Refer to Figure 1-39 and Table 1-3 for further assistance.)
- Step 6:** Click the appropriate buttons on the toolbar to restore the *Solution Explorer*, the *Properties* window, and the *Toolbox*.
- Step 7:** Exit Visual Studio by clicking *FILE* on the menu bar and then clicking *Exit*. You may see a dialog box asking whether you wish to save changes to a number of items. Click *Yes*.



## Checkpoint

- 1.44 Briefly describe the purpose of the *Solution Explorer* window.
- 1.45 Briefly describe the purpose of the *Properties* window.
- 1.46 Briefly describe the purpose of the standard toolbar.
- 1.47 What is the difference between the toolbar and the *Toolbox*?
- 1.48 What is a ToolTip?
- 1.49 What is a project?
- 1.50 What is a solution?

## Key Terms

algorithm  
 American Standard Code for Information Interchange (ASCII)  
 application software  
 assembler  
 assembly language  
 Auto Hide  
 binary  
 binary digit  
 binary numbering system  
 bit  
 Button  
 byte  
 central processing unit (CPU)  
 class  
 code  
 command line interface  
 compact disc (CD)  
 compiler  
 console interface  
 controls  
 debug  
*Designer* window  
 digital  
 digital data  
 digital device  
 digital versatile disc (DVD)  
 disk drive  
 docked (window)  
 End terminal  
 ENIAC  
 event driven  
 executing  
 fetch-decode-execute cycle  
 fields  
 floating (window)  
 floating-point notation  
 floppy disk drive  
 flowchart  
 Form  
 graphical user interface (GUI)  
 hardware  
 high-level languages  
 input  
 input device  
 input symbols  
 instruction set  
 integrated development environment (IDE)  
 interpreter  
 keywords  
 Label  
 logic error  
 low-level language  
 machine language  
 main memory  
 methods  
 microprocessors  
 mnemonics  
 .NET Framework  
 object oriented  
 operating system  
 operators  
 output  
 output device  
 output symbols  
 picture element  
 pixel  
 processing symbols  
 program  
 program development cycle  
 programmer  
 project  
 project folder  
 properties  
*Properties* window  
 pseudocode  
 random-access memory (RAM)  
 reserved words  
 running  
 samples  
 secondary storage  
 software  
 software developer  
 software development tools  
 solution  
*Solution Explorer* window  
 solution file  
 solution folder  
 source code  
 standard toolbar  
 start terminal  
 statements  
 syntax  
 syntax error  
 system software  
 terminal symbol  
 TextBox  
*Toolbox*  
 ToolTip  
 two's complement  
 Unicode

universal serial bus (USB)  
user  
user interface  
utility program

volatile  
Visual Studio  
Visual Studio 2012  
Visual Studio 2012 Express

## Review Questions

### Multiple Choice

1. A(n) \_\_\_\_\_ is a set of instructions that a computer follows to perform a task.
  - a. compiler
  - b. program
  - c. interpreter
  - d. programming language
2. The physical devices that a computer is made of are referred to as \_\_\_\_\_.
  - a. hardware
  - b. software
  - c. the operating system
  - d. tools
3. The part of a computer that runs programs is called \_\_\_\_\_.
  - a. RAM
  - b. secondary storage
  - c. main memory
  - d. the CPU
4. Today, CPUs are small chips known as \_\_\_\_\_.
  - a. ENIACs
  - b. microprocessors
  - c. memory chips
  - d. operating systems
5. The computer stores a program while the program is running, as well as the data that the program is working with, in \_\_\_\_\_.
  - a. secondary storage
  - b. the CPU
  - c. main memory
  - d. the microprocessor
6. \_\_\_\_\_ is a volatile type of memory that is used only for temporary storage while a program is running.
  - a. RAM
  - b. secondary storage
  - c. the disk drive
  - d. the USB drive
7. A type of memory that can hold data for long periods of time—even when there is no power to the computer—is called \_\_\_\_\_.
  - a. RAM
  - b. main memory
  - c. secondary storage
  - d. CPU storage

8. A component that collects data from people or other devices and sends it to the computer is called \_\_\_\_\_.
  - a. an output device
  - b. an input device
  - c. a secondary storage device
  - d. main memory
9. A video display is a(n) \_\_\_\_\_ device.
  - a. output device
  - b. input device
  - c. secondary storage device
  - d. main memory
10. A \_\_\_\_\_ is enough memory to store a letter of the alphabet or a small number.
  - a. byte
  - b. bit
  - c. switch
  - d. transistor
11. A byte is made up of eight \_\_\_\_\_.
  - a. CPUs
  - b. instructions
  - c. variables
  - d. bits
12. In the \_\_\_\_\_ numbering system, all numeric values are written as sequences of 0s and 1s.
  - a. hexadecimal
  - b. binary
  - c. octal
  - d. decimal
13. A bit that is turned off represents the following value: \_\_\_\_\_.
  - a. 1
  - b. -1
  - c. 0
  - d. "no"
14. A set of 128 numeric codes that represent the English letters, various punctuation marks, and other characters is \_\_\_\_\_.
  - a. binary numbering
  - b. ASCII
  - c. Unicode
  - d. ENIAC
15. An extensive encoding scheme that can represent the characters of many of the languages in the world is \_\_\_\_\_.
  - a. binary numbering
  - b. ASCII
  - c. Unicode
  - d. ENIAC
16. Negative numbers are encoded using the \_\_\_\_\_ technique.
  - a. two's complement
  - b. floating point
  - c. ASCII
  - d. Unicode

17. Real numbers are encoded using the \_\_\_\_\_ technique.
  - a. two's complement
  - b. floating point
  - c. ASCII
  - d. Unicode
18. The tiny dots of color that digital images are composed of are called \_\_\_\_\_.
  - a. bits
  - b. bytes
  - c. color packets
  - d. pixels
19. If you were to look at a machine language program, you would see \_\_\_\_\_.
  - a. C# code
  - b. a stream of binary numbers
  - c. English words
  - d. circuits
20. In the \_\_\_\_\_ part of the fetch-decode-execute cycle, the CPU determines which operation it should perform.
  - a. fetch
  - b. decode
  - c. execute
  - d. immediately after the instruction is executed
21. Computers can execute only programs that are written in \_\_\_\_\_.
  - a. C#
  - b. assembly language
  - c. machine language
  - d. Java
22. The \_\_\_\_\_ translates an assembly language program to a machine language program.
  - a. assembler
  - b. compiler
  - c. translator
  - d. interpreter
23. The words that make up a high-level programming language are called \_\_\_\_\_.
  - a. binary instructions
  - b. mnemonics
  - c. commands
  - d. keywords
24. The rules that must be followed when writing a program are called \_\_\_\_\_.
  - a. syntax
  - b. punctuation
  - c. keywords
  - d. operators
25. A(n) \_\_\_\_\_ is a program that translates a high-level language program into a separate machine language program.
  - a. assembler
  - b. compiler
  - c. translator
  - d. utility



26. A \_\_\_\_\_ is any hypothetical person using a program and providing input for it.
- designer
  - user
  - guinea pig
  - test subject
27. A \_\_\_\_\_ error does not prevent the program from running but causes it to produce incorrect results.
- syntax
  - hardware
  - logic
  - fatal
28. A(n) \_\_\_\_\_ is a set of well-defined logical steps that must be taken to perform a task.
- logarithm
  - plan of action
  - logic schedule
  - algorithm
29. An informal language that has no syntax rules and is not meant to be compiled or executed is called \_\_\_\_\_.
- faux code
  - pseudocode
  - C#
  - a flowchart
30. A \_\_\_\_\_ is a diagram that graphically depicts the steps that take place in a program.
- flowchart
  - step chart
  - code graph
  - program graph
31. Objects that are visible in a program's graphical user interface are commonly referred to as \_\_\_\_\_.
- buttons
  - controls
  - forms
  - windows
32. A \_\_\_\_\_ is code that describes a particular type of object.
- namespace
  - blueprint
  - schema
  - class
33. The \_\_\_\_\_ is a collection of classes and other code that can be used, along with a programming language such as C#, to create programs for the Windows operating system.
- .NET framework
  - Standard Template Library
  - GUI framework
  - MSDN Library

34. The \_\_\_\_\_ is the part of a computer with which the user interacts.
  - a. central processing unit
  - b. user interface
  - c. control system
  - d. interactivity system
35. Before GUIs became popular, the \_\_\_\_\_ interface was the most commonly used.
  - a. command line
  - b. remote terminal
  - c. sensory
  - d. event-driven
36. \_\_\_\_\_ programs are usually event driven.
  - a. command line
  - b. text-based
  - c. GUI
  - d. procedural

### True or False

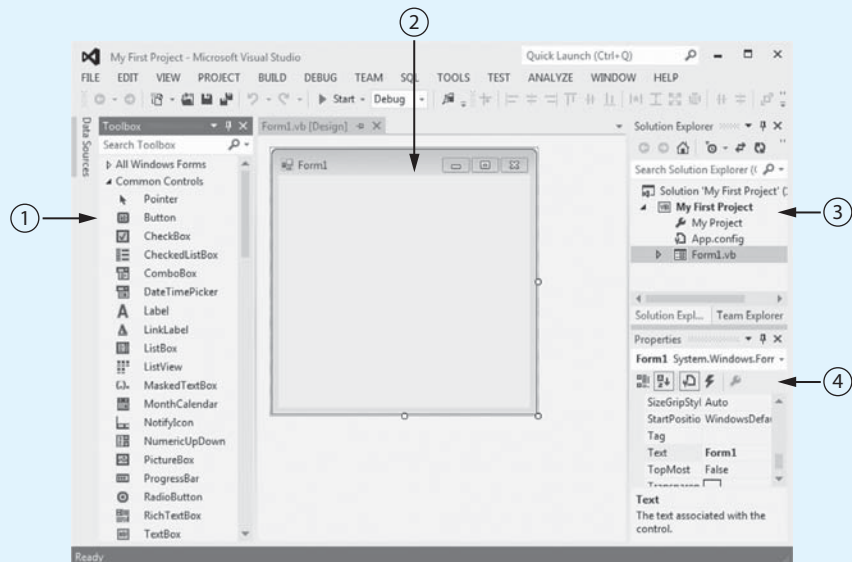
1. Today, CPUs are huge devices made of electrical and mechanical components such as vacuum tubes and switches.
2. Main memory is also known as RAM.
3. Any piece of data that is stored in a computer's memory must be stored as a binary number.
4. Images, such as the ones you make with your digital camera, cannot be stored as binary numbers.
5. Machine language is the only language that a CPU understands.
6. Assembly language is considered a high-level language.
7. An interpreter is a program that both translates and executes the instructions in a high-level language program.
8. A syntax error does not prevent a program from being compiled and executed.
9. Windows, Linux, UNIX, and Mac OS are all examples of application software.
10. Word processing programs, spreadsheet programs, e-mail programs, Web browsers, and games are all examples of utility programs.
11. Programmers must be careful not to make syntax errors when writing pseudocode programs.
12. C# provides only the basic keywords and operators that you need to construct a program.

### Short Answer

1. Why is the CPU the most important component in a computer?
2. What number does a bit that is turned on represent? What number does a bit that is turned off represent?
3. What would you call a device that works with binary data?
4. What are the words that make up a high-level programming language called?

5. What are the short words that are used in assembly language called?
6. What is the difference between a compiler and an interpreter?
7. What type of software controls the internal operations of the computer's hardware?
8. What is pseudocode? What is a flowchart?
9. When a program runs in a text-based environment, such as a command line interface, what determines the order in which things happen?
10. What does a class specify about an object?
11. Can you use C# alone to perform advanced operations such as creating GUIs, reading data from a file, or working with databases? Why or why not?
12. Figure 1-49 shows the Visual Studio IDE. What are the names of the four areas that are indicated in the figure?
13. What is the purpose of the *Toolbox* in the Visual Studio environment?
14. How can you access the documentation for Visual Studio? What resources are provided by the MSDN Library?
15. What steps must you take to open an existing project?
16. How can you view the project's form if it is not automatically displayed in the *Designer*?

**Figure 1-49** The Visual Studio IDE



## Programming Problems

1. Use what you've learned about the binary numbering system in this chapter to convert the following decimal numbers to binary:
  - 11
  - 65
  - 100
  - 255

2. Use what you've learned about the binary numbering system in this chapter to convert the following binary numbers to decimal:  
1101  
1000  
101011
3. Look at the ASCII chart in Appendix C and determine the codes for each letter of your first name.
4. Suppose your instructor gives three exams during the semester and you want to write a program that calculates your average exam score. Answer the following:
  - a. What items of input must the user enter?
  - b. Once the input has been entered, how will the program determine the average?
  - c. What output will the program display?

*This page intentionally left blank*

## TOPICS

- |     |   |      |   |
|-----|---|------|---|
| 2.1 | Getting Started with Forms and Controls   | 2.6  | Making Sense of IntelliSense                    |
| 2.2 | Creating the GUI for Your First Visual C# Application: The <i>Hello World</i> Application | 2.7  | PictureBox Controls                             |
| 2.3 | Introduction to C# Code   | 2.8  | Comments, Blank Lines, and Indentation          |
| 2.4 | Writing Code for the <i>Hello World</i> Application                                       | 2.9  | Writing the Code to Close an Application's Form |
| 2.5 | Label Controls  | 2.10 | Dealing with Syntax Errors                      |

## 2.1

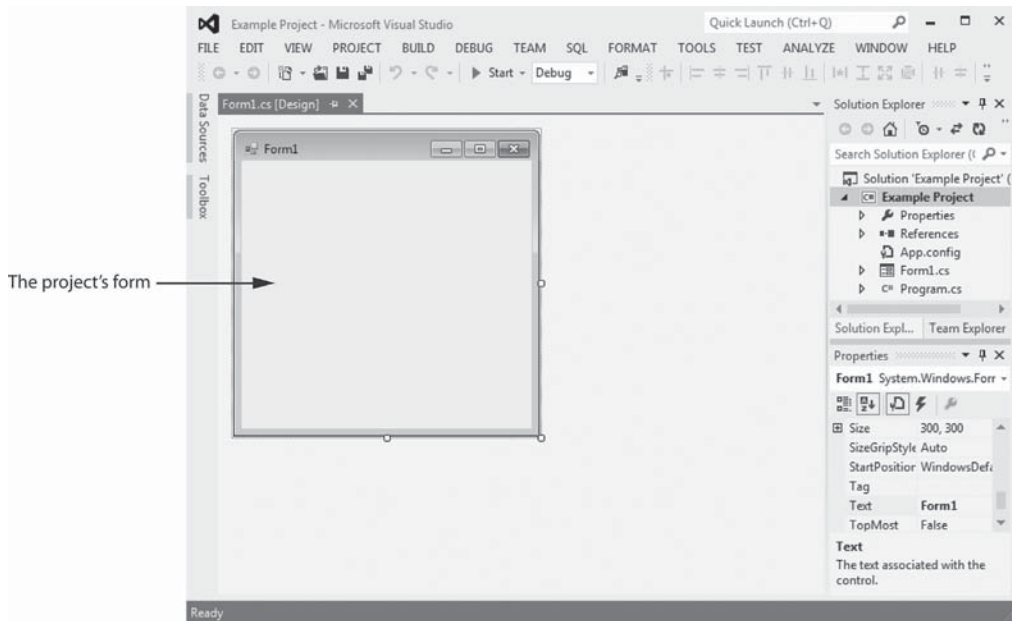
## Getting Started with Forms and Controls

**CONCEPT:** The first step in creating a Visual C# application is creating the application's GUI. You use the *Visual Studio Designer*, *Toolbox*, and *Properties* window to build the application's form with the desired controls and set each control's properties.

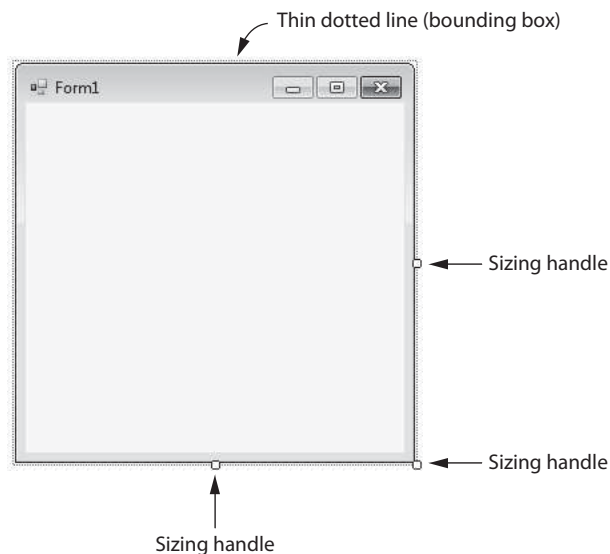
In this chapter you will create your first Visual C# application. Before you start, however, you need to learn some fundamental concepts about creating a GUI in Visual Studio. This section shows the basics of editing forms and creating controls.

### The Application's Form

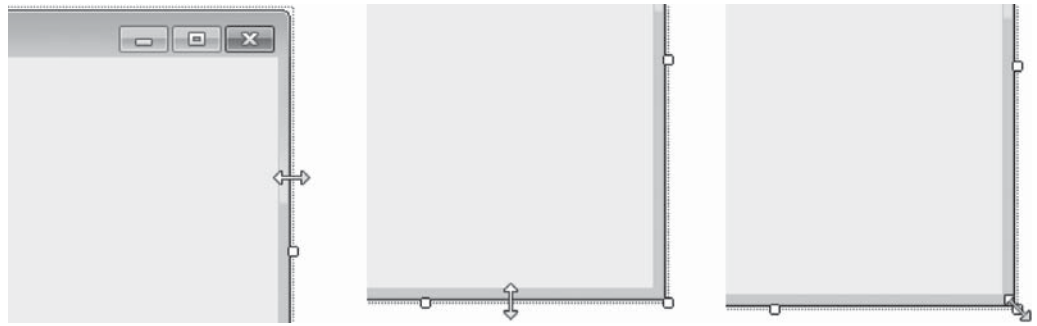
When you start a new Visual C# project, Visual Studio automatically creates an empty form and displays it in the *Designer*. Figure 2-1 shows an example. Think of the empty form as a blank canvas that can be used to create the application's user interface. You can add controls to the form, change the form's size, and modify many of its characteristics. When the application runs, the form will be displayed on the screen.

**Figure 2-1** A new project with a blank form displayed in the *Designer*

If you take a closer look at the form, you will notice that it is enclosed by a thin dotted line, known as a **bounding box**. As shown in Figure 2-2, the bounding box has small **sizing handles**, which appear on the form's right edge, bottom edge, and lower-right corner. When a bounding box appears around an object in the *Designer*, it indicates that the object is selected and is ready for editing.

**Figure 2-2** The form's bounding box and sizing handles

Initially the form's size is 300 pixels wide by 300 pixels high. You can easily resize the form with the mouse. When you position the mouse cursor over any edge or corner that has a sizing handle, the cursor changes to a two-headed arrow ( $\leftrightarrow$ ). Figure 2-3 shows examples. When the mouse cursor becomes a two-headed arrow, you can click and drag the mouse to resize form.

**Figure 2-3** Using the mouse to resize the form

## Identifying Forms and Controls by Their Names

An application's GUI is made of forms and various controls. Each form and control in an application's GUI must have a name that identifies it. The blank form that Visual Studio initially creates in a new project is named `Form1`.



**NOTE:** Later in this book you will learn how to change a form's name, but for now, you will keep the default name, `Form1`.

## The *Properties* Window

The appearance and other characteristics of a GUI object are determined by the object's properties. When you select an object in the *Designer*, that object's properties are displayed in the *Properties* window. For example, when the `Form1` form is selected, its properties are displayed in the *Properties* window, as shown in Figure 2-4.



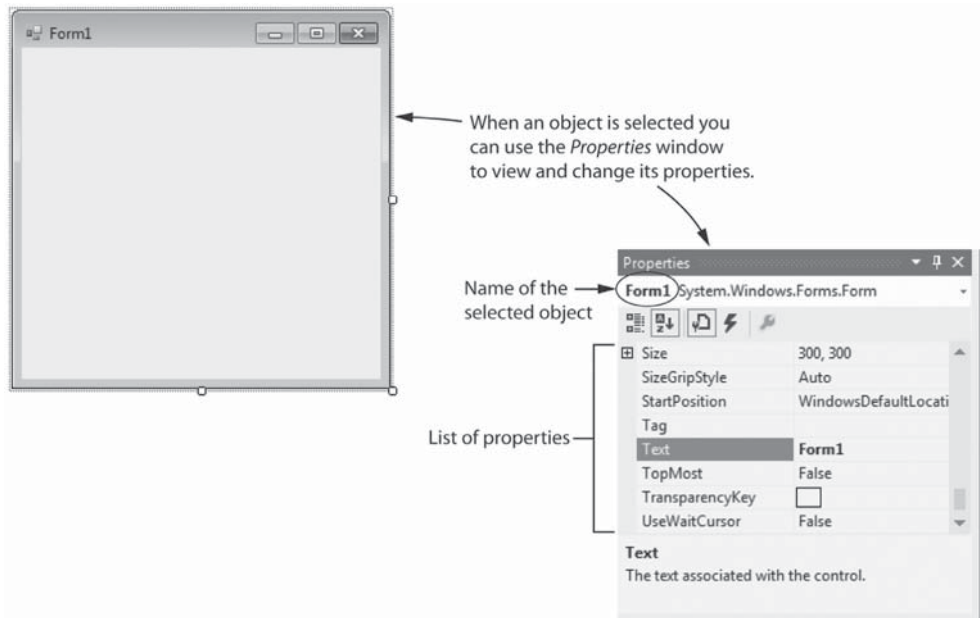
**TIP:** Recall from Chapter 1 that if the *Properties* window is in Auto Hide mode, you can click its tab to open it. If you do not see the *Properties* window, click *VIEW* on the menu bar. On the *VIEW* menu, click *Properties*. (In Visual Studio Express, click *VIEW, Other Windows, Properties*.)

The area at the top of the *Properties* window shows the name of the object that is currently selected. You can see in Figure 2-4 that the name of the selected object is `Form1`. Below that is a scrollable list of properties. The list of properties has two columns: The left column shows each property's name, and the right column shows each property's value. For example, look at the form's `Size` property in Figure 2-4. Its value is `300, 300`. This means that the form's size is 300 pixels wide by 300 pixels high. Next, look at the form's `Text` property. The `Text` property determines the text that is displayed in the form's title bar (the bar that appears at the top of the form). Its current value is `Form1`, so the text `Form1` is displayed in the form's title bar.

When a form is created, its `Text` property is initially set to the same value as the form's name. When you start a new project, the blank form that appears in the *Designer* will always be named `Form1`, so the text `Form1` will always appear in the form's title bar. In most cases you want to change the value of the form's `Text` property to something more meaningful. For example, assume the `Form1` form is currently selected. You can perform the following steps to change its `Text` property to `My First Program`.



**Figure 2-4** The *Properties* window, showing the selected object's properties



**Step 1:** In the *Properties* window, locate the *Text* property.

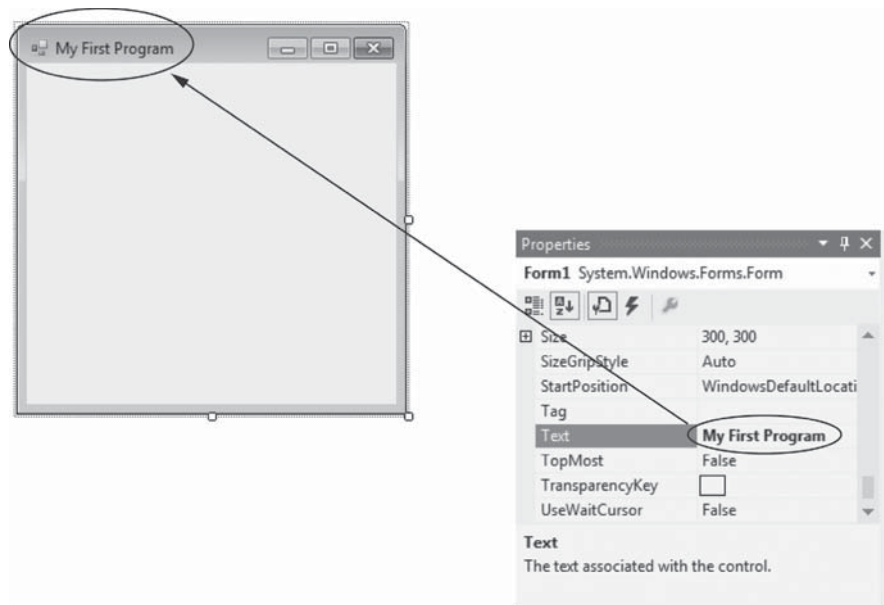
**Step 2:** Double-click the word *Form1* that currently appears as the *Text* property's value, and then use the **[Delete]** key to delete it.

**Step 3:** Type *My First Program* in its place and press the **[Enter]** key. The text *My First Program* will now appear in the form's title bar, as shown in Figure 2-5.



**NOTE:** Changing an object's *Text* property does not change the object's name. For example, if you change the *Form1* form's *Text* property to *My First Program*, the form's name is still *Form1*. You have changed only the text that is displayed in the form's title bar.

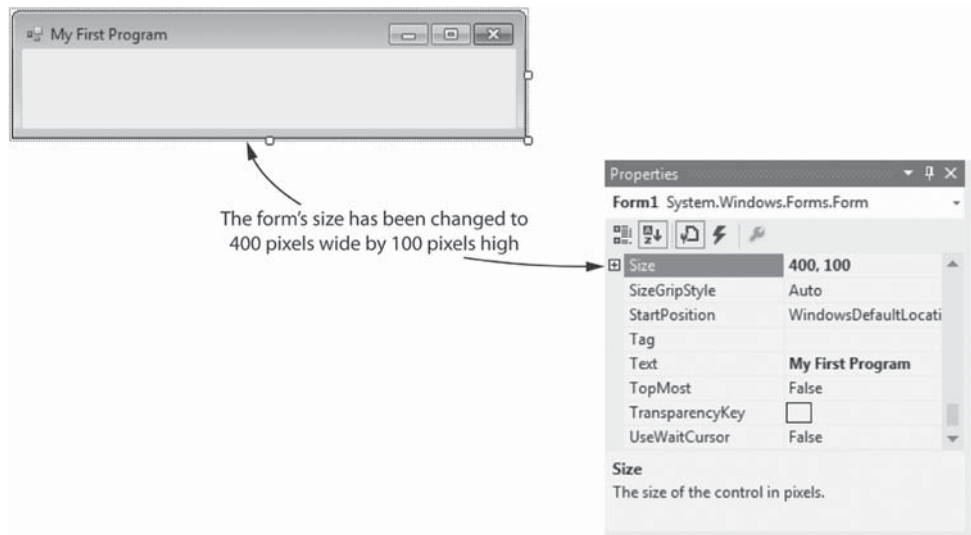
**Figure 2-5** The form's *Text* property value displayed in the form's title bar



Earlier we discussed how to use the mouse to resize a form in the *Designer*. An alternative method is to change the form's *Size* property in the *Properties* window. For example, assume the *Form1* form is currently selected. You can perform the following steps to change its size to 400 pixels wide by 100 pixels high.

- Step 1:** In the *Properties* window, locate the *Size* property.
- Step 2:** Click inside the area that holds the *Size* property's value, and then delete the current value.
- Step 3:** Type *400, 100* in its place and press the **Enter** key. The form will be resized as shown in Figure 2-6.

**Figure 2-6** The form's size changed to 400 by 100



**NOTE:** Notice in Figure 2-6 that the **Alphabetical button** (🔍) is selected near the top of the *Properties* window. This causes the properties to be displayed in alphabetical order. Alternatively, the **Categorized button** (📁) can be selected, which causes the properties to be displayed in groups. The alphabetical listing is the default selection, and most of the time, it makes it is easier to locate specific properties.

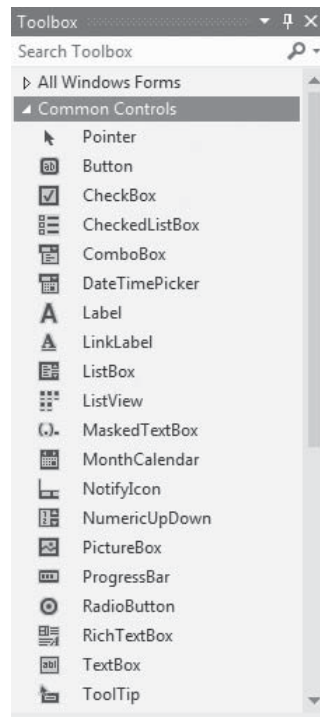
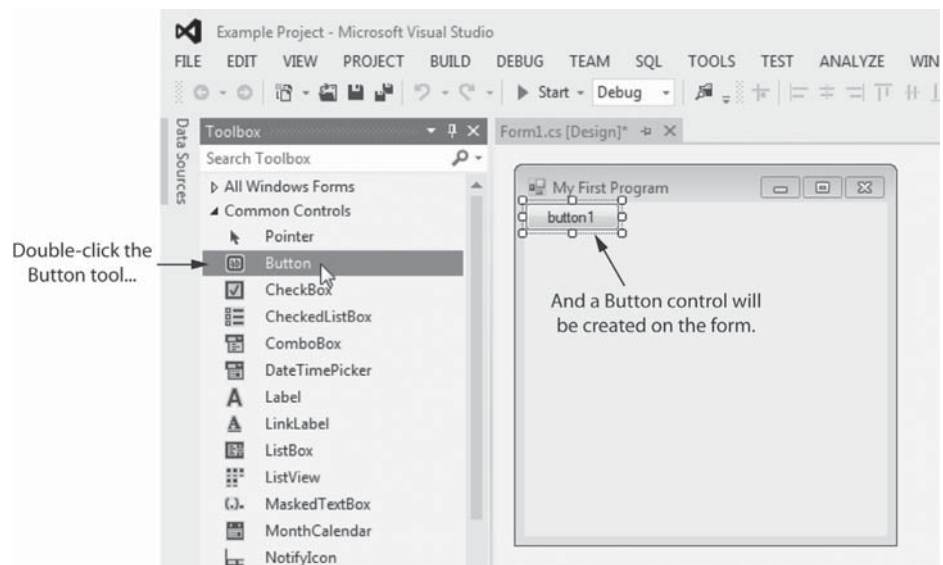
## Adding Controls to a Form

When you are ready to create controls on the application's form, you use the *Toolbox*. Recall from Chapter 1 that the *Toolbox* usually appears on the left side of the Visual Studio environment. If the *Toolbox* is in Auto Hide mode, you can click its tab to open it. Figure 2-7 shows an example of how the *Toolbox* typically appears when it is open.



**TIP:** Recall from Chapter 1 that if you do not see the *Toolbox* or its tab, click **VIEW** on the menu bar and then click *Toolbox*.

The *Toolbox* shows a scrollable list of controls that you can add to a form. To add a control to a form, you simply find it in the *Toolbox* and then double-click it. The control will be created on the form. For example, suppose you want to create a *Button* control on the form. You find it in the *Toolbox*, as shown in Figure 2-8, double-click it, and a *Button* control will appear on the form.

**Figure 2-7** The *Toolbox***Figure 2-8** Creating a Button control

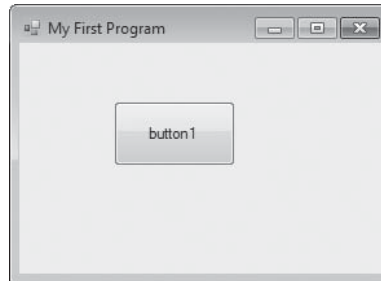
**TIP:** You can also click and drag controls from the *Toolbox* onto the form.

### Resizing and Moving Controls

Take a closer look at the Button control that is shown on the form in Figure 2-8. Notice that it is enclosed in a bounding box with sizing handles. This indicates that the control is currently selected. When a control is selected, you can use the mouse to resize it in the same way that you learned to resize a form earlier. You can also use the mouse to move a control to a

new location on the form. Position the mouse cursor inside the control, and when the mouse cursor becomes a four-headed arrow (☒), you can click and drag the control to a new location. Figure 2-9 shows a form with a Button control that has been enlarged and moved.

**Figure 2-9** A Button control resized and moved



### Deleting a Control

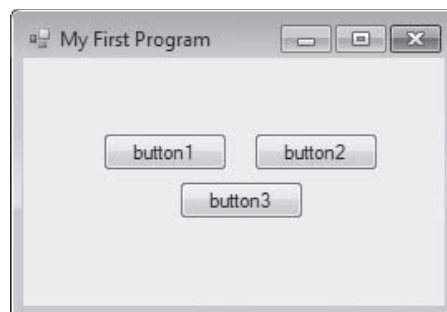
Deleting a control is simple: you select it and then press the `[Delete]` key on the keyboard.

### More about Button Controls

You learned earlier that each form and each control in an application's GUI must have a name that identifies it. When you create Button controls, they are automatically given default names such as `button1`, `button2`, and so forth.

Button controls have a `Text` property, which holds the text that is displayed on the face of the button. When a Button control is created, its `Text` property is initially set to the same value as the Button control's name. As a result, when you create a Button control, its name will be displayed on the face of the button. For example, the form in Figure 2-10 contains three Button controls named `button1`, `button2`, and `button3`.

**Figure 2-10** A form with three Button controls

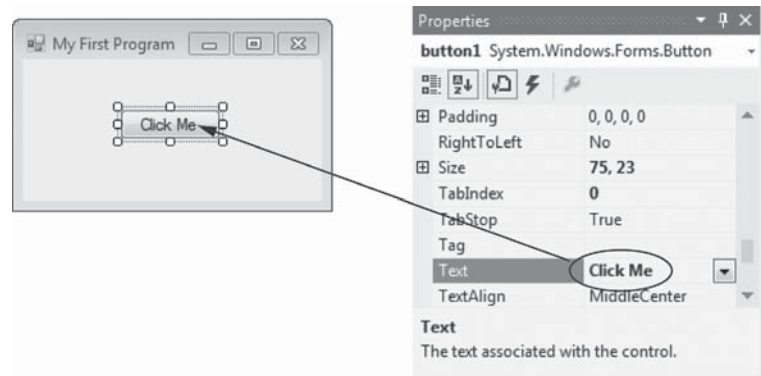


After you create a Button control, you should always change its `Text` property. The text that is displayed on a button should indicate what the button will do when it is clicked. For example, a button that calculates an average might have the text *Calculate Average* displayed on it, and a button that prints a report might have the text *Print Report* displayed on it. Here are the steps you perform to change a Button control's `Text` property:

- Step 1:** Make sure the Button control is selected. (If you don't see the bounding box and sizing handles around the control, just click the control to select it.)
- Step 2:** In the *Properties* window, locate the `Text` property.
- Step 3:** Click inside the area that holds the `Text` property's value, and then delete the current value. Then, type the new text in its place and press the `[Enter]` key. The new text will be displayed on the button.

Figure 2-11 shows an example of how changing a Button control's Text property changes the text displayed on the face of the button.

**Figure 2-11** A Button control's Text property changed



## Changing a Control's Name

A control's name identifies the control in the application's code and in the Visual Studio environment. When you create a control on an application's form, you should always change the control's name to something that is more meaningful than the default name that Visual Studio gives it. A control's name should reflect the purpose of the control.

For example, suppose you've created a Button control to calculate an amount of tax. A default name such as `button1` does not convey the button's purpose. A name such as `calculateTaxButton` would be much better. When you are working with the application's code and you see the name `calculateTaxButton`, you will know precisely which button the code is referring to.

You can change a control's name by changing its Name property. Here are the steps:

- Step 1:** Make sure the control is selected. (If you do not see the bounding box and sizing handles around the control, just click the control to select it.)
- Step 2:** In the *Properties* window, scroll up to the top of the list of properties. You should see the Name property, as shown in Figure 2-12. (The Name property is enclosed in parentheses to make it appear near the top of the alphabetical list of properties. This makes it easier to find.)
- Step 3:** Click inside the area that holds the Name property's value and then delete the current name. Then, type the new name in its place and press the **Enter** key. You have successfully changed the name of the control.

**Figure 2-12** The Name property

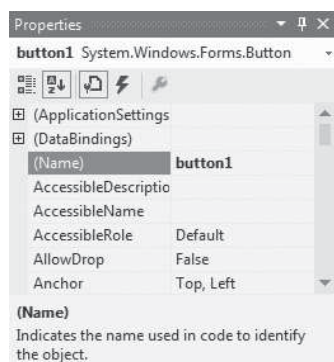
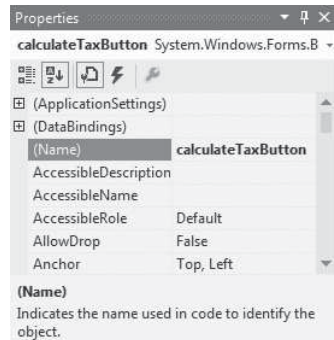


Figure 2-13 shows the *Properties* window after a Button control's name has been changed to `calculateTaxButton`.

**Figure 2-13** The Name property changed to `calculateTaxButton`



## Rules for Naming Controls

Control names are also known as **identifiers**. When naming a control, you must follow these rules for C# identifiers:

- The first character must be one of the letters *a* through *z* or *A* through *Z* or an underscore character (`_`).
- After the first character, you may use the letters *a* through *z* or *A* through *Z*, the digits 0 through 9, or underscores.
- The name cannot contain spaces.

Table 2-1 lists some identifiers that might be used for Button control names and indicates whether each is a legal or illegal identifier in C#.

**Table 2-1** Legal and illegal identifiers

Identifier	Legal or Illegal?
<code>showDayOfWeekButton</code>	Legal
<code>3rdQuarterButton</code>	Illegal because identifiers cannot begin with a digit.
<code>change*color*Button</code>	Illegal because the <code>*</code> character is not allowed.
<code>displayTotalButton</code>	Legal
<code>calculate Tax Button</code>	Illegal because identifiers cannot contain spaces.

Because a control's name should reflect the control's purpose, programmers often find themselves creating names that are made of multiple words. For example, consider the following Button control names:

```
calculatetaxbutton
printreportbutton
displayanimationbutton
```

Unfortunately, these names are not easily read by the human eye because the words are not separated. Because we cannot have spaces in control names, we need to find another way to separate the words in a multiword control name to make it more readable to the human eye.

Most C# programmers address this problem by using the **camelCase** naming convention for controls. camelCase names are written in the following manner:

- You begin writing the name with lowercase letters.
- The first character of the second and subsequent words is written in uppercase.

For example, the following control names are written in camelCase:

```
calculateTaxButton
printReportButton
displayAnimationButton
```



**NOTE:** This style of naming is called camelCase because the uppercase characters that appear in a name are sometimes reminiscent of a camel's humps.



## Checkpoint

- 2.1 When you start a new Visual C# project, what is automatically created and displayed in the *Designer*?
- 2.2 How can you tell that an object is selected and ready for editing in the *Designer*?
- 2.3 What is the purpose of an object's sizing handles?
- 2.4 What must each form and control in an application's GUI have to identify it?
- 2.5 What is the purpose of the *Properties* window?
- 2.6 What does the Alphabetical button do when it is selected in the *Properties* window?
- 2.7 What does the Categorized button do when it is selected in the *Properties* window?
- 2.8 What does a form's Text property determine?
- 2.9 What does a form's Size property determine?
- 2.10 What is shown in the *Toolbox*?
- 2.11 How do you add a control to a form?
- 2.12 What should the text that is displayed on a button indicate?
- 2.13 What are the rules for naming controls?
- 2.14 What naming convention do most C# programmers use to separate words in a multiword identifier?

## 2.2

## Creating the GUI for Your First Visual C# Application: The *Hello World* Application

When a student is learning computer programming, it is traditional to start by learning to write a *Hello World* program. A *Hello World* program is a simple program that merely displays the words “*Hello World*” on the screen. In this chapter you will create your first Visual C# application, which will be an event-driven *Hello World* program. When the finished application runs, it will display the form shown on the left in Figure 2-14. Notice that the form contains a button that reads *Display Message*. When you click the button, the window shown on the right in the figure will appear.

**Figure 2-14** Screens displayed by the completed *Hello World* program

The process of creating this application is divided into two parts. First, you will create the application's GUI, and second, you will write the code that causes the *Hello World* message to appear when the user clicks the *Display Message* button. Tutorial 2-1 leads you through the process of creating the GUI.



VideoNote

**Tutorial 2-1:**  
Creating the GUI for the  
*Hello World*  
Application

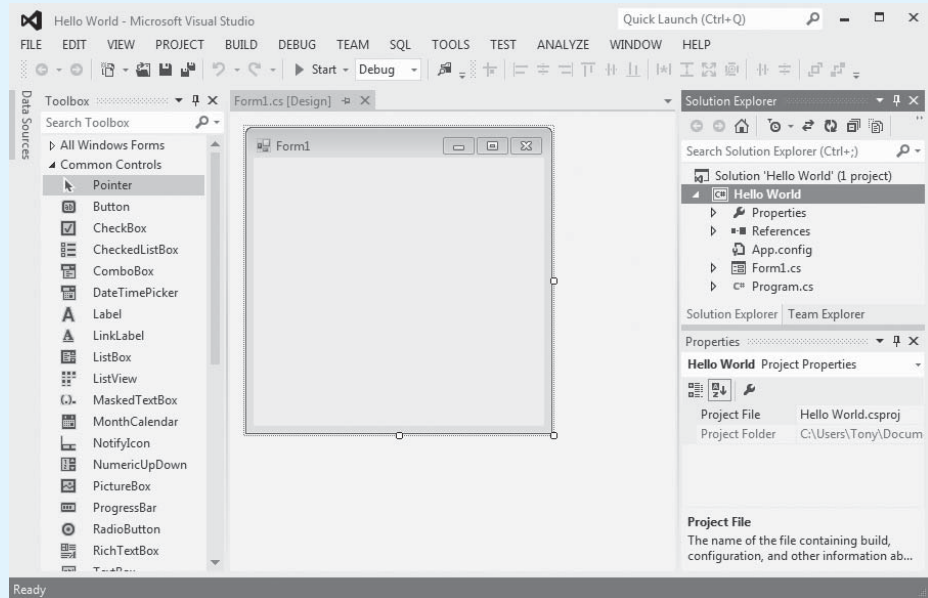
## Tutorial 2-1:

### Creating the GUI for the *Hello World* Application

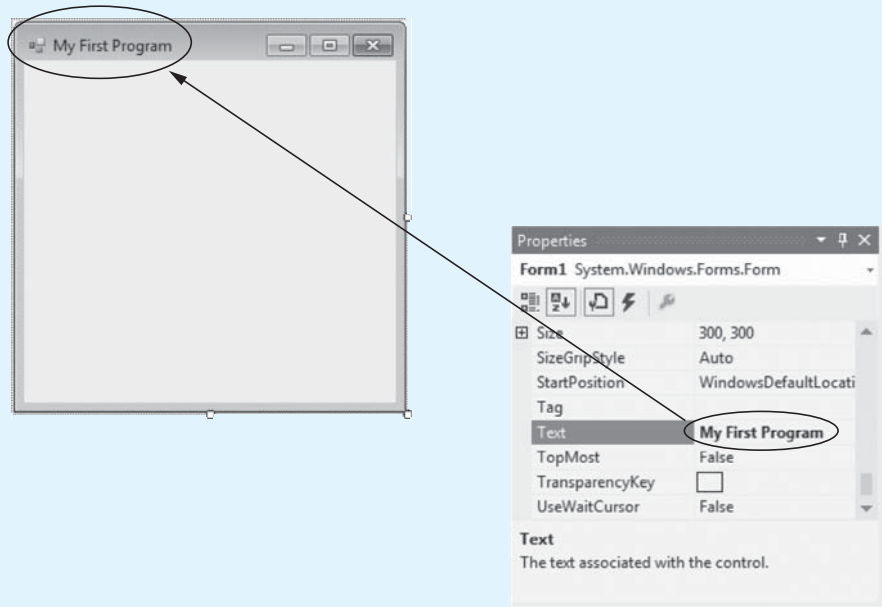
- Step 1:** Start Visual Studio (or Visual Studio Express).
- Step 2:** Start a new project by performing one of the following actions:
- If you are using Visual Studio, click *FILE* on the menu bar, then select *New*, and then select *Project...*
  - If you are using Visual Studio Express, click *FILE* on the menu bar and then select *New Project...*
- Step 3:** The *New Project* window should appear. At the left side of the window, under *Installed > Templates*, make sure *Visual C#* is selected. Then, select *Windows Forms Application* as the type of application. In the *Name* text box (at the bottom of the window), change the name of the project to *Hello World*, and then click the *Ok* button.
- Step 4:** Make sure the *Toolbox*, the *Solution Explorer*, and the *Properties* window are visible and that Auto Hide is turned off for each of these windows. The Visual Studio environment should appear as shown in Figure 2-15.
- Step 5:** Change the *Form1* form's *Text* property to *My First Program*, as shown in Figure 2-16.
- Step 6:** The form's default size is too large for this application, so you need to make it smaller. Use the technique discussed in the previous section to adjust the form's size with the mouse. The form should appear similar to that shown in Figure 2-17. (Don't worry about the form's exact size. Just make it appear similar to Figure 2-17.)
- Step 7:** Now you are ready to add a *Button* control to the form. Locate the *Button* tool in the *Toolbox* and double-click it. A *Button* control should appear on the form, as shown in Figure 2-18. Move the *Button* control so it appears approximately in the center of the form, as shown in Figure 2-19.



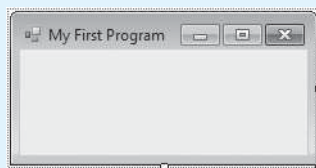
**Figure 2-15** The Visual Studio environment

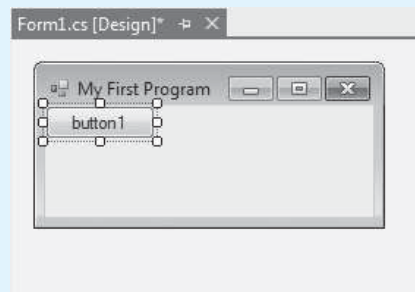
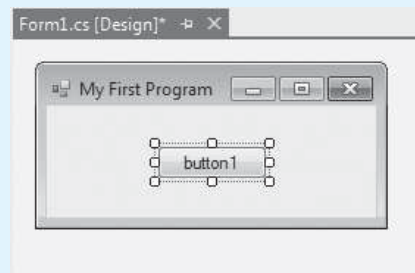


**Figure 2-16** The form's Text property changed to *My First Program*

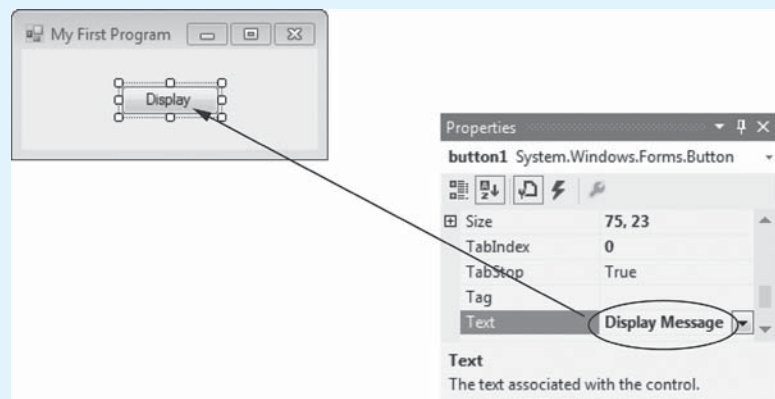


**Figure 2-17** The form resized

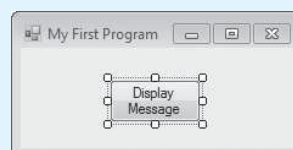


**Figure 2-18** A Button control created on the form**Figure 2-19** The Button control moved

**Step 8:** Change the value of the Button control's Text property to *Display Message*. After doing this, notice that the text displayed on the button has changed, as shown in Figure 2-20.

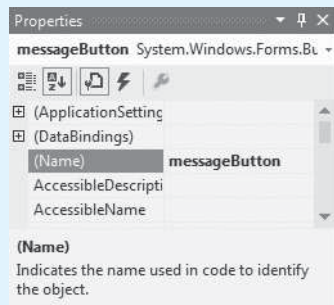
**Figure 2-20** The Button control's Text property changed

**Step 9:** The Button control isn't quite large enough to accommodate all of the text that you typed into its Text property, so enlarge the Button control, as shown in Figure 2-21.

**Figure 2-21** The Button control enlarged

**Step 10:** As discussed in the previous section, a control's name should reflect the purpose of the control. The Button control that you created in this application will cause a message to be displayed when it is clicked. The name `button1` does not convey that purpose, however. Change the Button control's Name property to `messageButton`. The *Properties* window should appear as shown in Figure 2-22.

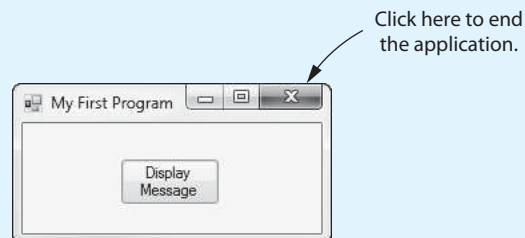
**Figure 2-22** The Button control's Name property changed to `messageButton`



**Step 11:** Click *FILE* on the Visual Studio menu bar and then click *Save All* to save the project.

**Step 12:** You're only partially finished with the application, but you can run it now to see how the GUI looks on the screen. To run the application, press the `(F5)` key on the keyboard or click the *Start Debugging* button (🐞) on the toolbar. This causes the application to be compiled and executed. You will notice the appearance of the Visual Studio environment change somewhat, and you will see the application's form appear on the screen as shown in Figure 2-23.

**Figure 2-23** The application running



Although the application is running, it is not capable of doing anything other than displaying the form. If you click the *Display Message* button, nothing will happen. That is because you have not yet written the code that executes when the button is clicked. You will do that in the next tutorial. To end the application, click the standard Windows close button (✕) in the form's upper-right corner.

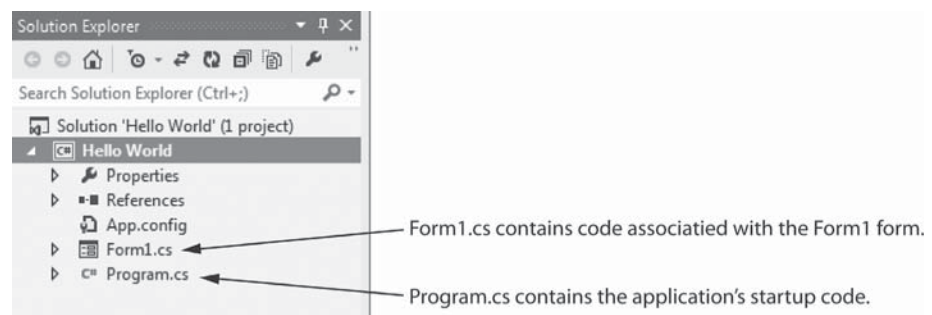
## 2.3 Introduction to C# Code

**CONCEPT:** You use the Visual Studio code editor to write an application's code. Much of the code that you will write in an application will be event handlers. Event handlers respond to specific events that take place while an application is running.

In the previous sections of this chapter, you learned the basics of creating an application's GUI. An application is more than a user interface, however. If you want your application to perform any meaningful actions, you have to write code. This section introduces you to Visual C# code and shows how to program an application to respond to button clicks.

A file that contains program code is called a **source code file**. When you start a C# Windows Forms Application project, Visual Studio automatically creates several source code files and adds them to the project. If you look at the *Solution Explorer*, as shown in Figure 2-24, you will see the names of two source code files: *Form1.cs* and *Program.cs*. (C# source code files always end with the *.cs* extension.)

**Figure 2-24** Source code files shown in the *Solution Explorer*



Here is a brief description of the two files:

- The **Program.cs** file contains the application's start-up code, which executes when the application runs. The code in this file performs behind-the-scenes initialization tasks that are necessary to get the application up and running. It is important that you do not modify the contents of this file because doing so could prevent the application from executing.
- The **Form1.cs** file contains code that is associated with the Form1 form. When you write code that defines some action related to Form1 (such as responding to a button click), you will write the code in this file.

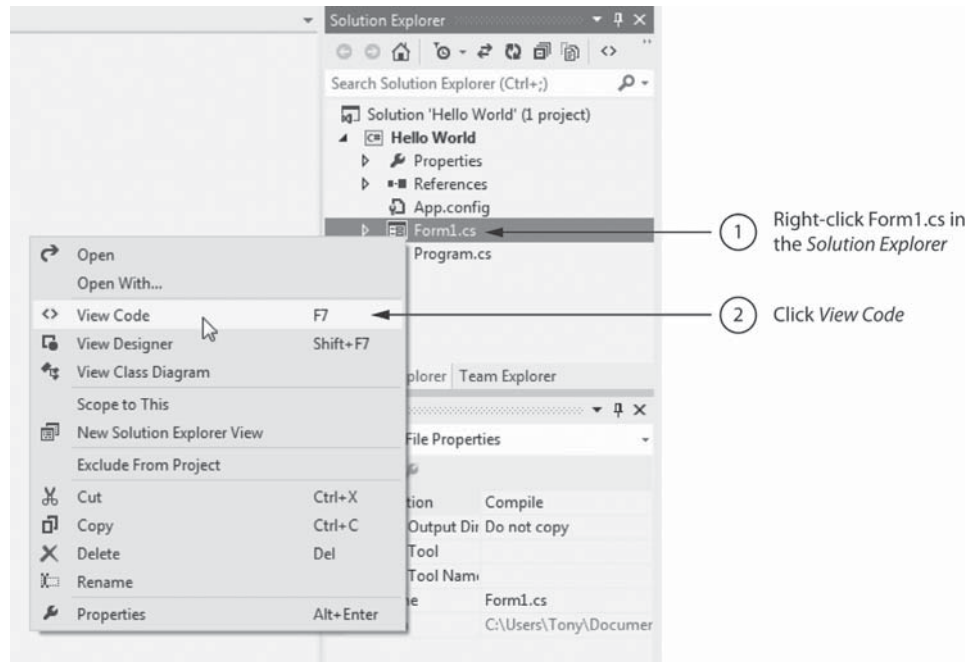


**NOTE:** You might see additional source code files in the *Solution Explorer*, other than those shown in Figure 2-24.

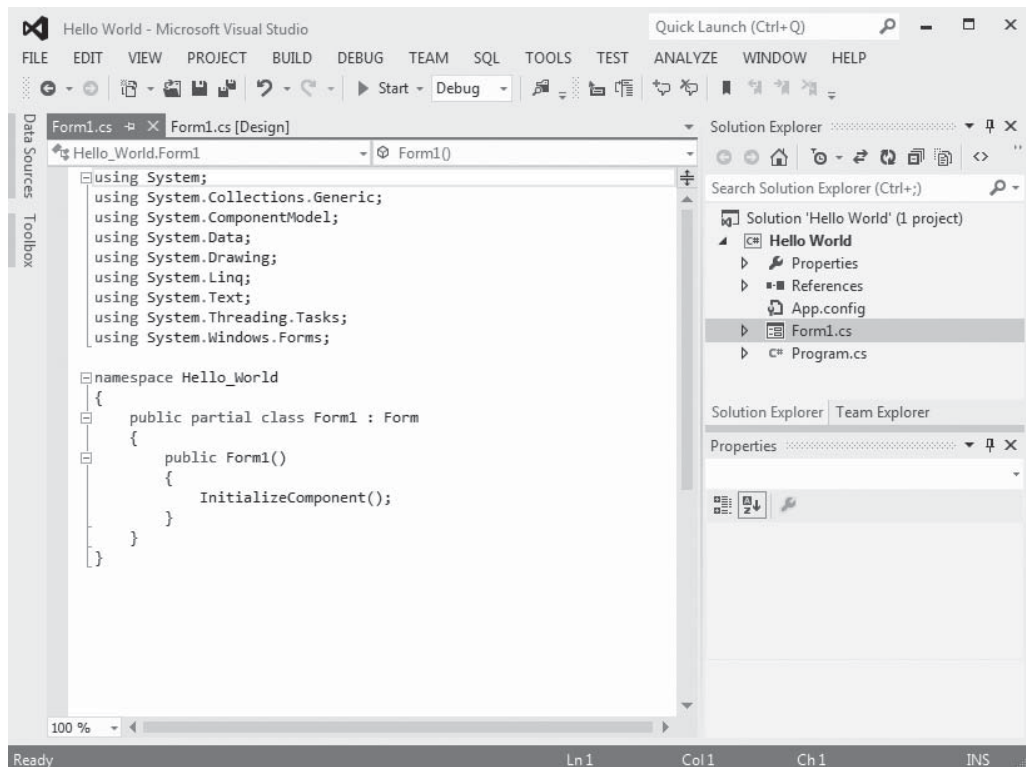
The *Form1.cs* file already contains code that was generated by Visual Studio when the project was created. You can think of this auto-generated code as an outline to which you can add your own code as you develop the application.

Let's take a look at the code. If you still have the *Hello World* project open from the previous tutorial, right-click *Form1.cs* in the *Solution Explorer*. A pop-up menu will appear, as shown in Figure 2-25. On the pop-up menu, click *View Code*. The file's contents will be displayed in the Visual Studio code editor, as shown in Figure 2-26.

**Figure 2-25** Opening *Form1.cs* in the code editor



**Figure 2-26** *Form1.cs* code displayed in the Visual Studio code editor

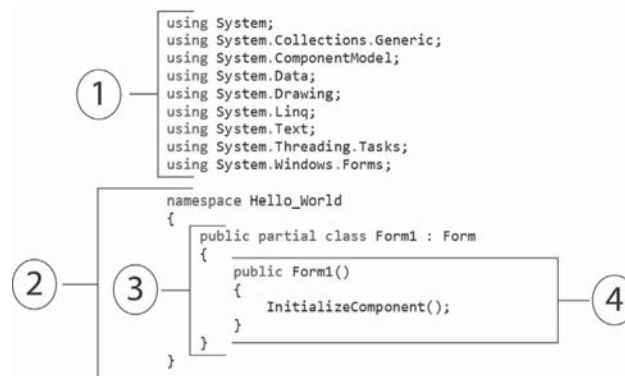


At this point, it's not necessary for you to understand the meaning of the statements that you see in this code. It will be helpful for you to know how this code is organized, however, because later you will add your own code to this file. C# code is primarily organized in three ways: namespaces, classes, and methods. Here's a summary:

- A **namespace** is a container that holds classes.
- A **class** is a container that holds methods (among other things).
- A **method** is a group of one or more programming statements that performs some operation.

So, C# code is organized as methods, which are contained inside classes, which are contained inside namespaces. With this organizational structure in mind, look at Figure 2-27.

**Figure 2-27** Organization of the Form1.cs code



The figure shows four different sections of the code, marked with the numbers 1, 2, 3, and 4. Let's discuss each section of code.

- ① Recall from Chapter 1 that C# applications rely heavily on the .NET Framework, which is a collection of classes and other code. The code in the .NET Framework is organized into namespaces. The series of `using` directives that appears at the top of a C# source code file indicate which namespaces in the .NET Framework the program will use.
- ② This section of code creates a namespace for the project. The line that reads `namespace Hello_World` marks the beginning of a namespace named `Hello_World`. Notice that the next line contains an opening brace (`{`) and that the last line in the file contains a corresponding closing brace (`}`). All the code that appears between these braces is inside the `Hello_World` namespace.
- ③ This section of code is a class declaration. The line that reads `public partial class`, and so forth, marks the beginning of the class. The next line contains an opening brace (`{`), and the last line in this section of code contains a corresponding closing brace (`}`). All the code that appears between these braces is inside the class.
- ④ This section of code is a method. The line that reads `public Form1()` marks the beginning of the method. The next line contains an opening brace (`{`), and the last line in this section of code contains a corresponding closing brace (`}`). The code that appears between these braces is inside the method.

It's important to point out that code containers, such as namespaces, classes, and methods, use **braces** (`{}`) to enclose code. Each opening brace (`{`) must have a corresponding

closing brace (}) at some later point in the program. Figure 2-28 shows how the braces in Form1.cs are paired.

**Figure 2-28** Corresponding braces

```

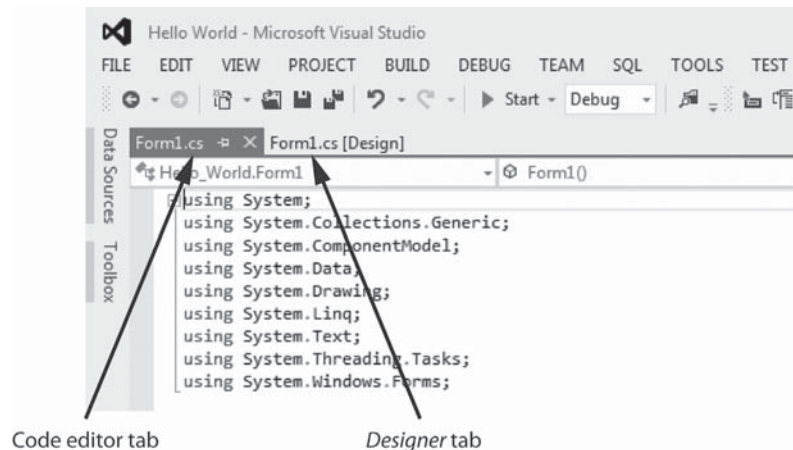
namespace Hello_World
{
    public partial class Form1 : Form
    {
        public Form1()
        {
            InitializeComponent();
        }
    }
}

```

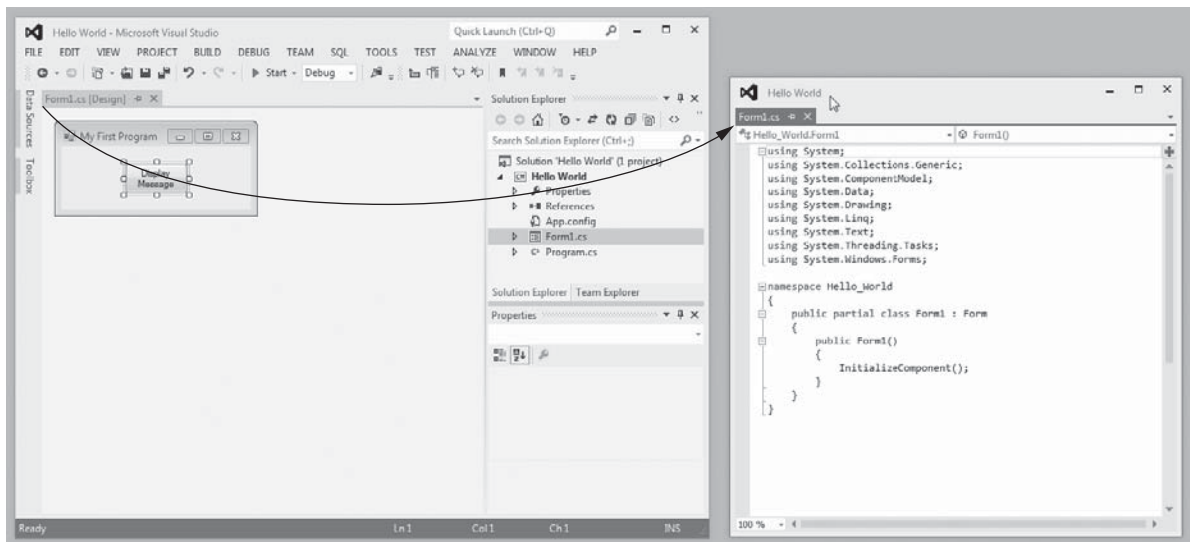
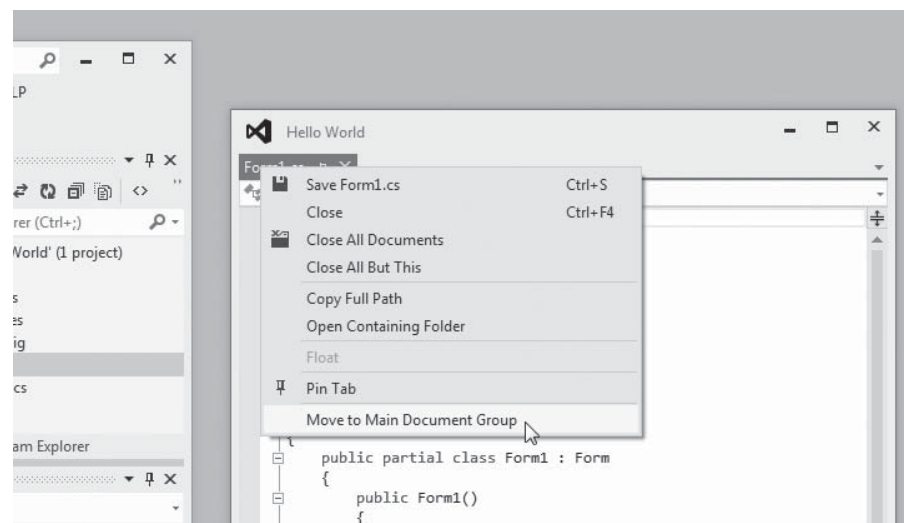
## Switching between the Code Editor and the Designer

When you open the code editor, it appears in the same part of the screen as the *Designer*. While developing a Visual C# application, you will often find yourself needing to switch back and forth between the *Designer* and the code editor. One way to quickly switch between the two windows is to use the tabs shown in Figure 2-29. In the figure, notice that the leftmost tab reads *Form1.cs*. That is the tab for the code editor. The rightmost tab reads *Form1.cs [Design]*. That is the tab for the *Designer*. (The tabs may not always appear in this order.) To switch between the *Designer* and the code editor, you simply click the tab for the desired window.

**Figure 2-29** Code editor and *Designer* tabs



You can also detach the code editor and move it to another part of the screen. This allows you to see the code editor and the *Designer* at the same time. As shown in Figure 2-30, click the code editor tab and drag it to the desired location on the screen. (If you have multiple monitors connected to your computer, you can even drag the code editor to a different monitor.) To return the code editor to its position within the IDE, right-click the tab for the source code file in the code editor window and select *Move to Main Document Group*. This is shown in Figure 2-31.

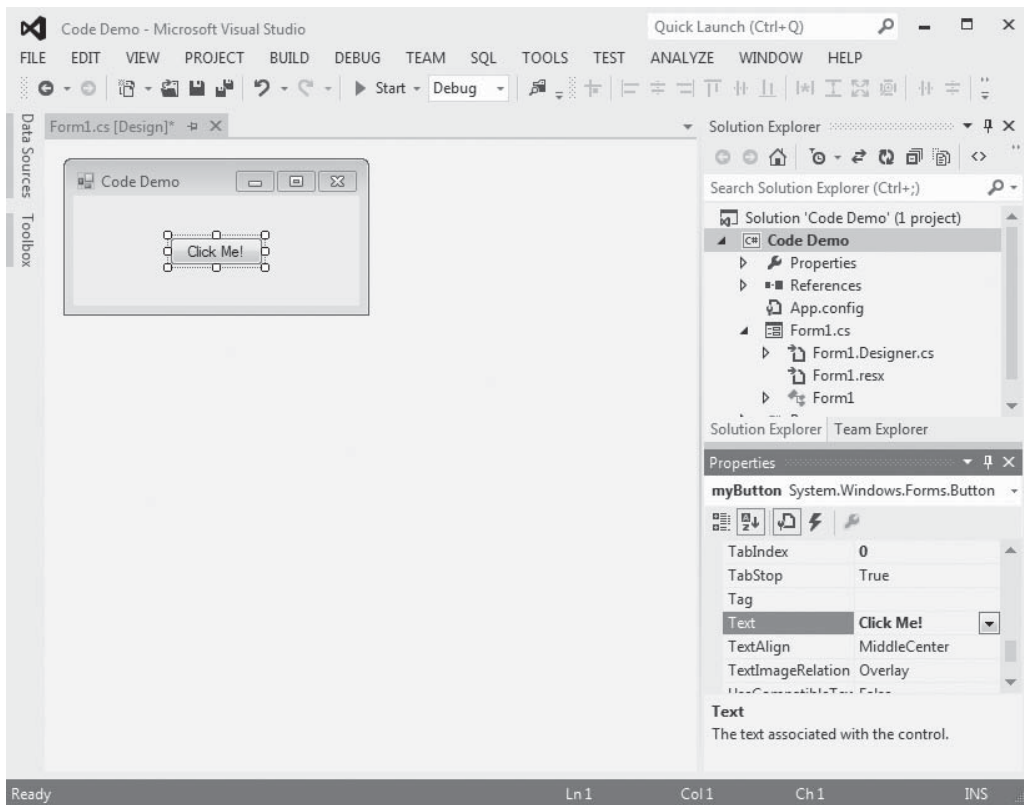
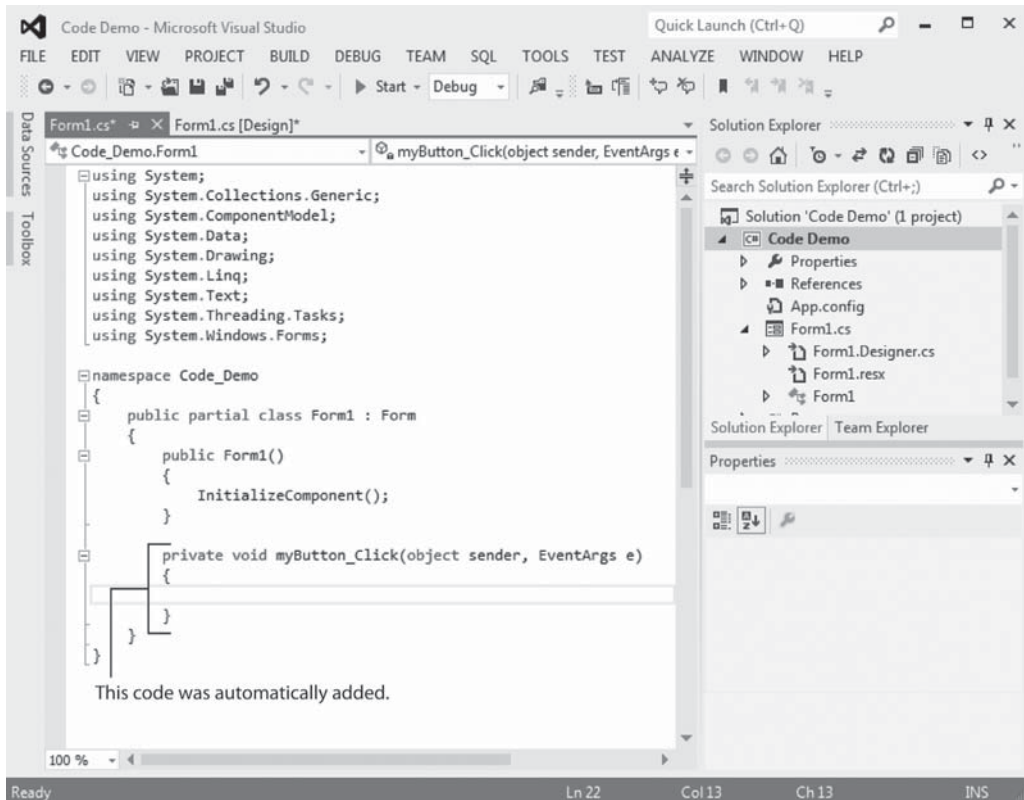
**Figure 2-30** Detaching the code editor by clicking and dragging**Figure 2-31** Returning the code editor to its docked position

## Adding Your Own Code to a Project

Now you are ready to learn how to add your own code to a project. Suppose you have created a project named *Code Demo* and set up the project's form with a Button control, as shown in Figure 2-32. The Button control's name is `myButton`, and its Text property is set to *Click Me!*.

Suppose you want the application to display the message *Thanks for clicking the button!* when the user clicks the button. To accomplish that, you need to write a special type of method known as an event handler. An **event handler** is a method that executes when a specific event takes place while an application is running. In this project you need to write an event handler that will execute when the user clicks the `myButton` control. To create the event handler, you double-click the `myButton` control in the *Designer*. This opens the `Form1.cs` file in the code editor, as shown in Figure 2-33, with some new code added to it.



**Figure 2-32** A form with a Button control**Figure 2-33** The code window opened with event handler code generated

When an application is running and the user clicks a control, we say that a **Click event** has occurred on the control. The code that has been added to the Form1.cs file (shown in Figure 2-33) is an event handler that will execute when a Click event occurs on the `myButton` control. For now you do not need to understand all parts of the event handler code. At this point you need to understand only the following concepts:

- As shown in Figure 2-34, the event handler's name is `myButton_Click`. The "myButton" portion of the name indicates that the event handler is associated with the `myButton` control, and the "Click" portion of the name indicates that the event handler responds to Click events. This is the typical naming convention that Visual Studio uses when it generates event handler code. When you see the name `myButton_Click`, you understand that it is an event handler that executes when a Click event occurs on the `myButton` control.

**Figure 2-34** A closer look at the event handler code

The event handler's name

```
private void myButton_Click(object sender, EventArgs e)
{
}

```

Your code goes here, between the braces.

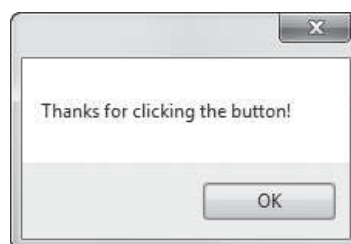
- The event handler that Visual Studio generates doesn't actually do anything. You can think of it as an empty container to which you can add your own code. Notice that the second line of the event handler is an opening brace (`{`) and the last line is a closing brace (`}`). Any code that you want executed when the user clicks the `myButton` control must be written between these braces.

Now you know how to create an empty Click event handler for a Button control. But what code do you write inside the event handler? In this example we write code that displays the message *Thanks for clicking the button!* in a message box, which is a small pop-up window.

## Message Boxes

A **message box** is a small window, sometimes referred to as a **dialog box**, that displays a message. Figure 2-35 shows an example of a message box displaying the message *Thanks for clicking the button!* Notice that the message box also has an **OK** button. When the user clicks the **OK** button, the message box closes.

**Figure 2-35** A message box



The .NET Framework provides a method named `MessageBox.Show` that you can use in Visual C# to display a message box. If you want to execute the `MessageBox.Show` method, you write a statement known as a **method call**. (Programmers refer to the act of executing a method as *calling* the method.) The following statement shows an example of how you would call the `MessageBox.Show` method to display the message box shown in Figure 2-35:

```
MessageBox.Show("Thanks for clicking the button!");
```

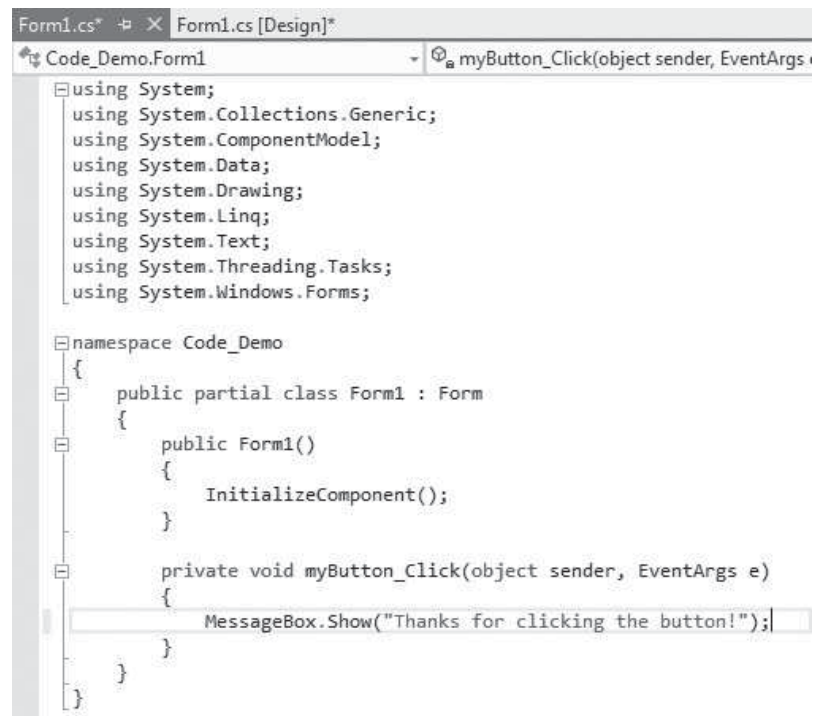
When you call the `MessageBox.Show` method, you write a string of characters inside the parentheses. (In programming we use the term **string** to mean string of characters.) The string that is written inside the parentheses will be displayed in the message box. In this example the string "Thanks for clicking the button!" is written inside the parentheses.

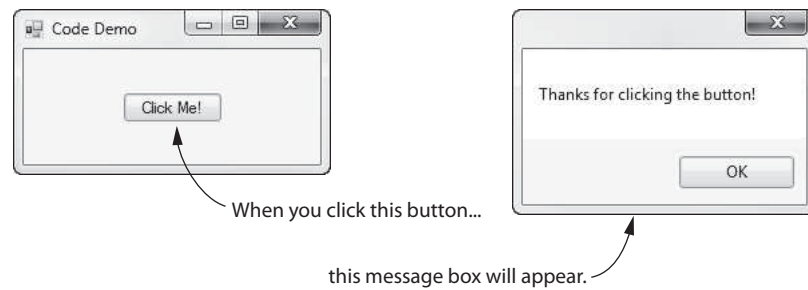
Notice that the string is enclosed in double quotation marks in the code. When the message is displayed (as shown in Figure 2-35), however, the double quotation marks do not appear. The double quotation marks are required in the code to indicate the beginning and the end of the string.

Also notice that a semicolon appears at the end of the statement. This is required by C# syntax. Just as a period marks the end of a sentence, a **semicolon** marks the end of a programming statement in C#.

Getting back to our *Code Demo* example project, Figure 2-36 shows how you can call the `MessageBox.Show` method from the `myButton_Click` event handler. After typing the statement as shown in the figure, you can press the (F5) key on the keyboard, or click the *Start Debugging* button (🐞) on the toolbar to compile and run the application. When the application runs, it will display the form shown on the left in Figure 2-37. When you click the button, the message box shown on the right in the figure will appear. You can click the *OK* button on the message box to close it.

**Figure 2-36** Event handler code for displaying a message box



**Figure 2-37** The *Code Demo* project running

**NOTE:** When writing a Click event handler for a Button control, you might be wondering if it is necessary to first double-click the Button control in the *Designer*, creating the empty event handler code. After all, couldn't you just skip this step and instead open the code editor and write all the event handler code yourself? The answer is no, you cannot skip this step. When you double-click a control in the *Designer*, Visual Studio not only creates an empty event handler, but it also writes some code that you don't see elsewhere in the project. This other code is necessary for the event handler to properly function.

## String Literals

Programs almost always work with data of some type. For example, the code shown in Figure 2-36 uses the following string when it calls the `MessageBox.Show` method:

```
"Thanks for clicking the button!"
```

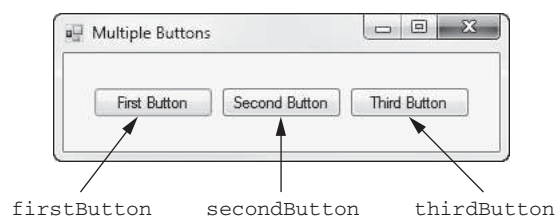
This string is the data that is displayed by the program. When a piece of data is written into a program's code, it's called a **literal** (because the data is *literally* written into the program). When a string is written into a program's code, it's called a *string literal*. In C#, string literals must be enclosed in double quotation marks.



**NOTE:** Programmers sometimes say that literals are values that are *hard coded* into a program because the value of a literal cannot change while the program is running.

## Multiple Buttons with Event Handlers

The *Code Demo* project previously shown has only one button with a Click event handler. Many of the applications that you will develop will have multiple buttons, each with its own Click event handler. For example, the form shown in Figure 2-38 has three Button controls. As shown in the figure, the controls are named `firstButton`, `secondButton`, and `thirdButton`.

**Figure 2-38** A form with multiple Button controls

To create Click event handlers for the buttons, you simply double-click each Button control in the *Designer* and an empty event handler will be created in the form's source code file. The names of the Click event handlers will be `firstButton_Click`, `secondButton_Click`, and `thirdButton_Click`. Figure 2-39 shows an example of the form's source code after the three event handlers have been created and a `MessageBox.Show` statement has been added to each one.

**Figure 2-39** Source code with three Click event handlers

```
using System;
using System.Collections.Generic;
using System.ComponentModel;
using System.Data;
using System.Drawing;
using System.Linq;
using System.Text;
using System.Threading.Tasks;
using System.Windows.Forms;

namespace Multiple_Buttons
{
    public partial class Form1 : Form
    {
        public Form1()
        {
            InitializeComponent();
        }

        private void firstButton_Click(object sender, EventArgs e)
        {
            MessageBox.Show("You clicked the first button.");
        }

        private void secondButton_Click(object sender, EventArgs e)
        {
            MessageBox.Show("You clicked the second button.");
        }

        private void thirdButton_Click(object sender, EventArgs e)
        {
            MessageBox.Show("You clicked the third button.");
        }
    }
}
```

## Design Time and Run Time

When you have a project open in Visual Studio, the time during which you build the GUI and write the application's code is referred to as **design time**. During design time, you can use the *Designer* and the *Toolbox* to place controls on the form, use the *Properties* window to set property values, use the code editor to write code, and so forth. This is the phase during which you create or modify the application.

When you are ready to run a project that you have open in Visual Studio, you press the **F5** key on the keyboard or click the *Start Debugging* button (🐞) on the toolbar. The project will be compiled, and if there were no errors, it will be executed. The time during which an application is executing is referred to as **run time**. During run time, you can interact with the running application, but you cannot use the *Designer*, the *Toolbox*, the *Properties* window, the code editor, or parts of Visual Studio to make changes to it.



**NOTE:** In computing literature and on the Web, you will see the term *run time* also spelled as *runtime* or *run-time*. All these variations typically mean the same thing.



### Checkpoint

- 2.15 A file that contains program code is known as what type of file?
- 2.16 What must you do if you want your application to perform any meaningful actions?
- 2.17 What does the Program.cs file contain?
- 2.18 What does the Form1.cs file contain?
- 2.19 How is C# code organized?
- 2.20 What is a namespace?
- 2.21 What characters do code containers, such as namespaces, classes, and methods, use to enclose code?
- 2.22 How do you switch between the *Designer* and the code editor?
- 2.23 How do you create an event handler for a button?
- 2.24 What is a Click event?
- 2.25 What method do you use in Visual C# to display a message box?
- 2.26 What is a literal?
- 2.27 What are string literals enclosed in?
- 2.28 How do you run a project that you have open in Visual Studio?

## 2.4

## Writing Code for the *Hello World* Application

Now you know everything necessary to complete the *Hello World* project. In Tutorial 2-2 you will open the project and add a Click event handler for the `messageButton` control. The event handler will call the `MessageBox.Show` method to display a message box with the message *Hello World*.



VideoNote

**Tutorial 2-2:**  
Writing  
Code for the  
*Hello World*  
Application

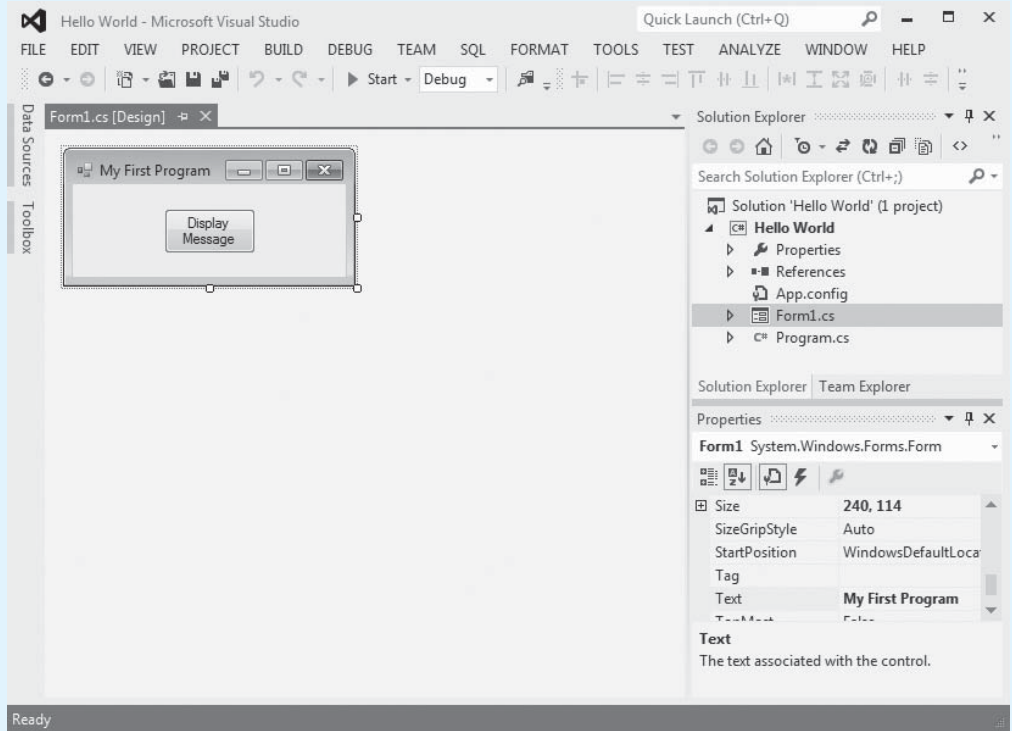


### Tutorial 2-2:

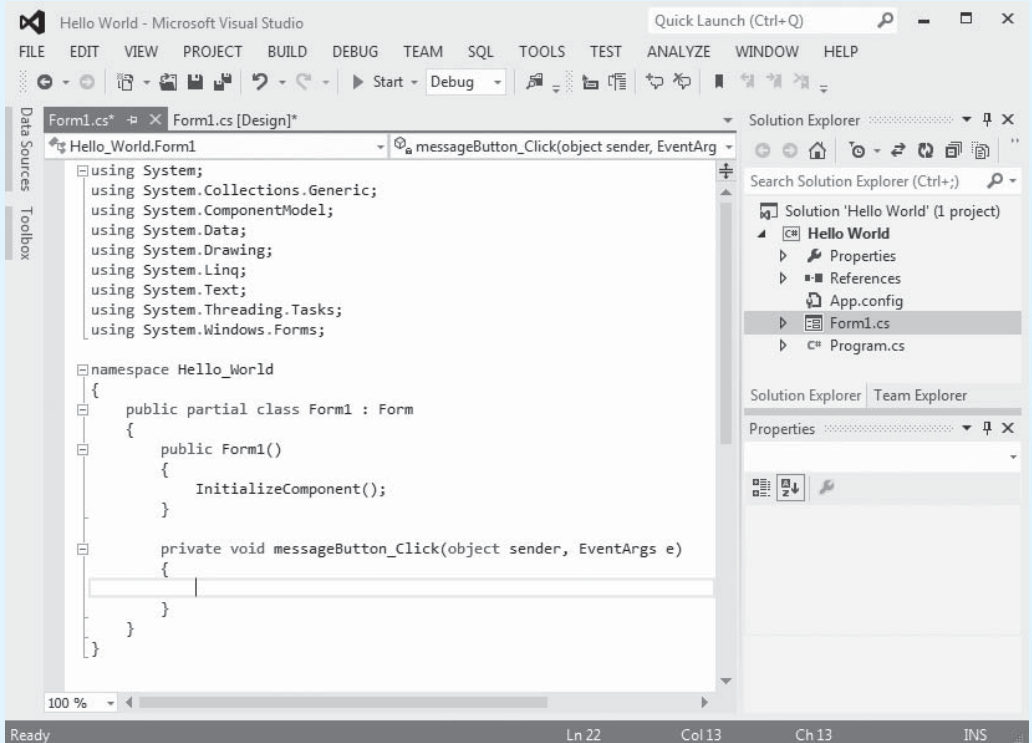
#### Writing Code for the *Hello World* Application

- Step 1:** If Visual Studio (or Visual Studio Express) is not already running, start it. Open the *Hello World* project that you started in Tutorial 2-1.
- Step 2:** Make sure the Form1 form is visible in the *Designer*, as shown in Figure 2-40. If it is not, right-click Form1.cs in the *Solution Explorer* and then select *View Designer* from the pop-up menu.
- Step 3:** In the *Designer*, double-click the `messageButton` control. This should cause the code editor to appear as shown in Figure 2-41. Notice that an empty event handler named `messageButton_Click` has been created.

**Figure 2-40** The *Hello World* project loaded with Form1 shown in the *Designer*



**Figure 2-41** Code editor with an empty event handler

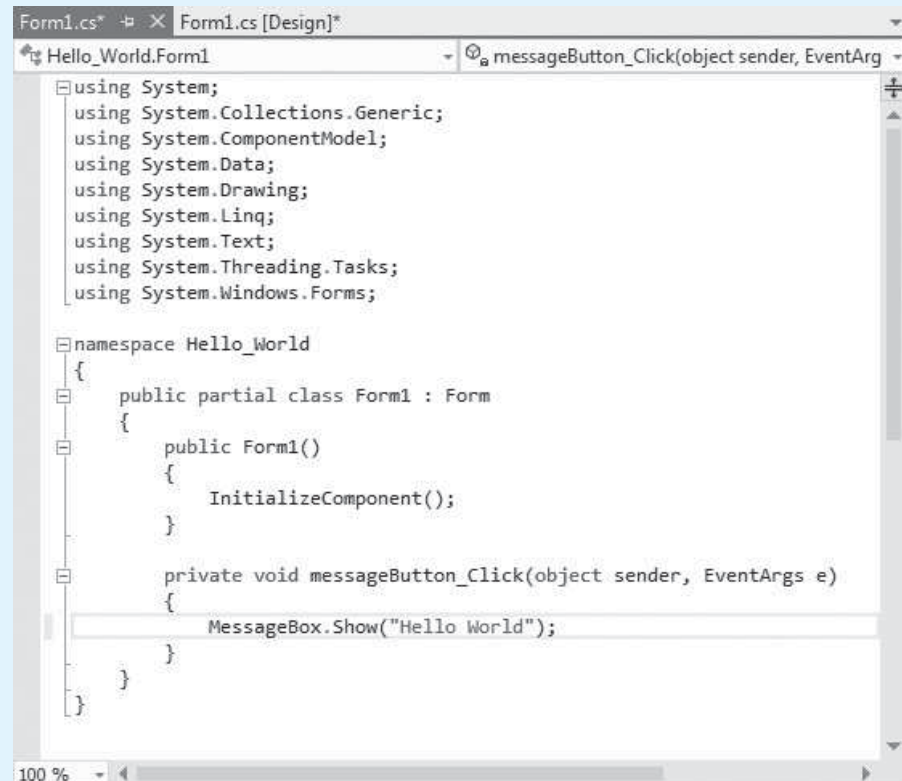


**Step 4:** Inside the `messageButton_Click` event handler, type the following statement exactly as it is shown:

```
MessageBox.Show("Hello World");
```

Don't forget to type the semicolon at the end of the statement! When you have finished, the code window should look like Figure 2-42.

**Figure 2-42** Statement written inside the event handler




```
Form1.cs*  Form1.cs [Design]*
Hello_World.Form1  messageButton_Click(object sender, EventArgs e)
using System;
using System.Collections.Generic;
using System.ComponentModel;
using System.Data;
using System.Drawing;
using System.Linq;
using System.Text;
using System.Threading.Tasks;
using System.Windows.Forms;

namespace Hello_World
{
    public partial class Form1 : Form
    {
        public Form1()
        {
            InitializeComponent();
        }

        private void messageButton_Click(object sender, EventArgs e)
        {
            MessageBox.Show("Hello World");
        }
    }
}
```

**Step 5:** Save the project.

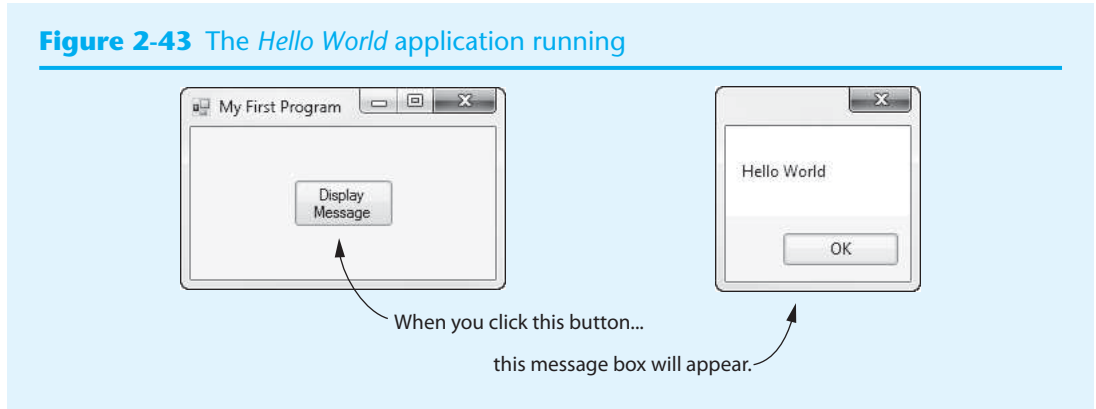
**Step 6:** Press the **(F5)** key on the keyboard, or click the *Start Debugging* button (  ) on the toolbar to compile and run the application.



**NOTE:** If you typed the statement correctly inside the `messageButton_Click` event handler (in Step 4), the application should run. If you did not type the statement correctly, however, a window will appear reporting build errors. If that happens, click the *No* button in the window and then correct the statement so it appears exactly as shown in Figure 2-42.

When the application runs, it will display the form shown on the left in Figure 2-43. When you click the *Display Message* button, the message box shown on the right in the figure will appear. You can click the *OK* button on the message box to close it.

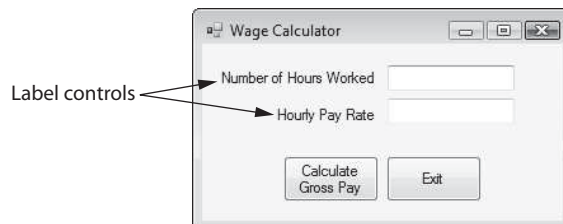


**Figure 2-43** The *Hello World* application running

## 2.5 Label Controls

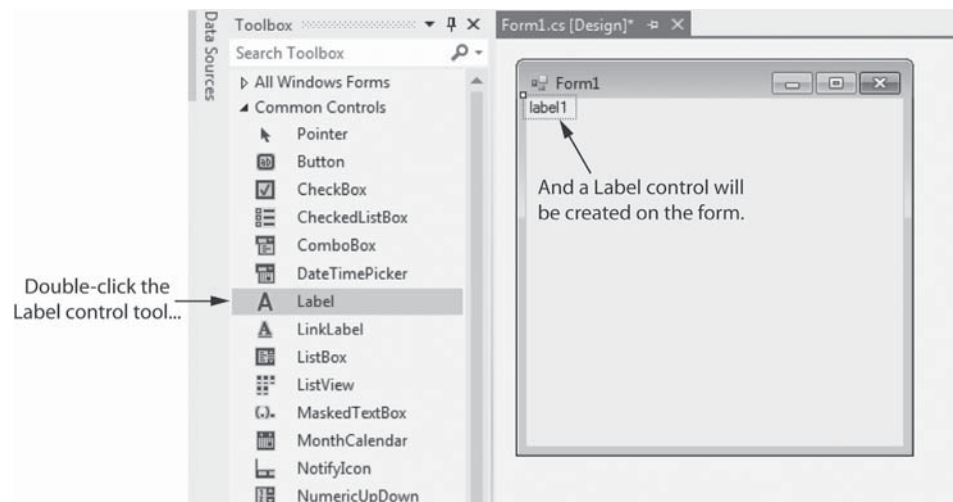
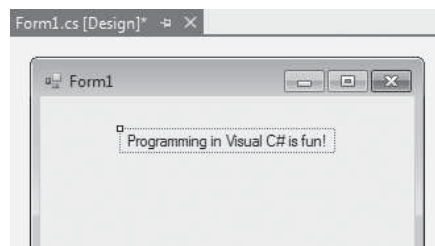
**CONCEPT:** A label control displays text on a form. Label controls have various properties that affect the control's appearance. Label controls can be used to display unchanging text, or program output.

When you want to display text on a form, you use a **Label control**. Figure 2-44 shows an example of a form with two Label controls. Once you have placed a Label control on a form, you set its `Text` property to the text that you want to display. For example, in Figure 2-44, the upper Label control's `Text` property is set to *Number of Hours Worked*, and the lower Label control's `Text` property is set to *Hourly Pay Rate*.

**Figure 2-44** A form with Label controls

You'll find the Label control tool in the *Common Controls* group of the *Toolbox*, as shown in Figure 2-45. To create a Label control on a form, you double-click the Label control tool in the *Toolbox*. As shown in Figure 2-45, a Label control will be created on the form. (Alternatively, you can click and drag the Label control tool from the *Toolbox* onto the form.) Notice that a bounding box appears around the Label control in the figure. This indicates that the control is currently selected.

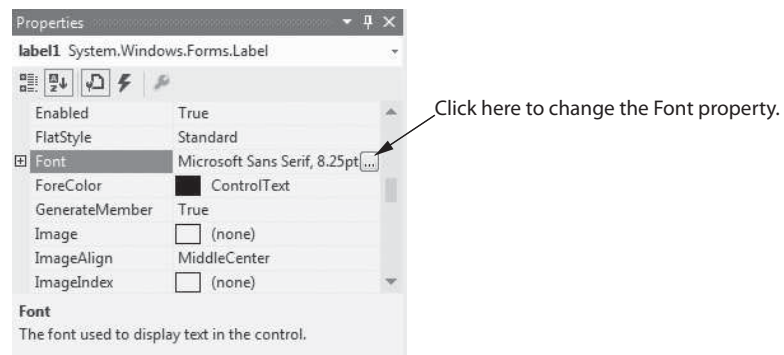
When you create Label controls, they are automatically given default names such as `label1`, `label2`, and so forth. A Label control's `Text` property is initially set to the same value as the Label control's name. So, a Label control will display its own name when it is created, as shown by the example in Figure 2-45. When a Label control is selected in the *Designer*, you can use the *Properties* window to change its `Text` property. Figure 2-46 shows a Label control after its `Text` property has been changed to *Programming in Visual C# is fun!*

**Figure 2-45** Creating a Label control**Figure 2-46** A Label control displaying a message

You can also use the *Properties* window to change a Label control's name. It's always a good idea to change a control's name to something that is more meaningful than the default name that Visual Studio gives it.

## The Font Property

If you want to change the appearance of a Label control's text, you can change the control's Font property. The **Font** property allows you to set the font, font style, and size of the control's text. When you select the Font property in the *Properties* window, you will notice that an ellipses button (⋮) appears next to the property's value, as shown in Figure 2-47. When you click the ellipses button, the *Font* dialog box appears, as shown

**Figure 2-47** The Font property

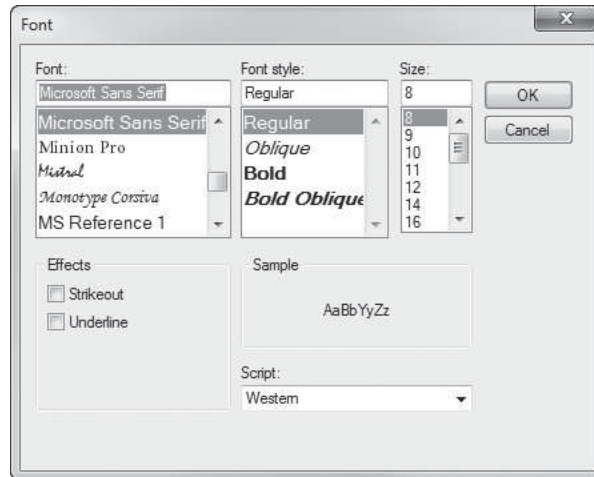
in Figure 2-48. Select a font, font style, and size, and click *OK*. The text displayed by the control will be updated with the selected attributes. For example, Figure 2-49 shows a Label control with the following Font property attributes:

Font: Lucida Handwriting

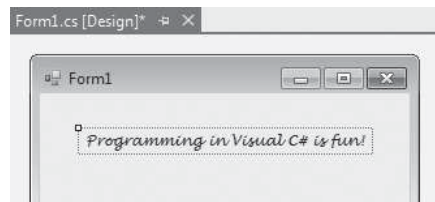
Font Style: Italic

Size: 10 point

**Figure 2-48** The *Font* dialog box



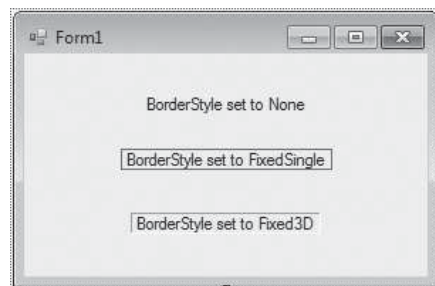
**Figure 2-49** A label's appearance with altered font attributes



## The BorderStyle Property

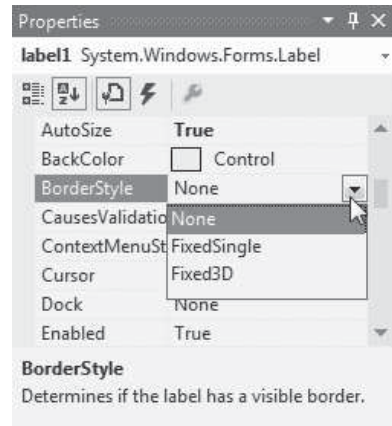
Label controls have a **BorderStyle** property that allows you to display a border around the control's text. The **BorderStyle** property may have one of three values: **None**, **FixedSingle**, or **Fixed3D**. The property is set to **None** by default, which means that no border will appear around the control's text. If the **BorderStyle** property is set to **FixedSingle**, the control's text will be outlined with a thin border. If the **BorderStyle** property is set to **Fixed3D**, the control's text will have a recessed 3D appearance. Figure 2-50 shows an example of Label controls with each **BorderStyle** setting.

**Figure 2-50** *BorderStyle* examples



To change the `BorderStyle` property, select it in the *Properties* window and then click the down-arrow button (▾) that appears next to the property's value. As shown in Figure 2-51, a drop-down list will appear containing the three possible values for this property. Select the desired value and the control's text will be updated.

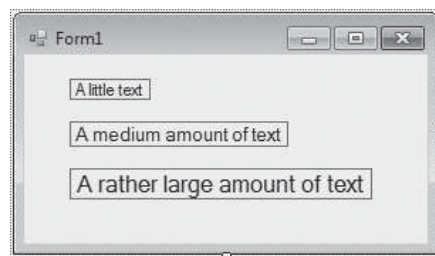
**Figure 2-51** `BorderStyle` selections



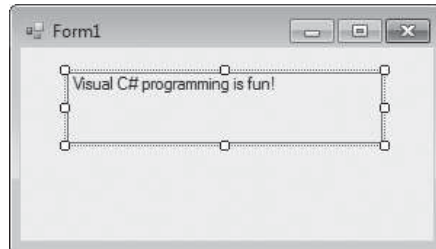
## The `AutoSize` Property

Label controls have an `AutoSize` property that controls the way they can be resized. The `AutoSize` property is a **Boolean** property, which means that it can be set to one of two possible values: `True` or `False`. By default, a Label control's `AutoSize` property is set to `True`, which means that the control automatically resizes itself to accommodate the size of the text it displays. For example, look at the three Label controls in Figure 2-52. Each of the controls displays different amounts of text at different font sizes. Because each control's `BorderStyle` property is set to `FixedSingle`, you can see that each control is just large enough to accommodate its text.

**Figure 2-52** Label controls with `AutoSize` set to `True`



When a Label control's `AutoSize` property is set to `True`, you cannot manually change the size of the control by clicking and dragging its bounding box. If you want to manually change the size of a Label control, you have to set its `AutoSize` property to `False`. When `AutoSize` is set to `False`, sizing handles will appear around the control, allowing you to click and drag the bounding box to resize the control. Figure 2-53 shows an example. In the figure, the Label control has been resized so it is much larger than the text it displays.

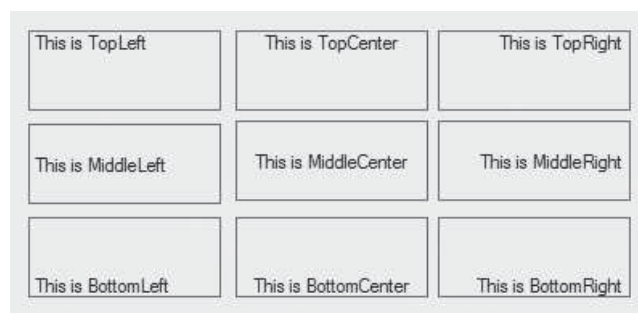
**Figure 2-53** Label control with AutoSize set to False

**NOTE:** When a Label control's AutoSize property is set to True, the label's text will always appear on one line. When the AutoSize property is set to False, the label's text will wrap across multiple lines if it is too long to fit on one line.

## The TextAlign Property

When you set a Label control's AutoSize property to False and then manually resize the control, it sometimes becomes necessary to change the way the label's text is aligned. By default, a label's text is aligned with the top and left edges of the label's bounding box. For example, look at the label shown in Figure 2-53. Notice how the text is positioned in the label's upper-left corner.

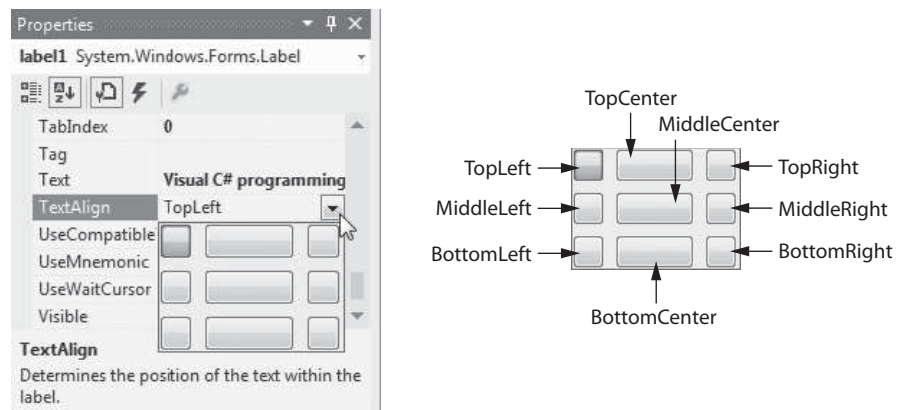
What if we want the text to be aligned differently within the label? For example, what if we want the text to be centered in the label or positioned in the lower-right corner? We can change the text's alignment in the label with the **TextAlign** property. The TextAlign property may be set to any of the following values: TopLeft, TopCenter, TopRight, MiddleLeft, MiddleCenter, MiddleRight, BottomLeft, BottomCenter, or BottomRight. Figure 2-54 shows nine Label controls, each with a different TextAlign value.

**Figure 2-54** Text alignments

To change the TextAlign property, select it in the *Properties* window and then click the down-arrow button (▾) that appears next to its value. This causes a dialog box with nine buttons, as shown in the left image in Figure 2-55, to appear. As shown in the right image in the figure, the nine buttons represent the valid settings of the TextAlign property.

## Using Code to Display Output in a Label Control

In addition to displaying unchanging text on a form, Label controls are also useful for displaying output while an application is running. For example, suppose you are creating an application that performs a calculation and you want to display the result of the calcula-

**Figure 2-55** Setting the TextAlign property

tion at a specific location on the form. Using a Label control to display the output would be an ideal solution. Here are the general steps that you would follow:

- Step 1:** While creating the application's GUI, you place a Label control on the form at the location where you want the result to be displayed. Then, in the *Properties* window, you erase the contents of the Label control's Text property. Because the control's Text property is empty, the control will not initially display anything when the application runs.
- Step 2:** In the application's code, you write the necessary statements to perform the calculation and then you store the result of the calculation in the Label control's Text property. This causes the result to be displayed on the form in the Label control.



**NOTE:** We do not discuss calculations until Chapter 3, so in this chapter we look at examples that display nonmathematical data as output in Label controls.

In code, you use an **assignment statement** to store a value in a control's property. For example, suppose you have created a Label control and named it `outputLabel1`. The following assignment statement stores the string "Thank you very much" in the control's Text property.

```
outputLabel1.Text = "Thank you very much";
```

The equal sign (=) is known as the **assignment operator**. It assigns the value that appears on its right side to the item that appears on its left side. In this example, the item on the left side of the assignment operator is the expression `outputLabel1.Text`. This is simply the `outputLabel1` control's Text property. The value on the right side of the assignment operator is the string "Thank you very much". When this statement executes, the string "Thank you very much" is assigned to the `outputLabel1` control's Text property. When this statement executes, the text *Thank you very much* is displayed in the Label control.



**WARNING!** When writing assignment statements, remember that the item receiving the value must be on the left side of the = operator. The following statement, for example, is wrong and will cause an error when you compile the program:

```
"Thank you very much" = outputLabel1; ← ERROR!
```

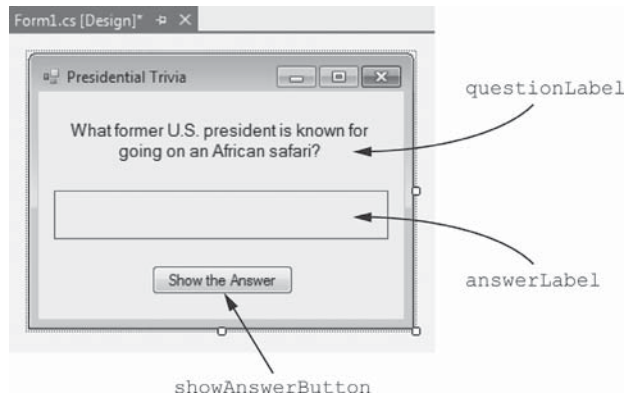


**NOTE:** The standard notation for referring to a control's property in code is:

```
ControlName.PropertyName
```

Let’s look at an example application that uses a Label control to display output. Make sure you have downloaded the student sample programs from the book’s companion Web site (at [www.pearsonhighered.com/gaddis](http://www.pearsonhighered.com/gaddis)). In the *Chap02* folder, you will find a project named *Presidential Trivia*. The purpose of the application is to display a trivia question about a former U.S. president. When the user clicks a button, the answer to the trivia question is displayed on the form. The project’s form appears as shown in Figure 2-56.

**Figure 2-56** Presidential Trivia form



As shown in the figure, the form has the three controls:

- A Label control named `questionLabel`. This label displays the trivia question.
- A Label control named `answerLabel`. This label initially appears empty, but will be used to display the answer to the trivia question.
- A Button control named `showAnswerButton`. When the user clicks this button, the answer to the trivia question is displayed.

Table 2-2 lists the property settings for each control of which you should take note.

**Table 2-2** Control property settings

Control Name	Control Type	Property Settings
<code>questionLabel</code>	Label	<b>AutoSize:</b> False <b>BorderStyle:</b> None <b>Font:</b> Microsoft Sans Serif (Style: Regular, Size: 10 point) <b>Text:</b> <i>What former U.S. president is known for going on an African safari?</i> <b>TextAlign:</b> MiddleCenter
<code>answerLabel</code>	Label	<b>AutoSize:</b> False <b>BorderStyle:</b> FixedSingle <b>Font:</b> Microsoft Sans Serif (Style: Bold, Size: 10 point) <b>Text:</b> (The contents of the Text property have been erased.) <b>TextAlign:</b> MiddleCenter
<code>showAnswerButton</code>	Button	<b>Size:</b> 110, 23 <b>Text:</b> <i>Show the Answer</i>

If we open the `Form1.cs` file in the code editor, we see the code shown in Figure 2-57. (To open the file in the code window, right-click `Form1.cs` in the *Solution Explorer* and then select *View Code*.) Notice the method named `showAnswerButton_Click`.

**Figure 2-57** Form1.cs code

```
using System;
using System.Collections.Generic;
using System.ComponentModel;
using System.Data;
using System.Drawing;
using System.Linq;
using System.Text;
using System.Threading.Tasks;
using System.Windows.Forms;

namespace Presidential_Trivia
{
    public partial class Form1 : Form
    {
        public Form1()
        {
            InitializeComponent();
        }

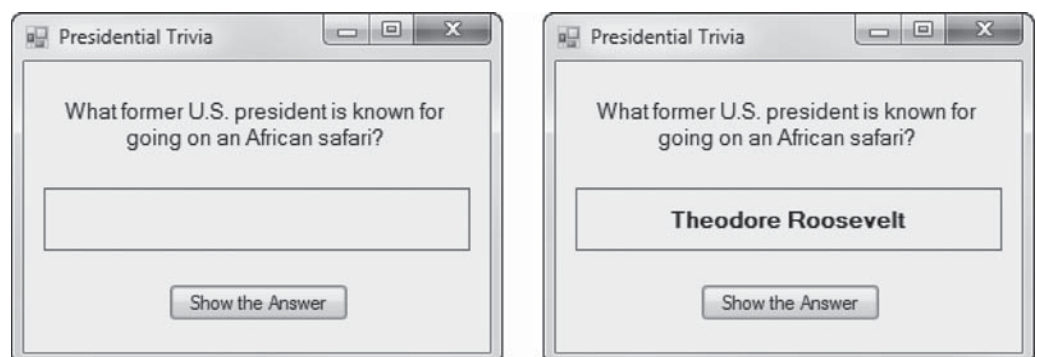
        private void showAnswerButton_Click(object sender, EventArgs e)
        {
            answerLabel.Text = "Theodore Roosevelt";
        }
    }
}
```

This is the Click event handler for the showAnswerButton control. It contains the following statement:

```
answerLabel.Text = "Theodore Roosevelt";
```

When this statement executes, it assigns the string "Theodore Roosevelt" to the answerLabel control's Text property. As a result, Theodore Roosevelt is displayed in the label control.

When you run the application, the form appears as shown on the left in Figure 2-58. Click the *Show the Answer* button and the answer to the trivia question appears as shown on the right in the figure.

**Figure 2-58** The *Presidential Trivia* application running

### The Text Property Accepts Strings Only

It is important to point out that the Label control's Text property can accept strings only. You cannot assign a number to the Text property. For example, let's assume that an



application has a Label control named `resultLabel`. The following statement will cause an error because it is attempting to store the number 5 in the `resultLabel` control's Text property:

```
resultLabel.Text = 5; ← ERROR!
```

This does not mean that you cannot display a number in a label, however. If you put quotation marks around the number, it becomes a string. The following statement will work:

```
resultLabel.Text = "5";
```

### Clearing a Label

In code, if you want to clear the text that is displayed in a Label control, simply assign an empty string ("") to the control's Text property, as shown here:

```
answerLabel.Text = "";
```

In Tutorial 2-3 you will work with some of the Label control properties that we have discussed in this section.



VideoNote

**Tutorial 2-3:**  
Creating the  
*Language  
Translator*  
Application



## Tutorial 2-3:

### Creating the *Language Translator* Application

In this tutorial you will create an application that displays the phrase “Good Morning” in different languages. The form will have three buttons: one for Italian, one for Spanish, and one for German. When the user clicks any of these buttons, the translated phrase will appear in a Label control.

**Step 1:** Start Visual Studio (or Visual Studio Express) and begin a new Windows Forms Application project named *Language Translator*.

**Step 2:** Set up the application's form as shown in Figure 2-59. Notice that the form's Text property is set to *Language Translator*. The form has two Label controls and three Button controls. The names of the controls are shown in the figure. As you place each of the controls on the form, refer to Table 2-3 for the relevant property settings.

**Figure 2-59** The *Language Translator* form



**Step 3:** Once you have the form and its controls set up, you can create the Click event handlers for the Button controls. In the *Designer*, double-click the `italianButton` control. This will open the code editor, and you will see an empty event handler named `italianButton_Click`. Write the following statement inside the event handler:

```
translationLabel.Text = "Buongiorno";
```

**Table 2-3** Control property settings

Control Name	Control Type	Property Settings
instructionLabel	Label	<b>Text:</b> <i>Select a language and I will say Good Morning.</i>
translationLabel	Label	<b>AutoSize:</b> False <b>BorderStyle:</b> FixedSingle <b>Font:</b> Microsoft Sans Serif (Style: Bold, Size: 10 point) <b>Text:</b> (The contents of the Text property have been erased.) <b>TextAlign:</b> MiddleCenter
italianButton	Button	<b>Text:</b> <i>Italian</i>
spanishButton	Button	<b>Text:</b> <i>Spanish</i>
germanButton	Button	<b>Text:</b> <i>German</i>

**Step 4:** Switch your view back to the *Designer* and double-click the `spanishButton` control. In the code editor you will see an empty event handler named `spanishButton_Click`. Write the following statement inside the event handler:

```
translationLabel.Text = "Buenos Dias";
```

**Step 5:** Switch your view back to the *Designer* and double-click the `germanButton` control. In the code editor you will see an empty event handler named `germanButton_Click`. Write the following statement inside the event handler:

```
translationLabel.Text = "Guten Morgen";
```

**Step 6:** The form's code should now appear as shown in Program 2-1. Note that the line numbers are not part of the code. The line numbers are shown so that you and your instructor can more easily refer to different parts of the program. The lines that appear in boldface are the ones that you typed. Make sure the code you typed appears exactly as shown here. (Don't forget the semicolons!)

**Program 2-1** Completed Form1 code for the *Language Translator* application

```

1 using System;
2 using System.Collections.Generic;
3 using System.ComponentModel;
4 using System.Data;
5 using System.Drawing;
6 using System.Linq;
7 using System.Text;
8 using System.Threading.Tasks;
9 using System.Windows.Forms;
10
11 namespace Language_Translator
12 {
13     public partial class Form1 : Form
14     {
15         public Form1()
16         {
17             InitializeComponent();
18         }

```

```

19
20 private void italianButton_Click(object sender, EventArgs e)
21 {
22     translationLabel.Text = "Buongiorno";
23 }
24
25 private void spanishButton_Click(object sender, EventArgs e)
26 {
27     translationLabel.Text = "Buenos Dias";
28 }
29
30 private void germanButton_Click(object sender, EventArgs e)
31 {
32     translationLabel.Text = "Guten Morgen";
33 }
34 }
35 }

```

**Step 7:** Save the project. Then, press the **F5** key on the keyboard or click the *Start Debugging* button (🐞) on the toolbar to compile and run the application.



**NOTE:** If you typed the statements correctly inside the event handlers, the application should run. If you did not type the statements correctly inside the event handlers, a window will appear reporting build errors. If that happens, click the *No* button in the window and then correct the code so it appears exactly as previously shown.

Figure 2-60 shows the application's form when it starts running and after you have clicked each of the Button controls. After you have tested each button, close the application's form.

**Figure 2-60** The *Language Translator* application running



## Checkpoint

- 2.29 In which group of the *Toolbox* can you find the Label control tool?
- 2.30 Once you have placed a Label control on a form, which property do you use to set the text that you want to display?
- 2.31 What property can you use to change the appearance of a Label control's text?
- 2.32 What is the default value of a label's *BorderStyle* property?
- 2.33 How do you change the *BorderStyle* property of a control in the *Properties* window?
- 2.34 What property determines whether a label can be resized?
- 2.35 What property determines the way text is aligned in a Label control?
- 2.36 How can you use a Label control to display output while a program is running?
- 2.37 What happens if you assign an empty string to a control's *Text* property in code?

## 2.6 Making Sense of IntelliSense

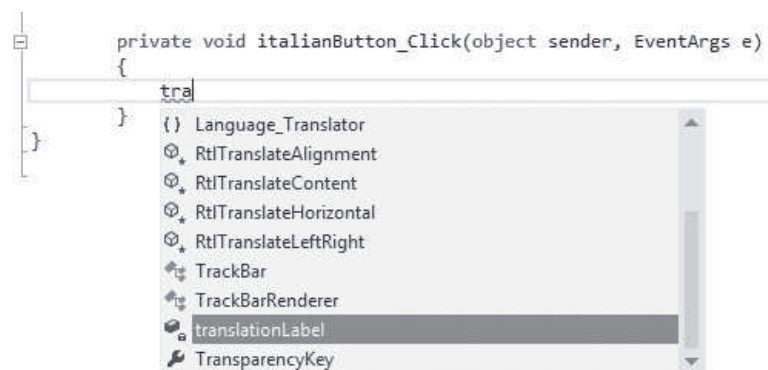
**CONCEPT:** As you type code in the Visual Studio code editor, IntelliSense boxes pop up to assist you. You can use the IntelliSense boxes to automatically complete some programming statements after typing only the first few characters.

**IntelliSense** is a feature of Visual Studio that provides automatic code completion as you write programming statements. Once you learn how to use IntelliSense, it helps you write code faster. If you've worked through the previous tutorials in this chapter, you've already encountered IntelliSense. For example, in Step 3 of Tutorial 2-3, you were instructed to write the following statement in the `italianButton_Click` event handler:

```
translationLabel.Text = "Buongiorno";
```

Did you notice that as soon as you started typing the statement, a box popped up on the screen? This is known as an IntelliSense list box. The contents of the list box changes as you type. Figure 2-61 shows the IntelliSense list box after you have typed the characters `tra`.

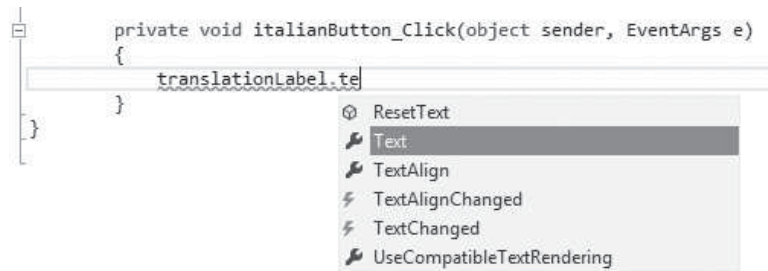
**Figure 2-61** IntelliSense list box displayed



The IntelliSense system is anticipating what you are about to type, and as you type characters, the content of the list box is reduced. The list box shown in Figure 2-61 shows all the names starting with `tra` that might be a candidate for the statement you are typing. Notice that `translationLabel` is selected in the list box. With that item selected, you can press the `[Tab]` key on the keyboard, and the `tra` that you previously typed becomes `translationLabel`.

Next, when you type a period, an IntelliSense list pops up showing every property and method belonging to the `translationLabel` control. Type `te` and the `Text` property becomes selected, as shown in Figure 2-62. When you press the `[Tab]` key to select the `Text` property, your statement automatically becomes `translationLabel.Text`. At this point, you can continue typing until you have completed the statement.

**Figure 2-62** IntelliSense list box after typing “.te”



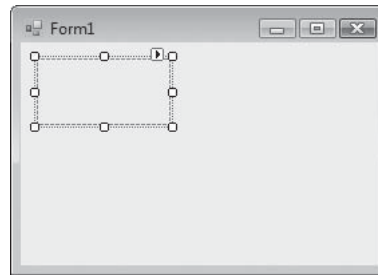
Now that you have an idea of how IntelliSense works, you are encouraged to experiment with it as you write code in future projects. With a little practice, it will become intuitive.

## 2.7 PictureBox Controls

**CONCEPT:** A `PictureBox` control displays a graphic image on a form. `PictureBox` controls have properties for controlling the way the image is displayed. A `PictureBox` control can have a `Click` event handler that responds when the user clicks the control at run time.

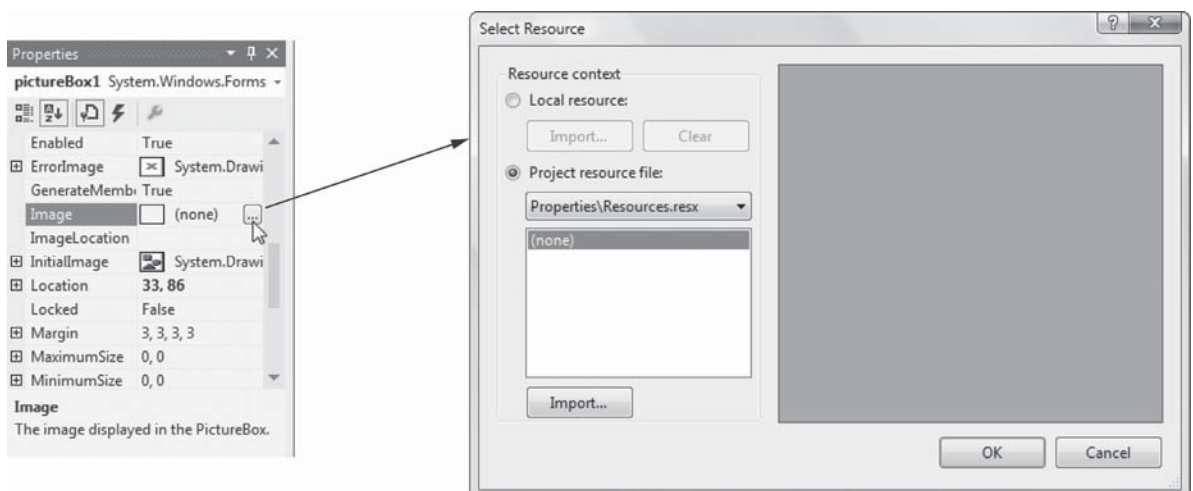
You can use a **PictureBox control** to display a graphic image on a form. A `PictureBox` control can display images that have been saved in the bitmap, GIF, JPEG, metafile, or icon graphics formats.

In the *Toolbox*, the `PictureBox` tool is located in the *Common Controls* group. When you double-click the tool, an empty `PictureBox` control is created on the form, as shown in Figure 2-63. Although the control does not yet display an image, it has a bounding box that shows its size and location, as well as sizing handles. When you create `PictureBox` controls, they are automatically given default names such as `pictureBox1`, `pictureBox2`, and so forth. You should always change the default name to something more meaningful.

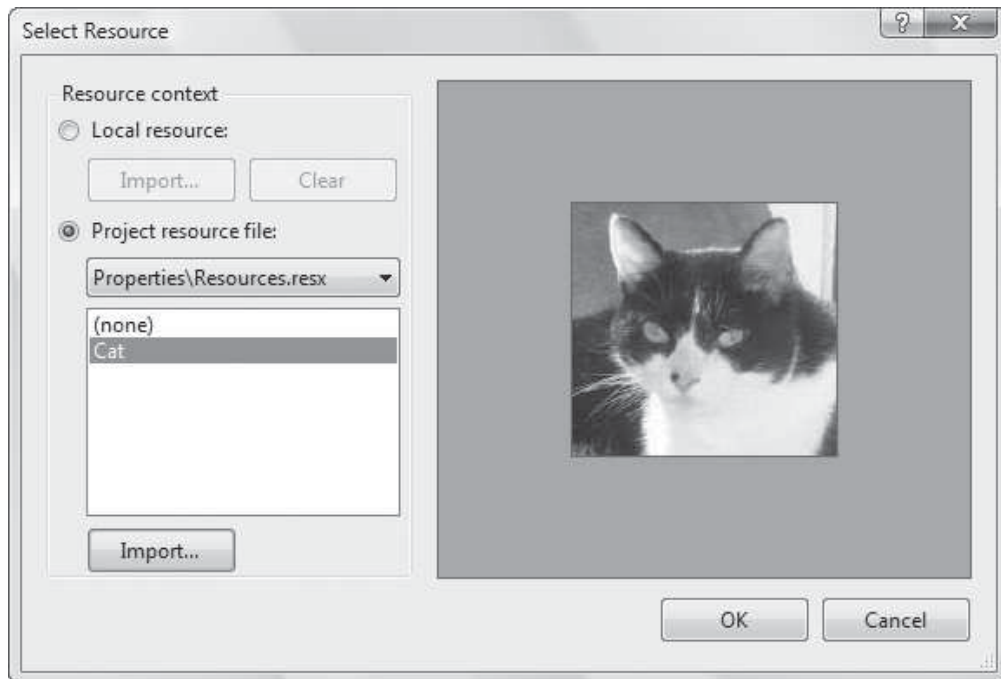
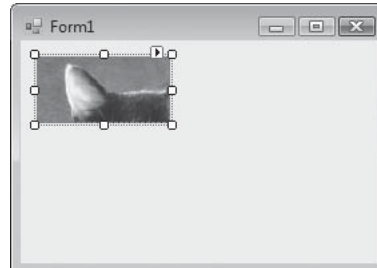
**Figure 2-63** An empty PictureBox control

Once you have created a PictureBox control, you use its **Image** property to specify the image that it will display. Follow these steps:

- Step 1:** Click the Image property in the *Properties* window. An ellipses button (⋮) will appear, as shown on the left in Figure 2-64.
- Step 2:** Click the ellipses button and the *Select Resource* window, shown on the right in Figure 2-64, will appear.

**Figure 2-64** The Image property's *Select Resource* window

- Step 3:** In the *Select Resource* window, click the *Import* button. An *Open* dialog box will appear. Use the dialog box to locate and select the image file that you want to display.
- Step 4:** After you select an image file, you will see its contents displayed in the *Select Resource* window. This indicates that the image has been imported into the project. Figure 2-65 shows an example of the *Select Resource* window after we have selected and imported an image.
- Step 5:** Click the OK button in the *Select Resource* window, and the selected image will appear in the PictureBox control. Figure 2-66 shows an example. Depending on the size of the image, you might see only part of it displayed. This is the case in Figure 2-66 because the image is larger than the PictureBox control. Your next step is to set the *SizeMode* property and adjust the size of the control.

**Figure 2-65** An image selected and imported**Figure 2-66** The image displayed in the PictureBox control

## The SizeMode Property

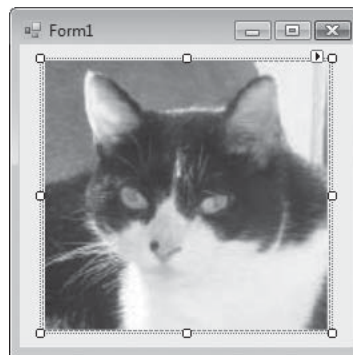
The PictureBox control's **SizeMode** property specifies how the control's image is to be displayed. It can be set to one of the following values:

- **Normal**  
Normal is the default value. The image will be positioned in the upper-left corner of the PictureBox control. If the image is too big to fit in the PictureBox control, it will be clipped.
- **StretchImage**  
StretchImage resizes the image both horizontally and vertically to fit in the PictureBox control. If the image is resized more in one direction than the other, it will appear stretched.
- **AutoSize**  
With AutoSize, the PictureBox control is automatically resized to fit the size of the image.

- **CenterImage**  
CenterImage centers the image in the PictureBox control without resizing it.
- **Zoom**  
Zoom uniformly resizes the image to fit in the PictureBox without losing its original aspect ratio. (**Aspect ratio** is the image's width to height ratio.) This causes the image to be resized without appearing stretched.

Figure 2-67 shows an example of an image displayed in a PictureBox control. The control's `SizeMode` is set to `Zoom`, so it can be resized without appearing stretched.

**Figure 2-67** An image resized with `SizeMode` set to `Zoom`



**NOTE:** PictureBox controls also have a `BorderStyle` property that works just like a Label control's `BorderStyle` property.

## Creating Clickable Images

Buttons aren't the only controls that can respond to Click events. PictureBox controls can, too. That means an application can display an image and perform some action when the user clicks the image.

To make an image clickable, you simply have to create a Click event handler for the PictureBox control that displays the image. You create a Click event handler for a PictureBox control in the same way that you create a Click event handler for a Button control:

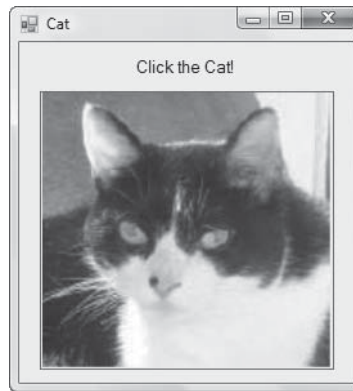
- You double-click the PictureBox control in the *Designer*. This creates an empty Click event handler in the form's source code file.
- In the code editor you write statements inside the event handler that you want to execute when the image is clicked.

As an example, look at the *Cat* project that is in the *Chap02* folder of the Student Sample Programs that accompany this textbook. Figure 2-68 shows the application's form. The PictureBox control's name is `catPictureBox`. Its image is the *Cat.jpg* file, which is also found in the *Chap02* folder of the Student Sample Programs. The `SizeMode` property is set to `Zoom`, and the `BorderStyle` property is set to `FixedSingle`.

Open the `Form1.cs` file in the code editor and you will see that we have already created a Click event handler for the `catPictureBox` control, as shown in Figure 2-69. If you run the application and click the PictureBox, a message box will appear displaying the string *Meow*.



**Figure 2-68** The Cat form



**Figure 2-69** Code for the *Cat* project's Form1.cs file

```

using System;
using System.Collections.Generic;
using System.ComponentModel;
using System.Data;
using System.Drawing;
using System.Linq;
using System.Text;
using System.Threading.Tasks;
using System.Windows.Forms;

namespace Cat
{
    public partial class Form1 : Form
    {
        public Form1()
        {
            InitializeComponent();
        }

        private void catPictureBox_Click(object sender, EventArgs e)
        {
            MessageBox.Show("Meow");
        }
    }
}

```

Click event handler for the catPictureBox control

Tutorial 2-4 gives you a chance to practice using PictureBox controls. In the tutorial, you will create an application with three clickable PictureBox controls, displaying images that are provided in the Student Sample Program files that accompany this book.



**Tutorial 2-4:**  
Creating the *Flags* Application

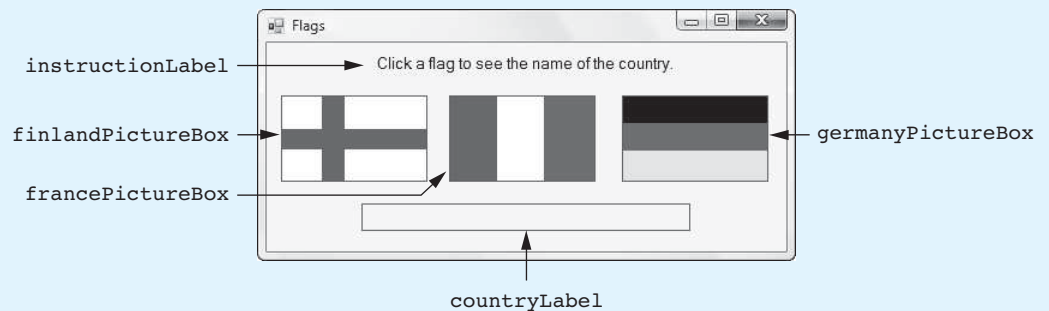
### Tutorial 2-4: Creating the *Flags* Application

In this tutorial you will create an application that displays the flags of Finland, France, and Germany in PictureBox controls. When the user clicks any of these PictureBoxes, the name of that flag's country will appear in a Label control.

**Step 1:** Start Visual Studio (or Visual Studio Express) and begin a new Windows Forms Application project named *Flags*.

**Step 2:** Set up the application's form as shown in Figure 2-70. Notice that the form's Text property is set to *Flags*. The names of the controls are shown in the figure. Refer to Table 2-4 for each control's relevant property settings.

**Figure 2-70** The Flags form



**Table 2-4** Control property settings

Control Name	Control Type	Property Settings
instructionLabel	Label	<b>Text:</b> <i>Click a flag to see the name of the country.</i>
finlandPictureBox	PictureBox	<b>Image:</b> Select and import the Finland.bmp file from the <i>Chap02</i> folder of the Student Sample Programs. <b>BorderStyle:</b> FixedSingle <b>SizeMode:</b> AutoSize
francePictureBox	PictureBox	<b>Image:</b> Select and import the France.bmp file from the <i>Chap02</i> folder of the Student Sample Programs. <b>BorderStyle:</b> FixedSingle <b>SizeMode:</b> AutoSize
germanyPictureBox	PictureBox	<b>Image:</b> Select and import the Germany.bmp file from the <i>Chap02</i> folder of the Student Sample Programs. <b>BorderStyle:</b> FixedSingle <b>SizeMode:</b> AutoSize
countryLabel	Label	<b>AutoSize:</b> False <b>BorderStyle:</b> FixedSingle <b>Font:</b> Microsoft Sans Serif (Style: Bold, Size: 10 point) <b>Text:</b> (The contents of the Text property have been erased.) <b>TextAlign:</b> MiddleCenter

**Step 3:** Once you have the form and its controls set up, you can create the Click event handlers for the PictureBox controls. In the *Designer*, double-click the `finlandPictureBox` control. This will open the code editor, and you will see an empty event handler named `finlandPictureBox_Click`. Write the following statement inside the event handler:

```
countryLabel.Text = "Finland";
```

**Step 4:** Switch your view back to the *Designer* and double-click the `francePictureBox` control. This will open the code editor, and you will see an empty event handler named `francePictureBox_Click`. Write the following statement inside the event handler:

```
countryLabel.Text = "France";
```

**Step 5:** Switch your view back to the *Designer* and double-click the `germanyPictureBox` control. This will open the code editor, and you will see an empty event handler named `germanyPictureBox_Click`. Write the following statement inside the event handler:

```
countryLabel.Text = "Germany";
```

**Step 6:** The form's code should now appear as shown in Program 2-2. As was mentioned in the previous tutorial, the line numbers are shown for reference only, and are not part of the code. The lines that appear in boldface are the ones that you typed. Make sure the code you typed appears exactly as shown here. (Don't forget the semicolons!)

---


#### Program 2-2 Completed Form1 code for the *Flags* application

```

1 using System;
2 using System.Collections.Generic;
3 using System.ComponentModel;
4 using System.Data;
5 using System.Drawing;
6 using System.Linq;
7 using System.Text;
8 using System.Threading.Tasks;
9 using System.Windows.Forms;
10
11 namespace Flags
12 {
13     public partial class Form1 : Form
14     {
15         public Form1()
16         {
17             InitializeComponent();
18         }
19
20         private void finlandPictureBox_Click(object sender, EventArgs e)
21         {
22             countryLabel.Text = "Finland";
23         }
24
25         private void francePictureBox_Click(object sender, EventArgs e)
26         {
27             countryLabel.Text = "France";
28         }
29
30         private void germanyPictureBox_Click(object sender, EventArgs e)
31         {
32             countryLabel.Text = "Germany";
33         }
34     }
35 }

```

---

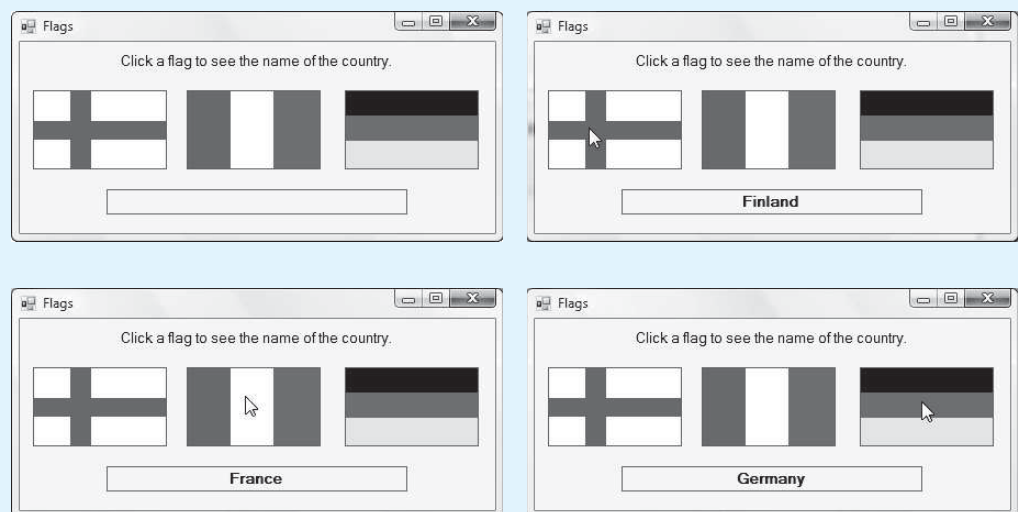
**Step 7:** Save the project. Then, press the **(F5)** key on the keyboard, or click the *Start Debugging* button (  ) on the toolbar to compile and run the application.



**NOTE:** If you typed the statements correctly inside the event handlers, the application should run. If you did not type the statements inside the event handlers correctly, a window will appear reporting build errors. If that happens, click the *No* button in the window, then correct the code so it appears exactly as previously shown.

Figure 2-71 shows the application's form when it starts running and then after you have clicked each of the PictureBox controls. After you have clicked each flag to make sure the application works correctly, close the form.

**Figure 2-71** The *Flags* application running



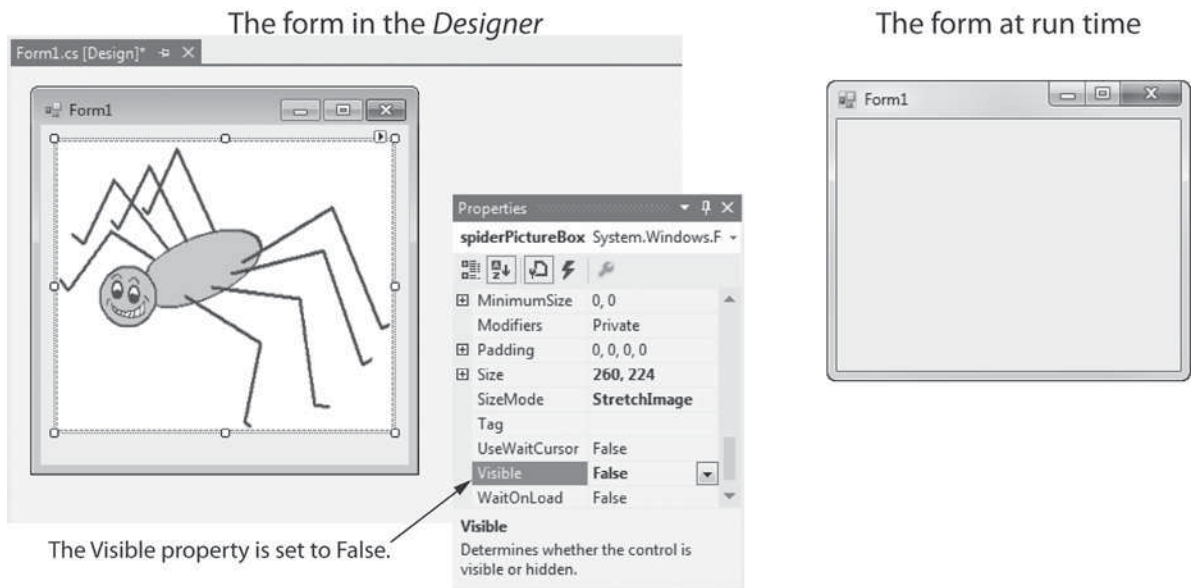
## The Visible Property

Most controls have a **Visible property** that determines whether the control is visible on the form at run time. The Visible property is a Boolean property, which means it can be set only to the values `True` or `False`. If a control's Visible property is set to `True`, the control will be visible on the form at run time. If a control's Visible property is set to `False`, however, the control will not be visible at run time. By default, the Visible property is set to `True`.

When you use the *Properties* window to change a control's Visible property at design time, the control will still be visible in the *Designer*. When you run the application, however, the control will not be visible on the form. For example, the image on the left in Figure 2-72 shows a form in the *Designer*. The PictureBox control's Visible property is set to `False`, but the control can still be seen in the *Designer*. The image on the right shows the form while the application is running. At run time, the control is not visible.

A control's Visible property can also be modified in code by an assignment statement, which makes it possible to hide or display a control while the application is running. For example, the PictureBox control shown in Figure 2-72 is named `spiderPictureBox`. The following statement sets the control's Visible property to `true`:

```
spiderPictureBox.Visible = true;
```

**Figure 2-72** A PictureBox control with its Visible property set to False

When this statement executes, the `spiderPictureBox` control will become visible. Likewise, the following statement sets the control's `Visible` property to `false`:

```
spiderPictureBox.Visible = false;
```

When this statement executes, the `spiderPictureBox` control will become invisible.



**NOTE:** When you write the values `true` and `false` in code, as shown in the previous assignment statement, they must be written in all lowercase letters. The words `true` and `false` are C# keywords, and an error will occur if you don't write them in lowercase. However, when you use the *Properties* window to set a Boolean property, such as `Visible`, the values `True` and `False` will be shown with an initial capital. Try not to let this inconsistency confuse you!

In Tutorial 2-5 you will create an application that uses the `Visible` property of two `PictureBox` controls to simulate a card being flipped over.



VideoNote

**Tutorial 2-5:**  
Creating the  
*Card Flip*  
Application



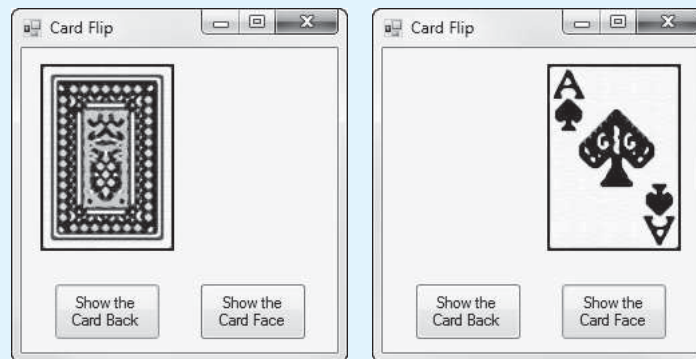
### **Tutorial 2-5:** Creating the *Card Flip* Application

In this tutorial you will create an application that simulates a card being flipped over. When the application runs, it will display the form shown on the left in Figure 2-73. The form initially displays the back of a poker card. When the user clicks the *Show the Card Face* button, the card will be flipped over to show its face, as shown in the form on the right. When the user clicks the *Show the Card Back* button, the card is flipped back over to show its back.

The simulation of the card being flipped will be accomplished using the following logic:

- When the user clicks the *Show the Card Face* button, the PictureBox showing the card's back will be made invisible and the PictureBox showing the card's face will be made visible.
- When the user clicks the *Show the Card Back* button, the PictureBox showing the card's face will be made invisible and the PictureBox showing the card's back will be made visible.

**Figure 2-73** The *Card Flip* application



**Step 1:** Start Visual Studio (or Visual Studio Express) and begin a new Windows Forms Application project named *Card Flip*.

**Step 2:** Set up the application's form as shown in Figure 2-74. Notice that the form's Text property is set to *Card Flip*. The names of the controls are shown in the figure. Use the *Properties* window to make the property settings shown in Table 2-5. (In particular, note that the *cardBackPictureBox* control's Visible property is set to True, and the *cardFacePictureBox* control's Visible property is set to False.)

**Figure 2-74** The *Card Flip* form



**Table 2-5** Control property settings

Control Name	Control Type	Property Settings
cardBackPictureBox	PictureBox	<b>Image:</b> Select and import the Backface_Blue.jpg file from the <i>Chap02</i> folder of the Student Sample Programs. <b>Size:</b> 100, 140 <b>SizeMode:</b> Zoom <b>Visible:</b> True
cardFacePictureBox	PictureBox	<b>Image:</b> Select and import the Ace_Spades.jpg file from the <i>Chap02</i> folder of the Student Sample Programs. <b>Size:</b> 100, 140 <b>SizeMode:</b> Zoom <b>Visible:</b> False
showBackButton	Button	<b>Text:</b> <i>Show the Card Back</i> (Manually resize the button to accommodate the text, as shown in Figure 2-74.)
showFaceButton	Button	<b>Text:</b> <i>Show the Card Face</i> (Manually resize the button to accommodate the text, as shown in Figure 2-74.)

**Step 3:** Once you have the form and its controls set up, you can create the Click event handlers for the Button controls. In the *Designer*, double-click the `showBackButton` control. This will open the code editor, and you will see an empty event handler named `showBackButton_Click`. Write the following statements inside the event handler:

```
cardBackPictureBox.Visible = true;
cardFacePictureBox.Visible = false;
```

**Step 4:** Switch your view back to the *Designer* and double-click the `showFaceButton` control. This will open the code editor, and you will see an empty event handler named `showFaceButton_Click`. Write the following statements inside the event handler:

```
cardBackPictureBox.Visible = false;
cardFacePictureBox.Visible = true;
```

**Step 5:** The form's code should now appear as shown in Program 2-3. Remember, the line numbers are shown for reference only and are not part of the code. The lines that appear in boldface are the ones that you typed. Make sure the code you typed appears exactly as shown here. (Don't forget the semicolons!)

---


#### **Program 2-3** Completed Form1 code for the *Card Flip* application

```
1 using System;
2 using System.Collections.Generic;
3 using System.ComponentModel;
4 using System.Data;
5 using System.Drawing;
6 using System.Linq;
7 using System.Text;
8 using System.Threading.Tasks;
```

```

9 using System.Windows.Forms;
10
11 namespace Card_Flip
12 {
13     public partial class Form1 : Form
14     {
15         public Form1()
16         {
17             InitializeComponent();
18         }
19
20         private void showBackButton_Click(object sender, EventArgs e)
21         {
22             cardBackPictureBox.Visible = true;
23             cardFacePictureBox.Visible = false;
24         }
25
26         private void showFaceButton_Click(object sender, EventArgs e)
27         {
28             cardBackPictureBox.Visible = false;
29             cardFacePictureBox.Visible = true;
30         }
31     }
32 }

```

**Step 6:** Save the project. Then, press the **[F5]** key on the keyboard, or click the *Start Debugging* button () on the toolbar to compile and run the application.

Test the application by clicking the buttons. When you click the *Show the Card Face* button you should see the card's face (and the back of the card should be invisible). When you click the *Show the Card Back* button you should see the card's back (and the card's face should be invisible). When you are finished, close the application.



**NOTE:** If you typed the statements correctly inside the event handlers, the application should run. If you did not type the statements inside the event handlers correctly, a window will appear reporting build errors. If that happens, click the *No* button in the window and then correct the code so it appears exactly as previously shown.



**NOTE:** In addition to PictureBoxes, many other types of controls have a *Visible* property. For example, you can make a *Label* control visible or invisible by setting the value of its *Visible* property.

## Sequential Execution of Statements

In Tutorial 2-5, the event handlers that you created each contained more than one statement. For example, here is the `showBackButton_Click` method:

```

private void showBackButton_Click(object sender, EventArgs e)
{
    cardBackPictureBox.Visible = true;
    cardFacePictureBox.Visible = false;
}

```



This method has two assignment statements. When the method executes, the statements in the method execute in the order that they appear, from the beginning of the method to the end of the method. This statement executes first:

```
cardBackPictureBox.Visible = true;
```

Then this statement executes:

```
cardFacePictureBox.Visible = false;
```

When the application is running, however, you can't really tell that the statements are executing in this order simply by watching the action take place on the screen. When you click the `showBackButton` control, the Click event handler executes so quickly that it appears as though both statements execute simultaneously. It's important for you to understand, however, that the statements execute one at a time, in the order that they appear in the method.

In this particular method, it doesn't really matter which assignment statement is written first. If we reverse the order of the statements, we will not be able to see the difference on the screen because the application executes so quickly. In most applications, however, the order in which you write the statements in the event handlers is critically important. In Chapter 3 you will start writing event handlers that perform several steps, and in most cases, the steps must be performed in a specific order. Otherwise, the program will not produce the correct results.



## Checkpoint

- 2.38 What is a PictureBox control used for?
- 2.39 Where is the PictureBox tool located in the *Toolbox*?
- 2.40 How do you display an image in the PictureBox?
- 2.41 What is the default value of the PictureBox control's `SizeMode` property?
- 2.42 How does setting the `SizeMode` property to `Zoom` affect the image that is to be displayed in the PictureBox control?
- 2.43 How do you create a clickable image?
- 2.44 Does the value of a control's `Visible` property change how the image appears at run time and design time?

## 2.8

## Comments, Blank Lines, and Indentation

**CONCEPT:** Comments are brief notes that are placed in a program's source code to explain how parts of the program work. Programmers commonly use blank lines and indentation in program code to give the code visual organization and make it easier to read.

### Comments

Comments are short notes that are placed in different parts of a program, explaining how those parts of the program work. Comments are not intended for the compiler. They are intended for any person who is reading the code and trying to understand what it does.

In C# there are three types of comments: line comments, block comments, and documentation comments. A **line comment** appears on one line in a program. You begin a line

comment with two forward slashes (`//`). Everything written after the slashes, to the end of the line, is ignored by the compiler. The following code sample shows how we might use line comments in the `showBackButton_Click` event handler from Tutorial 2-5. Each line comment explains what the very next line of code does.

```
private void showBackButton_Click(object sender, EventArgs e)
{
    // Make the image of the back of the card visible.
    cardBackPictureBox.Visible = true;
    // Make the image of the face of the card invisible.
    cardFacePictureBox.Visible = false;
}
```

A line comment does not have to occupy an entire line. Anything appearing after the `//` symbol, to the end of the line, is ignored. So, a comment can appear after an executable statement. The following code sample shows an example.

```
private void showBackButton_Click(object sender, EventArgs e)
{
    cardBackPictureBox.Visible = true; // Show the card back.
    cardFacePictureBox.Visible = false; // Hide the card face.
}
```

A **block comment** can occupy multiple consecutive lines in a program. A block comment starts with `/*` (a forward slash followed by an asterisk) and ends with `*/` (an asterisk followed by a forward slash). Everything between these markers is ignored. The following code sample shows how block comments may be used.

```
/* Click event handler for the showBackButton control.
   This method makes the image of the back of the card
   visible and makes the image of the card's face
   invisible.
*/
private void showBackButton_Click(object sender, EventArgs e)
{
    cardBackPictureBox.Visible = true; // Show the card back.
    cardFacePictureBox.Visible = false; // Hide the card face.
}
```

The first five lines in this code sample are a block comment that explains what the `showBackButton_Click` method does. Block comments make it easier to write long explanations because you do not have to mark every line with a comment symbol.

Remember the following advice when using block comments:

- Be careful not to reverse the beginning symbol (`/*`) with the ending symbol (`*/`).
- Do not forget the ending symbol.

Each of these mistakes can be difficult to track down and will prevent the program from compiling correctly.

The third type of comment is known as a documentation comment. **Documentation comments** are used by professional programmers to embed extensive documentation in a program's source code. Visual Studio can extract information from the documentation comments and generate external documentation files. Single-line documentation comments begin with three forward slashes (`///`). Block documentation comments begin with `/**` and end with `*/`. Although documentation comments are useful for professional programmers, we do not use them in this book.

As a beginning programmer, you might resist the idea of writing a lot of comments in your programs. After all, it's a lot more interesting to write code that actually does something. However, it's crucial that you take the extra time to write comments. They

will almost certainly save you time in the future when you have to modify or debug the program. Even large and complex programs can be made easy to read and understand if they have proper comments.

## Using Blank Lines and Indentation to Make Your Code Easier to Read

Programmers commonly use blank lines and indentations in their code to create a sense of visual organization. This is similar to the way that authors visually arrange the text on the pages of a book. Instead of writing each chapter as one long series of sentences, they break the text into paragraphs that are visually separated on the page. This does not change the information in the book, but it makes it easier to read.

For example, in the following code sample, we have inserted a blank line inside the method to visually separate the code into two sets of statements. The blank line is not required, but it makes the code easier for humans to read.

```
private void showBackButton_Click(object sender, EventArgs e)
{
    // Make the image of the back of the card visible.
    cardBackPictureBox.Visible = true;
    // Make the image of the face of the card invisible.
    cardFacePictureBox.Visible = false;
}
```

Programmers also use indentation to visually organize code. You may have noticed that in the code editor, all the statements that appear inside a set of braces (`{}`) are indented. For example, all the statements inside a namespace are indented, all the statements inside a class are indented, and all the statements inside a method are indented. In fact, Visual Studio is normally set up to automatically indent the code that you write in this fashion.

Although the indentation is not required, it makes your code much easier to read. By indenting the statements inside a method, you visually set them apart. As a result, you can tell at a glance which statements are inside the method. The same is true for classes and namespaces. This practice of indentation is a convention that virtually all programmers follow.



### Checkpoint

- 2.45 What purpose do comments serve?
- 2.46 How are line comments and block comments different?
- 2.47 What should you be careful to remember about the beginning and ending symbols of block comments?
- 2.48 Why do programmers insert blank lines and indentations in their code?

## 2.9

## Writing the Code to Close an Application's Form

**CONCEPT:** To close an application's form in code, you use the statement `this.Close();`

All the applications that you created in this chapter's tutorials required the user to click the standard Windows close button (✕) to close the application. The standard Windows close button appears in the upper-right corner of almost every window. In many

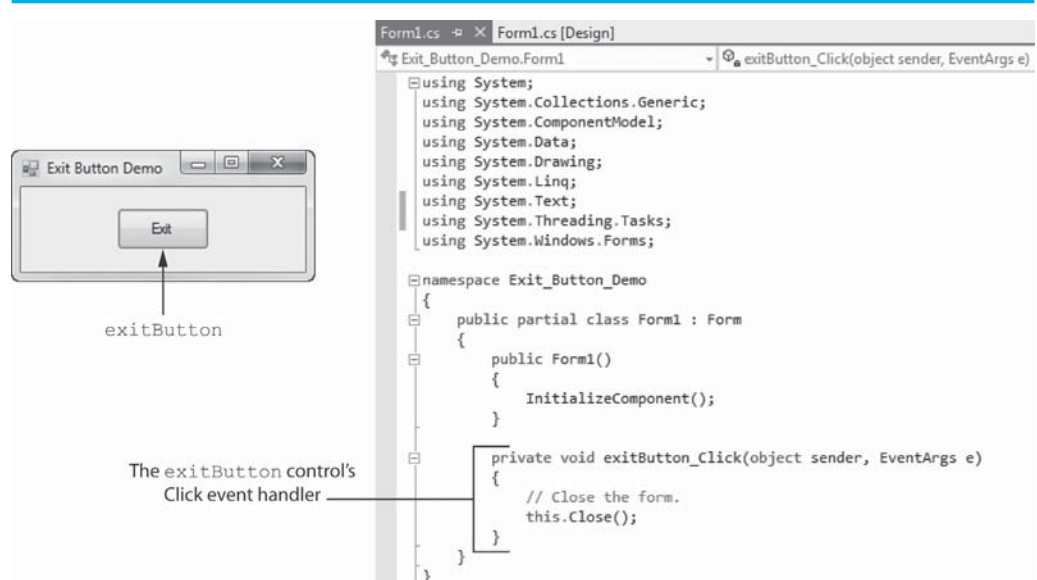
applications, however, you will want to give the user an alternative way to close the application. For example, you might want to create an *Exit* button that closes the application when it is clicked.

To close an application's form, you execute the following statement:

```
this.Close();
```

Let's look at an example of how this statement can be used. Figure 2-75 shows the form and code from a project named *Exit Button Demo*. The Button control that you see on the form is named `exitButton`. In the form's code you can see that we have created a Click event handler for the button. When the user clicks the button, it closes the form, thus closing the application.

**Figure 2-75** A form with an *Exit* button



## 2.10 Dealing with Syntax Errors

**CONCEPT:** The Visual Studio code editor examines each statement as you type it and reports any syntax errors that are found. This allows you to quickly correct syntax errors.

Writing code requires a lot of precision. Even small errors, such as using an uppercase letter where you are supposed to use a lowercase letter or forgetting to end a statement with a semicolon, will prevent an application's code from compiling and executing. Recall from Chapter 1 that these types of mistakes are known as syntax errors.

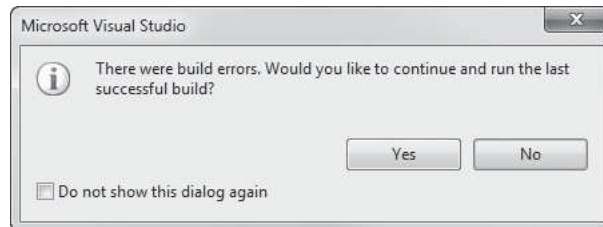
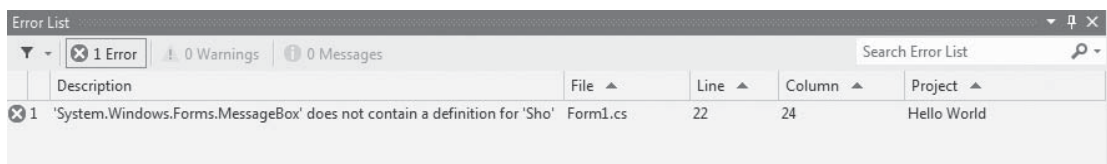
The Visual Studio code editor does a good job of reporting syntax errors soon after you type them. When you enter a statement into the editor, Visual Studio analyzes it, and if a syntax error is found, it is underlined with a jagged line. Figure 2-76 shows an example. If you hold the mouse cursor over the jagged line, a description of the error will pop up in a ToolTip window. The description usually gives you enough information to determine the cause of the error and how to fix it.

**Figure 2-76** Error underlined

```
private void messageButton_Click(object sender, EventArgs e)
{
    MessageBox.Sho("Hello World");
}
```

This jagged line indicates an error.

If a syntax error exists in a project's code and you attempt to compile and execute it (by pressing the **F5** key on the keyboard, or clicking the *Start Debugging* button (▶) on the toolbar), you will see the window shown in Figure 2-77, reporting build errors. Click the *No* button to close the window, and you will see the *Error List* shown in Figure 2-78.

**Figure 2-77** Window reporting build errors**Figure 2-78** *Error List* window

Notice that the *Error List* window shows a description of the error, the source code file that contains the error, the line number and column number of the error, and the name of the project. If you double-click the error message that is displayed in the *Error List* window, the code editor will highlight the code that caused the error.

## Checkpoint

- 2.49 What statement do you use to close an application's form in code?
- 2.50 How can you tell that Visual Studio has found a syntax error?
- 2.51 What happens if you hold the mouse cursor over a jagged line in the code editor?
- 2.52 What happens if you attempt to compile and execute a program that contains syntax errors?

## Key Terms

Alphabetical button	<i>Hello World</i>
aspect ratio	identifiers
assignment operator	Image property
assignment statement	IntelliSense
AutoSize property	Label control
block comment	line comment
Boolean	message box
BorderStyle property	method call
bounding box	namespace
braces	PictureBox control
camelCase	Program.cs file
Categorized button	run time
Click event	semicolon
design time	SizeMode property
dialog box	sizing handles
documentation comments	source code file
event handler	string
Font property	TextAlign property
Form1.cs file	Visible property

## Review Questions

### Multiple Choice

- A(n) \_\_\_\_\_ is the thin dotted line that encloses an object in the *Designer*.
  - selection marker
  - control binder
  - bounding box
  - object container
- The small squares that appear on the right edge, bottom edge, and lower-right corner of a form's bounding box are called \_\_\_\_\_.
  - sizing hooks
  - form edges
  - bounding tags
  - sizing handles
- \_\_\_\_\_ is the name of the blank form that Visual Studio initially creates in a new project.
  - Form1
  - Main
  - New1
  - Blank
- The \_\_\_\_\_ property holds the text that is displayed on the face of the button.
  - Name
  - Text
  - Tag
  - Face
- A file that contains program code is called a(n) \_\_\_\_\_.
  - destination code file
  - executable file

- c. machine language file
  - d. source code file
6. A namespace is container that holds \_\_\_\_\_.
- a. methods
  - b. names
  - c. spaces
  - d. classes
7. A(n) \_\_\_\_\_ is a method that executes when a specific event takes place while an application is running.
- a. action process
  - b. event handler
  - c. runtime procedure
  - d. event method
8. The statement `MessageBox.Show("Hello World");` is an example of a(n) \_\_\_\_\_.
- a. method call
  - b. namespace
  - c. Click event
  - d. event handler
9. In programming we use the term *string* to mean \_\_\_\_\_.
- a. many lines of code
  - b. parallel memory locations
  - c. string of characters
  - d. virtually anything
10. A(n) \_\_\_\_\_ marks the end of a programming statement in C#.
- a. semicolon
  - b. period
  - c. hyphen
  - d. underscore
11. A piece of data that is written into a program's code is a(n) \_\_\_\_\_.
- a. identifier
  - b. specifier
  - c. keyword
  - d. literal
12. The time during which you build the GUI and write the application's code is referred to as \_\_\_\_\_.
- a. run time
  - b. design time
  - c. code time
  - d. planning
13. The time during which an application is executing is referred to as \_\_\_\_\_.
- a. go time
  - b. design time
  - c. execution
  - d. run time
14. When you want to display text on a form, you use a \_\_\_\_\_ control.
- a. Button
  - b. PictureBox

- c. Label
  - d. TextBox
15. The \_\_\_\_\_ property allows you to set the font, font style, and size of the control's text.
- a. Style
  - b. AutoSize
  - c. Text
  - d. Font
16. A \_\_\_\_\_ property can be set to one of two possible values: True or False.
- a. Boolean
  - b. Logical
  - c. Binary
  - d. Dual
17. Label controls have a(n) \_\_\_\_\_ property that controls the way they can be resized.
- a. Stretch
  - b. AutoSize
  - c. Dimension
  - d. Fixed
18. The \_\_\_\_\_ property can be used to change the text's alignment in the label.
- a. TextPosition
  - b. AutoAlign
  - c. TextCenter
  - d. TextAlign
19. In code, you use a(n) \_\_\_\_\_ to store a value in a control's property.
- a. Click event
  - b. method call
  - c. assignment statement
  - d. Boolean value
20. The equal sign (=) is known as the \_\_\_\_\_.
- a. equality symbol
  - b. assignment operator
  - c. equality operator
  - d. property position
21. The standard notation for referring to a control's property in code is \_\_\_\_\_.
- a. *ControlName.PropertyName*
  - b. *ControlName=PropertyName*
  - c. *PropertyName.ControlName*
  - d. *PropertyName=ControlName*
22. \_\_\_\_\_ is a feature of Visual Studio that provides automatic code completion as you write programming statements.
- a. AutoCode
  - b. AutoComplete
  - c. IntelliSense
  - d. IntelliCode
23. You can use a(n) \_\_\_\_\_ control to display a graphic image on a form.
- a. Graphics
  - b. PictureBox



- c. Drawing
  - d. ImageBox
24. Once you have created a PictureBox control, you use its \_\_\_\_\_ property to specify the image that it will display.
- a. Image
  - b. Source
  - c. DrawSource
  - d. ImageList
25. The PictureBox control's \_\_\_\_\_ property specifies how the control's image is to be displayed.
- a. RenderMode
  - b. DrawMode
  - c. SizeMode
  - d. ImageMode
26. \_\_\_\_\_ is the image's width to height ratio.
- a. Aspect ratio
  - b. Size ratio
  - c. Projection ratio
  - d. Area ratio
27. Most controls have a \_\_\_\_\_ property that determines whether the control is visible on the form at run time.
- a. Render
  - b. Viewable
  - c. Visible
  - d. Draw
28. A(an) \_\_\_\_\_ appears on one line in a program.
- a. inline comment
  - b. line comment
  - c. forward comment
  - d. block comment
29. A \_\_\_\_\_ can occupy multiple consecutive lines in a program.
- a. block comment
  - b. square comment
  - c. multiline comment
  - d. machine comment
30. Programmers commonly use blank lines and indentations in their code to create a sense of \_\_\_\_\_.
- a. logic
  - b. visual organization
  - c. documentation
  - d. program flow
31. To close an application's form in code, you use the statement \_\_\_\_\_.
- a. `Close();`
  - b. `Close.This();`
  - c. `Close()`
  - d. `this.Close();`

**True or False**

1. Changing an object's Text property also changes the object's name.
2. When a form is created, its Text property is initially set to the same value as the form's name.
3. The form's title is displayed in the bar along the top of a form.
4. C# source code files always end with the .cs extension.
5. You add your own code to the Program.cs file as you develop an application.
6. C# code is organized as methods, which are contained inside classes, which are contained inside namespaces.
7. In C# code, each opening brace must have a corresponding closing brace at some point later in the program.
8. When you double-click a control in the *Designer*, Visual Studio not only creates an empty event handler, but it also writes some code that you don't see, elsewhere in the project that is necessary for the event handler to properly function.
9. A Label control's Text property is initially set to the same value as the Label control's name.
10. When a Label control's AutoSize property is set to True, you cannot manually change the size of the control by clicking and dragging its bounding box.
11. By default, a label's text is aligned with the bottom and right edges of the label's bounding box.
12. Label controls are useful for displaying output while an application is running.
13. The assignment operator assigns the value that appears on its left side to the item that appears on its right side.
14. PictureBox controls also have a BorderStyle property that works just like a Label control's BorderStyle property.
15. Buttons are the only controls that can respond to Click events.
16. The Visible property is a Binary property, which means it can be set only to the values 1 and 0.
17. When you write the values true or false in code, they must be written in all lowercase letters.
18. In C# there are three types of comments: line comments, block comments, and documentation comments.
19. To close an application's form in code, you use the statement `Close.This();`
20. The Visual Studio code editor examines each statement as you type it, and reports any syntax errors that are found.

**Short Answer**

1. What does a bounding box indicate about an object in the *Designer*?
2. What happens when you position the mouse cursor over an edge or corner of a bounding box that has sizing handles?
3. What determines an object's appearance and other characteristics?

4. What is shown by each column in the *Properties* window?
5. What steps must you perform to change a form's Text property?
6. What steps must you perform to change a form's Size property in the *Properties* window?
7. How do you move a control to a new location on the form using the mouse?
8. What steps do you perform to change a Button control's Text property?
9. Briefly describe the contents of the Form1.cs file.
10. In code, what characters do you enclose a string literal in?
11. When creating an event handler for a button, is it possible to skip a step by opening the code editor and writing all the event handler code yourself? Why or why not?
12. Briefly describe the difference between design time and run time.
13. Describe the appearance of a Label control that's BorderStyle property is set to Fixed3D.
14. What does it mean when a Label control's AutoSize property is set to True?
15. What are the values that the TextAlign property may be set to?
16. How do you clear the text that is displayed in a Label control in code?
17. What are the different image formats that a PictureBox control can display?
18. List the values that the SizeMode property of a PictureBox control can be set to.
19. What are the three types of comments you can use in Visual C#?
20. How does Visual Studio help you to quickly correct syntax errors?

### Algorithm Workbench

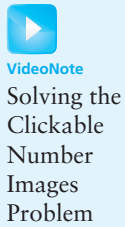
1. What statement would you write to display *Good Afternoon* in a message box?
2. What statement would you write to display your name in a message box?
3. Suppose an application's GUI has a Label control named `dogLabel1`. Write a statement that causes *Fido* to be displayed in the `dogLabel1` control.
4. Suppose an application's GUI has a Label control named `outputLabel1`. Write a statement that clears any text that happens to be displayed by the control.
5. Suppose an application's GUI has a PictureBox control named `myPicture`. Write a statement that makes the control invisible.

## Programming Problems

### 1. Latin Translator

Look at the following list of Latin words and their meanings.

Latin	English
sinister	left
dexter	right
medium	center



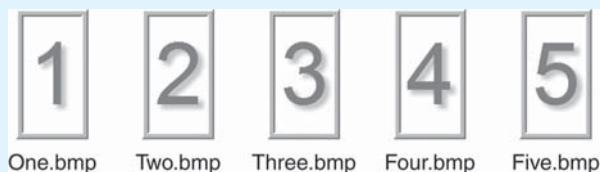
Create an application that translates the Latin words to English. The form should have three buttons, one for each Latin word. When the user clicks a button, the application should display the English translation in a Label control.

2. Clickable Number Images

In the *Chap02* folder, in the Student Sample Program files, you will find the image files shown in Figure 2-79. Create an application that displays these images in PictureBox controls. The application should perform the following actions:

- When the user clicks the 1 image, the application should display the word *One* in a message box.
- When the user clicks the 2 image, the application should display the word *Two* in a message box.
- When the user clicks the 3 image, the application should display the word *Three* in a message box.
- When the user clicks the 4 image, the application should display the word *Four* in a message box.
- When the user clicks the 5 image, the application should display the word *Five* in a message box.

Figure 2-79 Image files



3. Card Identifier

In the Student Sample Programs that accompany this book, you will find a folder named *Images\Cards\Poker Large*. In that folder you will find JPEG image files for a complete deck of poker cards. Create an application with five PictureBox controls. Each PictureBox should display a different card from the set of images. When the user clicks any of the PictureBox controls, the name of the card should be displayed in a Label control. Figure 2-80 shows an example of the application running. The image on the left shows the application’s form when it starts running. The image on the right shows the form after the user has clicked the two of clubs card.

Figure 2-80 Card Identifier application



#### 4. Joke and Punch line

A joke typically has two parts: a setup and a punch line. For example, this might be the setup for a joke:

*How many programmers does it take to change a lightbulb?*

And this is the punch line:

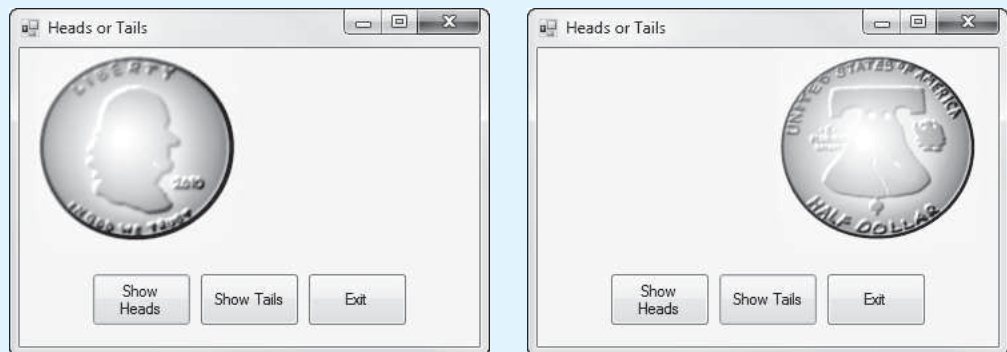
*None. That's a hardware problem.*

Think of your favorite joke and identify its setup and punch line. Then, create an application that has a Label and two buttons on a form. One of the buttons should read “Setup” and the other button should read “Punch line.” When the *Setup* button is clicked, display the joke’s setup in the Label control. When the *Punch line* button is clicked, display the joke’s punch line in the Label control.

#### 5. Heads or Tails

In the Student Sample Programs that accompany this book you will find a folder named *Images\Coins* that contains images showing the heads and tails sides of a coin. Create an application with a *Show Heads* button and a *Show Tails* button. When the user clicks the *Show Heads* button, an image of the heads side of a coin should appear. When the user clicks the *Show Tails* button, an image of the tails side of a coin should appear. Figure 2-81 shows examples of how the application’s form might appear.

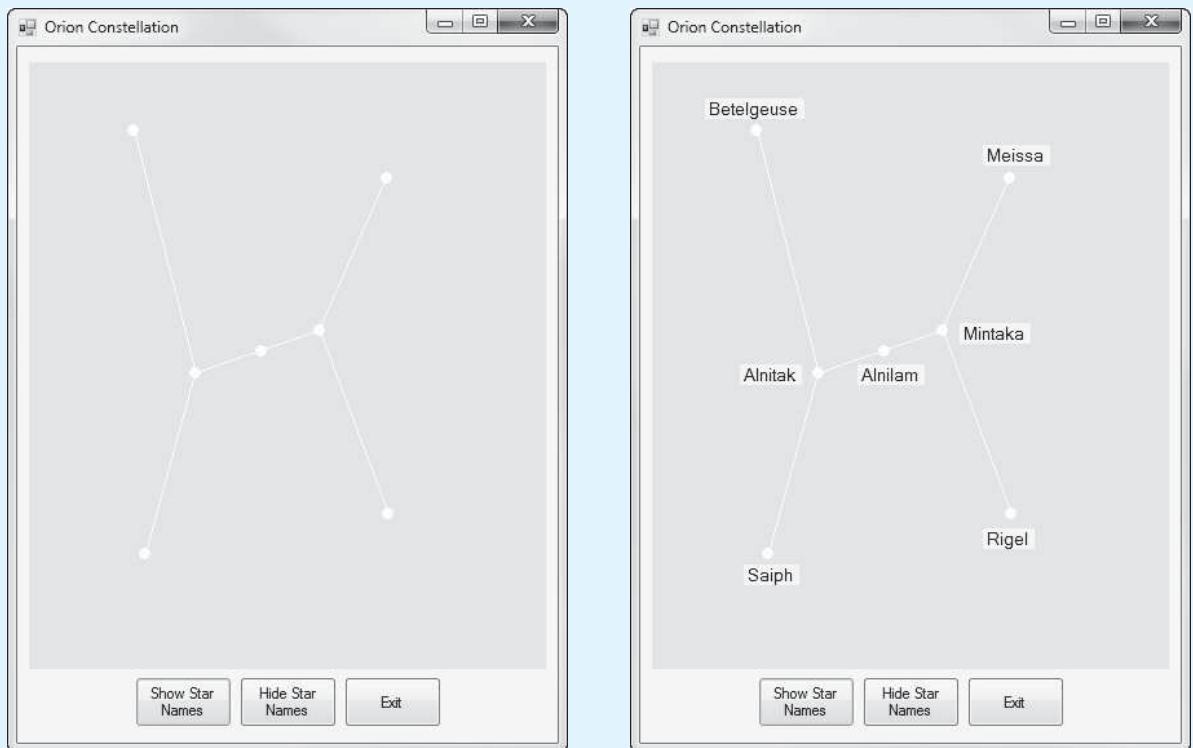
**Figure 2-81** The *Heads or Tails* application



#### 6. Orion Constellation

Orion is one of the most famous constellations in the night sky. In the *Chap02* folder of the Student Sample Programs that accompany this book, you will find an image file named *Orion.bmp*, which contains a diagram of the Orion constellation. Create an application that displays the Orion image in a PictureBox control, as shown on the left in Figure 2-82. The application should have a button that, when clicked, displays the names of each of the stars, as shown on the right in Figure 2-82. The application should have another button that, when clicked, hides the star names. The names of the stars are *Betelgeuse*, *Meissa*, *Alnitak*, *Alnilam*, *Mintaka*, *Saiph*, and *Rigel*.

**Hint:** Place the PictureBox control with the Orion image on the form. Then, place Label controls containing the star names on top of the PictureBox. Use the *Properties* window to set each of the Label control’s *Visible* property to *False*. That will cause the labels to be invisible when the application runs. The *Show Star Names* button will set each of the Label control’s *Visible* property to *true*, and the *Hide Star Names* button will set each of the Label control’s *Visible* property to *false*.

**Figure 2-82** The *Orion Constellation* application

*This page intentionally left blank*

## TOPICS

- |     |  |      |                                   |
|-----|--|------|-----------------------------------|
| 3.1 | Reading Input with TextBox Controls                      | 3.7  | Simple Exception Handling         |
| 3.2 | A First Look at Variables                                | 3.8  | Using Named Constants             |
| 3.3 | Numeric Data Types and Variables                         | 3.9  | Declaring Variables as Fields     |
| 3.4 | Performing Calculations                                  | 3.10 | Using the <code>Math</code> Class |
| 3.5 | Inputting and Outputting Numeric Values                  | 3.11 | More GUI Details                  |
| 3.6 | Formatting Numbers with the <code>ToString</code> Method |      |                                   |

### 3.1 Reading Input with TextBox Controls

**CONCEPT:** The `TextBox` control is a rectangular area that can accept keyboard input from the user.

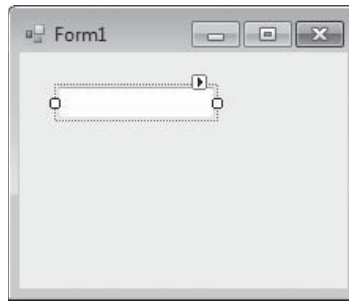
Many of the programs that you will write from this point forward will require the user to enter data. The data entered by the user will then be used in some sort of operation. One of the primary controls that you will use to get data from the user is the `TextBox` control.

A **TextBox control** appears as a rectangular area on a form. When the application is running, the user can type text into a `TextBox` control. The program can then retrieve the text that the user entered and use that text in any necessary operations.

In the *Toolbox*, the `TextBox` tool is located in the *Common Controls* group. When you double-click the tool, a `TextBox` control is created on the form, as shown in Figure 3-1. When you create `TextBox` controls, they are automatically given default names such as `textBox1`, `textBox2`, and so forth. As you learned in Chapter 2, you should always change a control's default name to something more meaningful.

When the user types into a `TextBox` control, the text is stored in the control's `Text` property. In code, if you want to retrieve the data that has been typed into a `TextBox`, you simply retrieve the contents of the control's `Text` property.



**Figure 3-1** A TextBox control

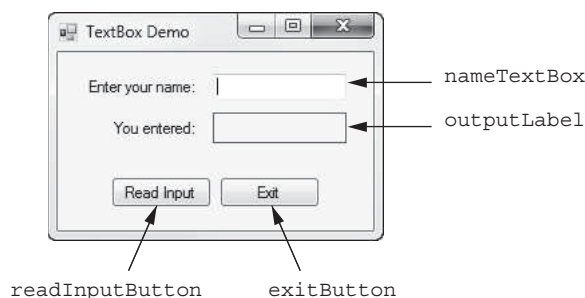
**NOTE:** When you retrieve the contents of the Text property, you *always* get a string. Any operation that can be performed on a string can be performed on a control's Text property.

Let's look at an example. Make sure you have downloaded the student sample programs from the book's companion Web site (at [www.pearsonhighered.com/gaddis](http://www.pearsonhighered.com/gaddis)). In the *Chap03* folder, you will find a project named *TextBox Demo*. Figure 3-2 shows the form, with most of the control names specified, and Figure 3-3 shows the form's code. (In Figure 3-3, to conserve space on the page, we have scrolled past the `using` directives that appear at the top of the code file.)

Notice in Figure 3-3 that the `readInputButton` control's Click event handler performs the following assignment statement:

```
outputLabel.Text = nameTextBox.Text;
```

This statement assigns the value of the `nameTextBox` control's Text property to the `outputLabel` control's Text property. In other words, it gets any text that has been entered by the user into the `nameTextBox` control and displays it in the `outputLabel` control. If you run the application, Figure 3-4 shows an example of how the form appears after you have entered *Kathryn Smith* and clicked the `readInputButton` control.

**Figure 3-2** The *TextBox Demo* application

## Clearing the Contents of a TextBox Control

You can clear the contents of a TextBox control in the same way that you clear the contents of a Label control: you assign an empty string ("") to the control's Text property. For example, the following statement clears the contents of the `nameTextBox` control:

```
nameTextBox.Text = "";
```

**Figure 3-3** The form's code (excluding the `using` directives)

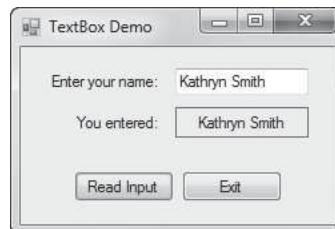
```

Form1.cs
namespace TextBox_Demo
{
    public partial class Form1 : Form
    {
        public Form1()
        {
            InitializeComponent();
        }

        private void readInputButton_Click(object sender, EventArgs e)
        {
            // Assign the name entered by the user to the
            // outputLabel control's Text property.
            outputLabel.Text = nameTextBox.Text;
        }

        private void exitButton_Click(object sender, EventArgs e)
        {
            // Close the form.
            this.Close();
        }
    }
}

```

**Figure 3-4** The user's name displayed in the label

When this statement executes, the `nameTextBox` control will appear empty on the application's form.

### Checkpoint

- 3.1 What control can be used to gather text input from the user?
- 3.2 In code, how do you retrieve data that has been typed into a `TextBox` control?
- 3.3 What type of data does a control's `Text` property always contain?
- 3.4 How do you clear the contents of a `TextBox` control?

## 3.2 A First Look at Variables

**CONCEPT:** A variable is a storage location in memory that is represented by a name.

Most programs store data in the computer's memory and perform operations on that data. For example, consider the typical online shopping experience: you browse a Web

site and add the items that you want to purchase to the shopping cart. As you add items to the shopping cart, data about those items is stored in memory. Then, when you click the *checkout* button, a program running on the Web site's computer calculates the cost of all the items you have in your shopping cart, applicable sales taxes, shipping costs, and the total of all these charges. When the program performs these calculations, it stores the results in the computer's memory.

Programs use variables to store data in memory. A **variable** is a storage location in memory that is represented by a name. For example, a program that manages a company's customer mailing list might use a variable named `lastName` to hold a customer's last name, a variable named `firstName` to hold the customer's first name, a variable named `address` to hold the customer's mailing address, and so on.

In C#, you must declare a variable in a program before you can use it to store data. You do this with a **variable declaration**, which specifies two things about the variable:

1. The variable's data type, which is the type of data the variable will hold
2. The variable's name

A variable declaration statement is written in this general format:

```
DataType VariableName;
```

Let's take a closer look at each of these.

## Data Type

A variable's **data type** indicates the type of data that the variable will hold. Before you declare a variable, you need to think about the type of value that will be stored in the variable. For example, will the variable hold a string or a number? If it will hold a number, what kind of number will it be, an integer or a real number? When you have determined the kind of data that the variable will hold, you select one of the data types that C# provides for a variable.

The C# language provides many data types for storing fundamental types of data, such as strings, integers, and real numbers. These data types are known as **primitive data types**. We will look at several of them in this chapter.

## Variable Name

A **variable name** identifies a variable in the program code. When naming a variable, you should always choose a meaningful name that indicates what the variable is used for. For example, a variable that holds the temperature might be named `temperature`, and a variable that holds a car's speed might be named `speed`. You may be tempted to give variables short, nondescript names such as `x` or `b2`, but names such as these give no clue as to the purpose of the variable.

In addition, there are some specific rules that you must follow when naming a variable. The same rules for identifiers that apply to control names also apply to variable names. We discussed these rules in Chapter 2, but we review them now:

- The first character must be one of the letters *a* through *z* or *A* through *Z* or an underscore character (`_`).
- After the first character, you may use the letters *a* through *z* or *A* through *Z*, the digits 0 through 9, or underscores.
- The name cannot contain spaces.

When naming variables, we use the same camelCase naming convention that we introduced in Chapter 2 for control names. For example, if we are declaring a variable to hold

an employee's gross pay, we might name it `grossPay`. Or, if we are declaring a variable to a customer number, we might name it `customerNumber`.

## string Variables

The first primitive data type we consider is the `string` data type. A variable of the `string` data type can hold any string of characters, such as a person's name, address, password, and so on. Here is an example of a statement that declares a `string` variable named `productDescription`:

```
string productDescription;
```

After the variable has been declared, you can use the assignment operator (`=`) to store a value in the variable. Here is an example:

```
productDescription = "Italian Espresso Machine";
```

When this statement executes, the string literal `"Italian Espresso Machine"` is assigned to the `productDescription` variable. When writing an assignment statement, remember that the assignment operator assigns the value that appears on its right side to the variable that appears on its left side.

Once you have assigned a value to a variable, you can use the variable in other operations. For example, assume `productLabel` is the name of a `Label` control. The following statement assigns the `productDescription` string to the `productLabel` control's `Text` property:

```
productLabel.Text = productDescription;
```

After this statement executes, the string that is stored in the `productDescription` variable is displayed in the `productLabel` control. The following statement shows another example:

```
MessageBox.Show(productDescription);
```

When this statement executes, the string that is stored in the `productDescription` variable is displayed in a message box.

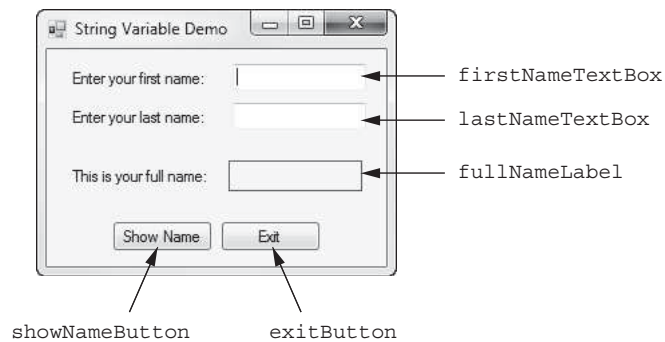
## String Concatenation

A common operation that is performed on strings is **concatenation**, or appending one string to the end of another string. In C# you use the `+` operator to concatenate strings. The `+` operator produces a string that is the combination of the two strings used as its operands. The following code shows an example:

```
string message;  
message = "Hello " + "world";  
MessageBox.Show(message);
```

The first statement declares a `string` variable named `message`. The second statement combines the strings `"Hello "` and `"world"` to produce the string `"Hello world"`. The string `"Hello world"` is then assigned to the `message` variable. The third statement displays the contents of the `message` variable in a message box. When the message box is displayed, it shows the string *Hello world*.

Let's look at an application that further demonstrates string concatenation. In the *Chap03* folder of this book's student sample programs (available for download at [www.pearsonhighered.com/gaddis](http://www.pearsonhighered.com/gaddis)), you will find a project named *String Variable Demo*. Figure 3-5 shows the form, with most of the control names specified, and Figure 3-6 shows the form's code. (In Figure 3-6, to conserve space on the page, we have scrolled past the using directives that appear at the top of the code file.)

Figure 3-5 The *String Variable Demo* applicationFigure 3-6 The form's code (excluding the `using` directives)

```

Form1.cs
String_Variable_Demo.Form1 Form1()

namespace String_Variable_Demo
{
    public partial class Form1 : Form
    {
        public Form1()
        {
            InitializeComponent();
        }

        private void showNameButton_Click(object sender, EventArgs e)
        {
            // Declare a string variable to hold the full name.
            ① → string fullName;

            // Combine the names, with a space between them. Assign the
            // result to the fullName variable.
            ② → fullName = firstNameTextBox.Text + " " + lastNameTextBox.Text;

            // Display the fullName variable in the fullNameLabel control.
            ③ → fullNameLabel.Text = fullName;
        }

        private void exitButton_Click(object sender, EventArgs e)
        {
            // Close the form.
            this.Close();
        }
    }
}

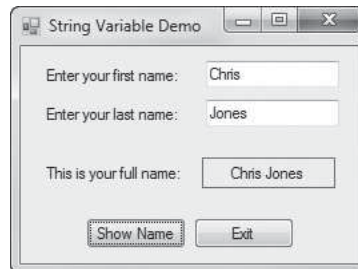
```

In Figure 3-6, three statements in the `showNameButton_Click` event handler are pointed out:

- ① This statement is a variable declaration. It declares a `string` variable named `fullName`.
- ② This statement assigns the result of a string concatenation to the `fullName` variable. The string that is assigned to the variable begins with the value of the `firstNameTextBox` control's `Text` property, followed by a space (" "), followed by the value of the `lastNameTextBox` control's `Text` property. For example, if the user has entered *Joe* into the `firstNameTextBox` control and *Smith* into the `lastNameTextBox` control, this statement will assign the string "Joe Smith" to the `fullName` variable.
- ③ This statement assigns the `fullName` variable to the `fullNameLabel` control's `Text` property. As a result, the string that is stored in the `fullName` variable is displayed in the `fullNameLabel` control.

If you run the application, Figure 3-7 shows an example of how the form appears after you have entered *Chris* for the first name and *Jones* for the last name and clicked the `showNameButton` control.

**Figure 3-7** The user's full name displayed in the label



## Declaring Variables before Using Them

The purpose of a variable declaration statement is to tell the compiler that you plan to use a variable of a specified name to store a particular type of data in the program. A variable declaration statement causes the variable to be created in memory. For this reason, a variable's declaration statement must appear *before* any other statements in the method that use the variable. This makes perfect sense because you cannot store a value in a variable if the variable has not been created in memory.

## Local Variables

Notice that the `fullName` variable in Figure 3-6 is declared inside the event handler method. Variables that are declared inside a method are known as local variables. A **local variable** belongs to the method in which it is declared, and only statements inside that method can access the variable. (The term *local* is meant to indicate that the variable can be used only locally, within the method in which it is declared.)

An error will occur if a statement in one method tries to access a local variable that belongs to another method. For example, let's go over the sample code shown in Figure 3-8:

- ① This statement declares a `string` variable named `myName`. The variable is declared inside the `firstButton_Click` event handler, so it is local to that method.
- ② This statement, which is also in the `firstButton_Click` event handler, assigns the `nameTextBox` control's `Text` property to the `myName` variable.

**Figure 3-8** One method trying to access a variable that is local to another method

```

private void firstButton_Click(object sender, EventArgs e)
{
    // Declare a string variable.
    ① → string myName;

    // Assign the nameTextBox control's Text property
    // to the myName variable.
    ② → myName = nameTextBox.Text;
}

private void secondButton_Click(object sender, EventArgs e)
{
    // Assign the myName variable to the outputLabel
    // control's Text property.
    ③ → outputLabel.Text = myName; ← ERROR!
}

```

- ③ This statement, which is in the `secondButton_Click` event handler, *attempts* to assign the `myName` variable to the `outputLabel` control's `Text` property. This statement will not work, however, because the `myName` variable is local to the `firstButton_Click` event handler, and statements in the `secondButton_Click` event handler cannot access it.

## Scope of a Variable

Programmers use the term **scope** to describe the part of a program in which a variable may be accessed. A variable is visible only to statements inside the variable's scope.

A local variable's scope begins at the variable's declaration and ends at the end of the method in which the variable is declared. As you saw in the previous example, a local variable cannot be accessed by statements that are outside the method. In addition, a local variable cannot be accessed by code that is inside the method but before the variable's declaration.

## Lifetime of a Variable

A variable's **lifetime** is the time period during which the variable exists in memory while the program is executing. A local variable is created in memory when the method in which it is declared starts executing. When the method ends, all the method's local variables are destroyed. So, a local variable's lifetime is the time during which the method in which it is declared is executing.

## Duplicate Variable Names

You cannot declare two variables with the same name in the same scope. For example, if you declare a variable named `productDescription` in an event handler, you cannot declare another variable with that name in the same event handler. You can, however, have variables of the same name declared in different methods.

## Assignment Compatibility

You can assign a value to a variable only if the value is compatible with the variable's data type. Only strings are compatible with the `string` data type, so all the assignments in the following code sample work:

```

1 // Declare and initialize a string variable.
2 string productDescription = "Chocolate Truffle";
3
4 // Declare another string variable.
5 string myFavoriteProduct;
6
7 // Assign a value to a string variable.
8 myFavoriteProduct = productDescription;
9
10 // Assign a value from a TextBox to a string variable.
11 productDescription = userInputTextBox.Text;
```

The following comments explain these lines of code:

- In line 2 we initialize a `string` variable with a string literal. This works because string literals are assignment compatible with `string` variables.
- In line 8 we assign a `string` variable to another `string` variable. This works for the obvious reason that `string` variables are compatible with other `string` variables.

- Assume that the application has a `TextBox` control named `userInputTextBox`. In line 11 we assign the value of the `TextBox` control's `Text` property to a `string` variable. This works because the value in a control's `Text` property is always a `string`.

The following code will not work, however, because it attempts to assign a nonstring value to a `string` variable:

```
1 // Declare a string variable.
2 string employeeID;
3
4 // Assign a value to the variable. Will this work?
5 employeeID = 125; ← ERROR!
```

In line 5 we are attempting to assign the number 125 to a `string` variable. Numbers are not assignment compatible with `string` variables, so this statement will cause an error when the code is compiled.



**NOTE:** Although you cannot store the number 125 in a `string` variable, you can store the `string` literal "125" in a `string` variable.

## A Variable Holds One Value at a Time

Variables can hold different values while a program is running, but they can hold only one value at a time. When you assign a value to a variable, that value will remain in the variable until you assign a different value to the variable. For example, look at the following code sample:

```
1 // Declare a string variable.
2 string productDescription;
3
4 // Assign a value to the variable.
5 productDescription = "Large Medium-Roast Coffee";
6
7 // Display the variable's value.
8 MessageBox.Show(productDescription);
9
10 // Assign a different value to the variable.
11 productDescription = "Chocolate Truffle";
12
13 // Display the variable's value.
14 MessageBox.Show(productDescription);
```

The following comments explain what we did:

- Line 2 declares a `string` variable named `productDescription`.
- Line 5 assigns the `string` "Large Medium-Roast Coffee" to the `productDescription` variable.
- Line 8 displays the value of the `productDescription` variable in a message box. (The message box will display *Large Medium-Roast Coffee*.)
- Line 11 assigns a different value to the `productDescription` variable. After this statement executes, the `productDescription` variable will hold the `string` "Chocolate Truffle".
- Line 14 displays the value of the `productDescription` variable in a message box. (The message box will display *Chocolate Truffle*.)



This code sample illustrates two important characteristics of variables:

- A variable holds only one value at a time.
- When you store a value in a variable, that value replaces the previous value that was in the variable.

Tutorial 3-1 gives you some practice using variables. You will create an application that uses `TextBox` controls to get input values, stores those values in variables, and uses the variables in operations.



VideoNote

**Tutorial 3-1:**  
The *Birth Date String*  
Application



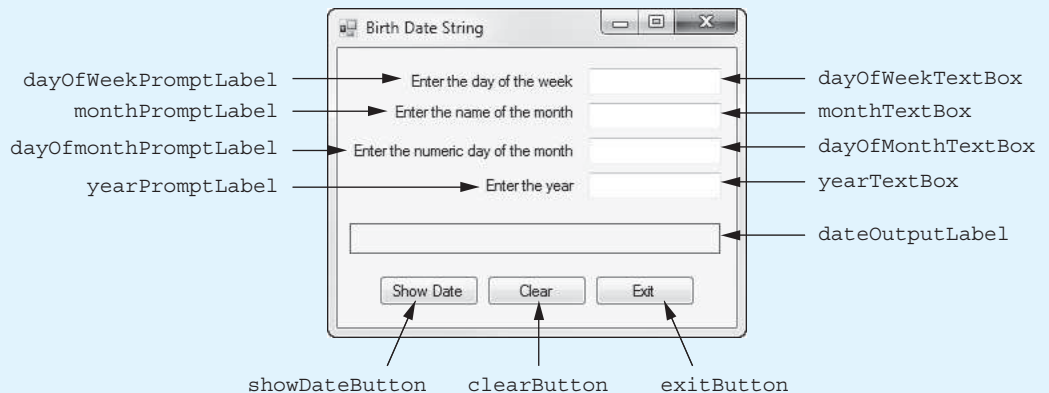
### Tutorial 3-1: The *Birth Date String* Application

In this tutorial you create an application that lets the user enter the following information about his or her birthdate:

- The day of the week (Monday, Tuesday, etc.)
- The name of the month (January, February, etc.)
- The numeric day of the month
- The year

Figure 3-9 shows the application's form, along with the names of all the controls. When the application runs, the user enters each piece of data into a separate `TextBox`. When the user clicks the *Show Date* button, the application concatenates the contents of the `TextBox`s into a string such as *Friday, June 1, 1990*. The string is displayed in the `dateOutputLabel` control. When the user clicks the *Clear* button, the contents of the `TextBox`s and the `dateOutputLabel` control are cleared. The *Exit* button closes the application's form.

**Figure 3-9** The *Birth Date String* form



**Step 1:** Start Visual Studio (or Visual Studio Express) and begin a new Windows Forms Application project named *Birth Date String*.

**Step 2:** Set up the application's form as shown in Figure 3-9. Notice that the form's `Text` property is set to *Birth Date String*. The names of the controls are shown in the figure. As you place each control on the form, refer to Table 3-1 for the relevant property settings.

**Step 3:** Once you have set up the form with its controls, you can create the `Click` event handlers for the `Button` controls. At the end of this tutorial, Program 3-1 shows the completed code for the form. You will be instructed to refer to Program 3-1

**Table 3-1** Control property settings

Control Name	Control Type	Property Settings
dayOfWeekPromptLabel	Label	<b>Text:</b> <i>Enter the day of the week</i>
monthPromptLabel	Label	<b>Text:</b> <i>Enter the name of the month</i>
dayOfMonthPromptLabel	Label	<b>Text:</b> <i>Enter the numeric day of the month</i>
yearPromptLabel	Label	<b>Text:</b> <i>Enter the year</i>
dayOfWeekTextBox	TextBox	No properties changed
monthTextBox	TextBox	No properties changed
dayOfMonthTextBox	TextBox	No properties changed
yearTextBox	TextBox	No properties changed
dateOutputLabel	Label	<b>AutoSize:</b> False <b>BorderStyle:</b> FixedSingle <b>Text:</b> (The contents of the Text property have been erased.) <b>TextAlign:</b> MiddleCenter
showDateButton	Button	<b>Text:</b> <i>Show Date</i>
clearButton	Button	<b>Text:</b> <i>Clear</i>
exitButton	Button	<b>Text:</b> <i>Exit</i>

as you write the event handlers. (Remember, the line numbers that are shown in Program 3-1 are not part of the program. They are shown for reference only.)

In the *Designer*, double-click the `showDateButton` control. This will open the code editor, and you will see an empty event handler named `showDateButton_Click`. Complete the `showDateButton_Click` event handler by typing the code shown in lines 22–32 in Program 3-1.

Let’s take a closer look at the code:

**Line 23:** This statement declares a `string` variable named `output`.

**Lines 26–29:** These lines are actually one long statement, broken up into multiple lines. The statement concatenates the `Text` properties of the `TextBox` controls, along with appropriately placed commas and spaces, to create the date string. The resulting string is assigned to the `output` variable.

For example, suppose the user has entered the following input:

- *Friday* in the `dayOfWeekTextBox` control.
- *June* in the `monthTextBox` control.
- *1* in the `dayOfMonthTextBox` control.
- *1990* in the `yearTextBox` control.

The concatenation in this statement produces the string “June 1, 1990”; it is assigned to the `output` variable.

**Line 32:** This statement assigns the `output` variable to the `dateOutputLabel` control’s `Text` property. When this statement executes, the contents of the `output` variable are displayed in the `dateOutputLabel` control.

**Step 4:** Switch your view back to the *Designer* and double-click the `clearButton` control. In the code editor, you will see an empty event handler named


`clearButton_Click`. Complete the `clearButton_Click` event handler by typing the code shown in lines 37–44 in Program 3-1.

Let's take a closer look at the code:

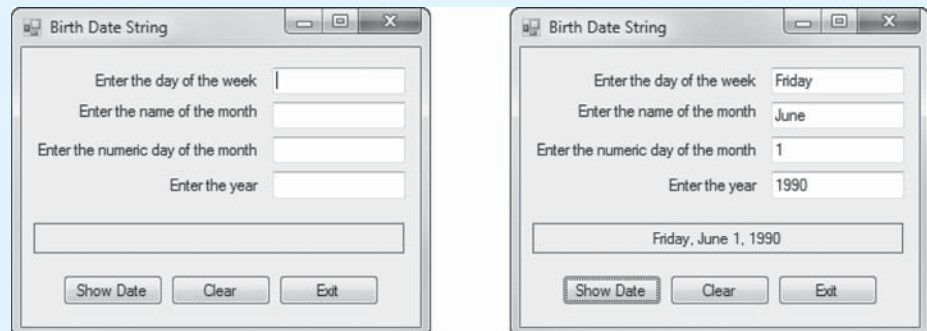
**Lines 38–41:** Each statement assigns an empty string ("") to the `Text` property of one of the `TextBox` controls. When these statements have finished executing, the `TextBox` controls will appear empty.

**Line 44:** This statement assigns an empty string ("") to the `dateOutputLabel` control's `Text` property. After the statement has executed, the label appears empty.

**Step 5:** Switch your view back to the *Designer* and double-click the `exitButton` control. In the code editor, you will see an empty event handler named `exitButton_Click`. Complete the `exitButton_Click` event handler by typing the code shown in lines 49–50 in Program 3-1.

**Step 6:** Save the project. Then, press the `(F5)` key on the keyboard, or click the *Start Debugging* button  on the toolbar to compile and run the application. The form will appear as shown in the image on the left in Figure 3-10. Test the application by entering values into the `TextBox`s and clicking the *Show Date* button. The date should be displayed, similar to the image shown on the right in the figure. Click the *Clear* button, and the contents of the `TextBox`s and the `Label` control should clear. Click the *Exit* button and the form should close.

**Figure 3-10** The *Birth Date String* application



**Program 3-1** Completed `Form1` code for the *Birth Date String* application

```

1 using System;
2 using System.Collections.Generic;
3 using System.ComponentModel;
4 using System.Data;
5 using System.Drawing;
6 using System.Linq;
7 using System.Text;
8 using System.Threading.Tasks;
9 using System.Windows.Forms;
10
11 namespace Birth_Date_String
12 {
13     public partial class Form1 : Form
14     {
15         public Form1()

```

```
16     {
17         InitializeComponent();
18     }
19
20     private void showDateButton_Click(object sender, EventArgs e)
21     {
22         // Declare a string variable.
23         string output;
24
25         // Concatenate the input and build the output string.
26         output = dayOfWeekTextBox.Text + ", " +
27                 monthTextBox.Text + " " +
28                 dayOfMonthTextBox.Text + ", " +
29                 yearTextBox.Text;
30
31         // Display the output string in the Label control.
32         dateOutputLabel.Text = output;
33     }
34
35     private void clearButton_Click(object sender, EventArgs e)
36     {
37         // Clear the TextBoxes.
38         dayOfWeekTextBox.Text = "";
39         monthTextBox.Text = "";
40         dayOfMonthTextBox.Text = "";
41         yearTextBox.Text = "";
42
43         // Clear the dateOutputLabel control.
44         dateOutputLabel.Text = "";
45     }
46
47     private void exitButton_Click(object sender, EventArgs e)
48     {
49         // Close the form.
50         this.Close();
51     }
52 }
53 }
```



**NOTE:** In Tutorial 3-1, the statement in lines 26–29 shows an example of how you can break up a statement into multiple lines. Quite often, you will find yourself writing statements that are too long to fit entirely inside the *Code* window. Your code will be hard to read if you have to horizontally scroll the *Code* window to view long statements. In addition, if you or your instructor chooses to print your code, the statements that are too long to fit on one line of the page will wrap around to the next line and make your code look unorganized. For these reasons, it is usually best to break a long statement into multiple lines.

When typing most statements, you can simply press the Enter key when you reach an appropriate point to continue the statement on the next line. Remember, however, that you cannot break up a keyword, a quoted string, or an identifier (such as a variable name or a control name).

## Initializing Variables

In C#, a variable must be assigned a value before it can be used. For example, look at this code:

```
string productDescription;
MessageBox.Show(productDescription);
```

This code declares a `string` variable named `productDescription` and then tries to display the variable's value in a message box. The only problem is that we have not assigned a value to the variable. When we compile the application containing this code, we will get an error message such as *Use of unassigned local variable 'productDescription'*. The C# compiler will not compile code that tries to use an unassigned variable.

One way to make sure that a variable has been assigned a value is to **initialize** the variable with a value when you declare it. For example, the following statement declares a `string` variable named `productDescription` and immediately assigns the string literal "Chocolate Truffle" to it:

```
string productDescription = "Chocolate Truffle";
```

We say that this statement *initializes* the `productDescription` variable with the string "Chocolate Truffle". Here is another example:

```
string lastName = lastNameTextBox.Text;
```

Assume that this statement belongs to an application that has a `TextBox` named `lastNameTextBox`. The statement declares a `string` variable named `lastName` and initializes it with the value of the `lastNameTextBox` control's `Text` property.

## Declaring Multiple Variables with One Statement

You can declare multiple variables of the same data type with one declaration statement. Here is an example:

```
string lastName, firstName, middleName;
```

This statement declares three `string` variables named `lastName`, `firstName`, and `middleName`. Notice that commas separate the variable names. Here is an example of how we can declare and initialize the variables with one statement:

```
string lastName = "Jones", firstName = "Jill", middleName = "Rebecca";
```

Remember, you can break up a long statement so it spreads across two or more lines. Sometimes you will see long variable declarations written across multiple lines, like this:

```
string lastName = "Jones",
    firstName = "Jill",
    middleName = "Rebecca";
```



### Checkpoint

- 3.5 What is the purpose of a variable?
- 3.6 Give an example of a variable declaration that will store the name of your favorite food.

- 3.7 For each of the following items, determine whether the data type should be an integer, string, or real number.
- pet name
  - sales tax
  - mailing address
  - video game score
- 3.8 Indicate whether each of the following is a legal variable name. If it is not, explain why.
- pay\_Rate
  - speed of sound
  - totalCost
  - 2ndPlaceName
- 3.9 What will be stored in the `message` variable after the following statement is executed?
- ```
string message = "He" + "ll" + "o!";
```
- 3.10 What is the lifetime of a variable that is declared inside of a Click event handler?
- 3.11 Assuming the variable `greeting` has not been assigned a value, what will be the result of the following statement?
- ```
MessageBox.Show(greeting);
```
- 3.12 Will the following statement cause an error? Why or why not?
- ```
string luckyNumber = 7;
```
- 3.13 Write a single declaration statement for the variables `name`, `city`, and `state`.

## 3.3 Numeric Data Types and Variables

**CONCEPT:** If you need to store a number in a variable and use that number in a mathematical operation, the variable must be of a numeric data type. You select a numeric data type that is appropriate for the type of number that you need to store.

In the previous section you read about `string` variables. Variables of the `string` data type can be used to store text, but they cannot store numeric data for the purpose of performing mathematical operations. If you need to store numbers and perform mathematical operations on them, you have to use a numeric data type.

The C# language provides several primitive data types. You can read about all the C# primitive data types in Appendix A. Many of the data types provided by C# are for specialized purposes beyond the scope of this book. When it comes to numeric data, most of the time you will use the three numeric primitive data types described in Table 3-2.

Here are examples of declaring variables of each data type:

```
int speed;  
double distance;  
decimal grossPay;
```

The first statement declares an `int` variable named `speed`. The second example declares a `double` variable named `distance`. The third statement declares a `decimal` variable named `grossPay`.

**Table 3-2** The primitive numeric data types that you will use most often

| Data Type            | Description                                                                                                                                                                                                                                                                                                                                                                                                                                                                                                                                                                                                                                                                                                                                                                                                           |
|----------------------|-----------------------------------------------------------------------------------------------------------------------------------------------------------------------------------------------------------------------------------------------------------------------------------------------------------------------------------------------------------------------------------------------------------------------------------------------------------------------------------------------------------------------------------------------------------------------------------------------------------------------------------------------------------------------------------------------------------------------------------------------------------------------------------------------------------------------|
| <code>int</code>     | <p>A variable of the <code>int</code> data type can hold whole numbers only. For example, an <code>int</code> variable can hold values such as 42, 0, and <math>-99</math>. An <code>int</code> variable cannot hold numbers with a fractional part, such as 22.1 or <math>-4.9</math>.</p> <p>The <code>int</code> data type is the primary data type for storing integers. We use it in this book any time we need to store and work with integers. An <code>int</code> variable uses 32 bits of memory and can hold an integer number in the range of <math>-2,147,483,648</math> through <math>2,147,483,647</math>.</p>                                                                                                                                                                                          |
| <code>double</code>  | <p>A variable of the <code>double</code> data type can hold real numbers, such as 3.5, <math>-87.95</math>, or 3.0. A number that is stored in a <code>double</code> variable is rounded to 15 digits of precision.</p> <p>We use variables of the <code>double</code> data type to store any number that might have a fractional part. The <code>double</code> data type is especially useful for storing extremely great or extremely small numbers.</p> <p>In memory a <code>double</code> variable uses 64 bits of memory. It is stored in a format that programmers call <i>double precision floating-point notation</i>. Variables of the <code>double</code> data type can hold numbers in the range of <math>\pm 5.0 \times 10^{2324}</math> to <math>\pm 1.7 \times 10^{308}</math>.</p>                     |
| <code>decimal</code> | <p>A variable of the <code>decimal</code> data type can hold real numbers with greater precision than the <code>double</code> data type. A number that is stored in a <code>decimal</code> variable is rounded to 28 digits of precision.</p> <p>Because <code>decimal</code> variables store real numbers with a great deal of precision, they are most commonly used in financial applications. In this book we typically use the <code>decimal</code> data type when storing amounts of money.</p> <p>In memory a <code>decimal</code> variable uses 128 bits of memory. It is stored in a format that programmers call <i>decimal notation</i>. Variables of the <code>decimal</code> data type can hold numbers in the range of <math>\pm 1.0 \times 10^{228}</math> to <math>\pm 7.9 \times 10^{28}</math>.</p> |

## Numeric Literals

You learned in Chapter 2 that a literal is a piece of data written into a program's code. When you know, at the time that you are writing a program's code, that you want to store a specific value in a variable, you can assign that value as a literal to the variable.

A **numeric literal** is a number that is written into a program's code. For example, the following statement declares an `int` variable named `hoursWorked` and initializes it with the value 40:

```
int hoursWorked = 40;
```

In this statement, the number 40 is a numeric literal. The following shows another example:

```
double temperature = 87.6;
```

This statement declares a `double` variable named `temperature` and initializes it with the value 87.6. The number 87.6 is a numeric literal.

When you write a numeric literal in a program's code, the numeric literal is assigned a data type. In C#, if a numeric literal is an integer (not written with a decimal point) and it fits within the range of an `int` (see Table 3-2 for the minimum and maximum values), then the numeric literal is treated as an `int`. A numeric literal that is treated as an `int` is called an **integer literal**. For example, each of the following statements initializes a variable with an integer literal:

```
int hoursWorked = 40;
int unitsSold = 650;
int score = -23;
```

If a numeric literal is written with a decimal point and it fits within the range of a `double` (see Table 3-2 for the minimum and maximum values), then the numeric literal is treated as a `double`. A numeric literal that is treated as a `double` is called a **double literal**. For example, each of the following statements initializes a variable with a double literal:

```
double distance = 28.75;
double speed = 87.3;
double temperature = -10.0;
```

When you append the letter `M` or `m` to a numeric literal, it is treated as a `decimal` and is referred to as a **decimal literal**. Here are some examples:

```
decimal payRate = 28.75m;
decimal price = 8.95M;
decimal profit = -50m;
```



**TIP:** Because `decimal` is the preferred data type for storing monetary amounts, remembering that “m” stands for “money” might help you to remember that `decimal` literals must end with the letter `M` or `m`.

## Assignment Compatibility for `int` Variables

You can assign `int` values to `int` variables, but you cannot assign `double` or `decimal` values to `int` variables. For example, look at the following declarations.

```
int hoursWorked = 40; ← This works
int unitsSold = 650m; ← ERROR!
int score = -25.5; ← ERROR!
```

The first declaration works because we are initializing an `int` variable with an `int` value. The second declaration causes an error, however, because you cannot assign a `decimal` value to an `int` variable. The third declaration also causes an error because you cannot assign a `double` value to an `int` variable.

You cannot assign a `double` or a `decimal` value to an `int` variable because such an assignment could result in a loss of data. Here are the reasons:

- The `double` and `decimal` values may be fractional, but `int` variables can hold only integers. If you were allowed to store a fractional value in an `int` variable, the fractional part of the value would have to be discarded.



- The `double` and `decimal` values may be much larger or much smaller than allowed by the range of an `int` variable. A `double` or a `decimal` number can potentially be so large or so small that it will not fit in an `int` variable.

## Assignment Compatibility for `double` Variables

You can assign either `double` or `int` values to `double` variables, but you cannot assign `decimal` values to `double` variables. For example, look at the following declarations.

```
double distance = 28.75; ← This works
double speed = 75;      ← This works
double sales = 6500.0m; ← ERROR!
```

The first declaration works because we are initializing a `double` variable with a `double` value. The second declaration works because we are initializing a `double` variable with an `int` value. The third declaration causes an error, however, because you cannot assign a `decimal` value to a `double` variable.

It makes sense that you are allowed to assign an `int` value to a `double` variable because any number that can be stored as an `int` can be converted to a `double` with no loss of data. When you assign an `int` value to a `double` variable, the `int` value is implicitly converted to a `double`.

You cannot assign a `decimal` value to a `double` variable because the `decimal` data type allows for much greater precision than the `double` data type. A `decimal` value can have up to 28 digits of precision, whereas a `double` can provide only 15 digits of precision. Storing a `decimal` value in a `double` variable could potentially result in a loss of data.

## Assignment Compatibility for `decimal` Variables

You can assign either `decimal` or `int` values to `decimal` variables, but you cannot assign `double` values to `decimal` variables. For example, look at the following declarations.

```
decimal balance = 9280.73m; ← This works
decimal price = 50;         ← This works
decimal sales = 6500.0;     ← ERROR!
```

The first declaration works because we are initializing a `decimal` variable with a `decimal` value. The second declaration works because we are initializing a `decimal` variable with an `int` value. When you assign an `int` value to a `decimal` variable, the `int` value is implicitly converted to a `decimal` with no loss of data. The third declaration causes an error, however, because you cannot assign a `double` value to a `decimal` variable. A `double` value can potentially be much larger or much smaller than allowed by the range of a `decimal`.

## Explicitly Converting Values with Cast Operators

Let's consider a hypothetical situation. Suppose you've written an application that uses a `double` variable, and for some reason, you need to assign the contents of the `double` variable to an `int` variable. In this particular situation, you know that the `double` variable's value is something that can be safely converted to an `int` without any loss of data (such as 3.0, or 98.0). However, the C# compiler will not allow you to make the assignment because `double` values are not assignment compatible with `int` variables. Isn't there a way to override the C# rules in this particular situation and make the assignment anyway?

The answer is yes, there is a way. You can use a **cast operator** to explicitly convert a value from one numeric data type to another, even if the conversion might result in a loss of data. A cast operator is the name of the desired data type, written inside parentheses and placed to the left of the value that you want to convert. The following code sample demonstrates:

```

1 // Declare an int variable.
2 int wholeNumber;
3
4 // Declare a double variable.
5 double realNumber = 3.0;
6
7 // Assign the double to the int.
8 wholeNumber = (int)realNumber;

```

The following points describe the code:

- Line 2 declares an `int` variable named `wholeNumber`.
- Line 5 declares a `double` variable named `realNumber`, initialized with the value 3.0.
- Line 8 uses a cast operator to convert the value of `realNumber` to an `int` and assigns the converted value to `wholeNumber`. After this statement executes, the `wholeNumber` variable is assigned the value 3.

Table 3-3 shows other code examples involving different types of cast operators.

**Table 3-3** Examples of uses of cast operators

| Code Example                                                                                   | Description                                                                                                                                                                                               |
|------------------------------------------------------------------------------------------------|-----------------------------------------------------------------------------------------------------------------------------------------------------------------------------------------------------------|
| <pre>int wholeNumber; decimal moneyNumber = 4500m; wholeNumber = (int)moneyNumber;</pre>       | The <code>(int)</code> cast operator converts the value of the <code>moneyNumber</code> variable to an <code>int</code> . The converted value is assigned to the <code>wholeNumber</code> variable.       |
| <pre>double realNumber; decimal moneyNumber = 625.70m; realNumber = (double)moneyNumber;</pre> | The <code>(double)</code> cast operator converts the value of the <code>moneyNumber</code> variable to a <code>double</code> . The converted value is assigned to the <code>realNumber</code> variable.   |
| <pre>decimal moneyNumber; double realNumber = 98.9; moneyNumber = (decimal)realNumber;</pre>   | The <code>(decimal)</code> cast operator converts the value of the <code>realNumber</code> variable to a <code>decimal</code> . The converted value is assigned to the <code>moneyNumber</code> variable. |

When you use a cast operator, you are essentially telling the compiler that you know what you are doing and you are willing to accept the consequences of the conversion. It is still possible that a loss of data can occur. For example, look at the following code sample:

```

int wholeNumber;
double realNumber = 8.9;
wholeNumber = (int)realNumber;

```

In this example, the `double` variable contains a fractional number. When the cast operator converts the fractional number to an `int`, the part of the number that appears after the decimal point is dropped. The process of dropping a number's fractional part is called **truncation**. After this code executes, the `wholeNumber` variable contains the value 8.

It's important to realize that when a cast operator is applied to a variable, it does not change the contents of the variable. The cast operator merely returns the value that is stored in the variable, converted to the specified data type. In the previous code sample, when the `(int)` cast operator is applied to the `realNumber` variable, the cast operator returns the value 8. The `realNumber` variable remains unchanged, however, still containing the value 8.9.


**Checkpoint**

- 3.14 Specify the appropriate primitive numeric data type to use for each of the following values.
- 24 dollars
  - 12 bananas
  - 14.5 inches
  - 83 cents
  - 2 concert tickets
- 3.15 Which of the following variable declarations will cause an error? Why?
- `decimal payRate = 24m;`
  - `int playerScore = 1340.5;`
  - `double boxWidth = 205.25;`
  - `string lastName = "Holm";`
- 3.16 Write a programming statement that will convert the following `decimal` variable to an `int` and store the result in an `int` variable named `dollars`:
- ```
decimal deposit = 976.54m;
```
- 3.17 What value will the `wholePieces` variable contain after the following code executes?
- ```
double totalPieces = 6.5;
int wholePieces = (int)totalPieces;
```

## 3.4 Performing Calculations

**CONCEPT:** You can use math operators to perform simple calculations. Math expressions can be written using the math operators and parentheses as grouping symbols. The result of a math expression can be assigned to a variable.

Most programs require calculations of some sort to be performed. A programmer's tools for performing calculations are **math operators**. C# provides the math operators shown in Table 3-4.

**Table 3-4** Math operators

| Operator | Name of the Operator | Description                                            |
|----------|----------------------|--------------------------------------------------------|
| +        | Addition             | Adds two numbers                                       |
| -        | Subtraction          | Subtracts one number from another                      |
| *        | Multiplication       | Multiplies one number by another                       |
| /        | Division             | Divides one number by another and gives the quotient   |
| %        | Modulus              | Divides one integer by another and gives the remainder |

Programmers use the operators shown in Table 3-4 to create math expressions. A **math expression** performs a calculation and gives a value. The following is an example of a simple math expression:

```
12 * 2
```

The values on the right and left of the `*` operator are called **operands**. These are values that the `*` operator multiplies together. The value that is given by this expression is 24.

Variables may also be used in a math expression. For example, suppose we have two variables named `hoursWorked` and `payRate`. The following math expression uses the `*` operator to multiply the value in the `hoursWorked` variable by the value in the `payRate` variable:

```
hoursWorked * payRate
```

When we use a math expression to calculate a value, we have to do something with the value. Normally we want to save the value in memory so we can use it again in the program. We do this with an assignment statement. For example, suppose we have another variable named `grossPay`. The following statement assigns the value `hoursWorked` times `payRate` to the `grossPay` variable:

```
grossPay = hoursWorked * payRate;
```

Here are some other examples of statements that assign the result of a math expression to a variable:

```
total = price + tax;
sale = price - discount;
commission = sales * percent;
half = number / 2;
```

The modulus operator (`%`) performs division between two integers, but instead of returning the quotient, it returns the remainder. The following statement assigns 2 to `leftOver`:

```
leftOver = 17 % 3;
```

This statement assigns 2 to `leftover` because 17 divided by 3 is 5 with a remainder of 2. You will not use the modulus operator frequently, but it is useful in some situations. It is commonly used in calculations that detect odd or even numbers, determine the day of the week, or measure the passage of time and in other specialized operations.

## The Order of Operations

You can write mathematical expressions with several operators. The following statement assigns the sum of 17, the variable `x`, 21, and the variable `y` to the variable `answer`.

```
answer = 17 + x + 21 + y;
```

Some expressions are not that straightforward, however. Consider the following statement:

```
outcome = 12 + 6 / 3;
```

What value will be stored in `outcome`? The number 6 is used as an operand for both the addition and division operators. The `outcome` variable could be assigned either 6 or 14, depending on when the division takes place. The answer is 14 because the **order of operations** dictates that the division operator works before the addition operator does.

The order of operations can be summarized as follows:

1. Perform any operations that are enclosed in parentheses.
2. Perform any multiplications, divisions, or modulus operations as they appear from left to right.
3. Perform any additions or subtractions as they appear from left to right.

Mathematical expressions are evaluated from left to right. Multiplication and division are always performed before addition and subtraction, so the statement

```
outcome = 12 + 6 / 3;
```

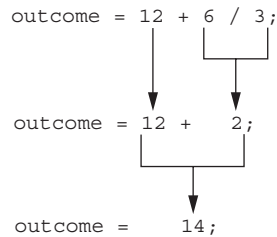
works like this:

1. 6 is divided by 3, yielding a result of 2.
2. 12 is added to 2, yielding a result of 14.

It could be diagrammed as shown in Figure 3-11.

Table 3-5 shows some other sample expressions with their values.

**Figure 3-11** The order of operations at work



**Table 3-5** Some math expressions and their values

| Expression          | Value |
|---------------------|-------|
| $5 + 2 * 4$         | 13    |
| $10 / 2 - 3$        | 2     |
| $8 + 12 * 2 - 4$    | 28    |
| $6 - 3 * 2 + 7 - 1$ | 6     |

### Grouping with Parentheses

Parts of a mathematical expression may be grouped with parentheses to force some operations to be performed before others. In the following statement, the variables a and b are added together, and their sum is divided by 4:

```
result = (a + b) / 4;
```

But what if we left the parentheses out, as shown here?

```
result = a + b / 4;
```

We would get a different result. Without the parentheses, b would be divided by 4 and the result added to a. Table 3-6 shows some math expressions that use parentheses and their values.

**Table 3-6** More expressions and their values

| Expression              | Value |
|-------------------------|-------|
| $(5 + 2) * 4$           | 28    |
| $10 / (5 - 3)$          | 5     |
| $8 + 12 * (6 - 2)$      | 56    |
| $(6 - 3) * (2 + 7) / 3$ | 9     |

## Mixing Data Types in a Math Expression

When you perform a math operation on two operands, the data type of the result will depend on the data type of the operands. If the operands are of the same data type, the result will also be of that data type. For example:

- When an operation is performed on two `int` values, the result will be an `int`.
- When an operation is performed on two `double` values, the result will be a `double`.
- When an operation is performed on two `decimal` values, the result will be a `decimal`.

It's not uncommon, however, for a math expression to have operands of different data types. C# handles operations involving `int`, `double`, and `decimal` operands in the following ways:

- When a math expression involves an `int` and a `double`, the `int` is temporarily converted to a `double`, and the result is a `double`.
- When a math expression involves an `int` and a `decimal`, the `int` is temporarily converted to a `decimal`, and the result is a `decimal`.
- Math expressions involving a `double` and a `decimal` are not allowed unless a cast operator is used to convert one of the operands.

For example, suppose a pay-calculating program has the following variable declarations:

```
int hoursWorked; // To hold the number of hours worked
decimal payRate; // To hold the hourly pay rate
decimal grossPay; // To hold the gross pay
```

Then, later in the program this statement appears:

```
grossPay = hoursWorked * payRate;
```

The math expression on the right side of the `=` operator multiplies an `int` by a `decimal`. When the statement executes, the value of the `hoursWorked` variable is temporarily converted to a `decimal` and then multiplied by the `payRate` variable. The result is a `decimal` and is assigned to the `grossPay` variable.

When possible, you should avoid math operations that use a mixture of `double` and `decimal` operands. C# does not allow operations involving these two types unless you use a cast operator to explicitly convert one of the operands. For example, suppose a program that calculates the cost of a product has the following variable declarations:

```
double weight; // The product weight
decimal pricePerPound; // The price per pound
decimal total; // The total cost
```

Later in the program you need to calculate the total cost, like this:

```
total = weight * pricePerPound; ← ERROR!
```

The compiler will not allow this statement because `weight` is a `double` and `pricePerPound` is a `decimal`. To fix the statement, you can insert a cast operator, as shown here:

```
total = (decimal)weight * pricePerPound;
```

The cast operator converts the value of the `weight` variable to a `decimal`, and the converted value is multiplied by `pricePerPound`. The result of the expression is a `decimal` and is assigned to `total`.

## Integer Division

When you divide an integer by an integer in C#, the result is always given as an integer. If the result has a fractional part, it is truncated. For example, look at the following code:

```
int length;           // Declare length as an int
double half;         // Declare half as a double
length = 75;         // Assign 75 to length
half = length / 2;   // Calculate half the length
```

The last statement divides the value of `length` by 2 and assigns the result to `half`. Mathematically, the result of 75 divided by 2 is 37.5. However, that is not the result that we get from the math expression. The `length` variable is an `int`, and it is being divided by the numeric literal 2, which is also treated as an `int`. The result of the division is truncated, giving the value 37. This is the value that is assigned to the `half` variable. It does not matter that the `half` variable is declared as a `double`. The fractional part of the result is truncated before the assignment takes place.

## Combined Assignment Operators

Sometimes you want to increase a variable's value by a certain amount. For example, suppose you have a variable named `number` and you want to increase its value by 1. You can accomplish that with the following statement:

```
number = number + 1;
```

The expression on the right side of the assignment operator calculates the value of `number` plus 1. The result is then assigned to `number`, replacing the value that was previously stored there. This statement effectively adds 1 to `number`. For example, if `number` is equal to 6 before this statement executes, it is equal to 7 after the statement executes.

Similarly, the following statement subtracts 5 from `number`:

```
number = number - 5;
```

If `number` is equal to 15 before this statement executes, it is equal to 10 after the statement executes. Here's another example. The following statement doubles the value of the `number` variable:

```
number = number * 2;
```

If `number` is equal to 4 before this statement executes, it is equal to 8 after the statement executes.

These types of operations are very common in programming. For convenience, C# offers a special set of operators known as **combined assignment operators** that are designed specifically for these jobs. Table 3-7 shows the combined assignment operators.

**Table 3-7** Combined assignment operators

| Operator        | Example Usage         | Equivalence              |
|-----------------|-----------------------|--------------------------|
| <code>+=</code> | <code>x += 5;</code>  | <code>x = x + 5;</code>  |
| <code>-=</code> | <code>y -= 2;</code>  | <code>y = y - 2;</code>  |
| <code>*=</code> | <code>z *= 10;</code> | <code>z = z * 10;</code> |
| <code>/=</code> | <code>a /= b;</code>  | <code>a = a / b;</code>  |
| <code>%=</code> | <code>c %= 3;</code>  | <code>c = c % 3;</code>  |

As you can see, the combined assignment operators do not require the programmer to type the variable name twice. Also, they give a clear indication of what is happening in the statement.

## Checkpoint

3.18 List the operands for the following math expression.

```
length * width
```

3.19 Summarize the mathematical order of operations.

3.20 Rewrite the following code segment so that it does not cause an error.

```
decimal pricePerFoot = 2.99m;  
double boardLength = 10.5;  
decimal totalCost = boardLength * pricePerFoot;
```

3.21 Assume `result` is a `double` variable. When the following statement executes, what value will be stored in `result`?

```
result = 4 + 10 / 2;
```

3.22 Assume `result` is an `int` variable. When the following statement executes, what value will be stored in `result`?

```
result = (2 + 5) * 10;
```

3.23 Assume `result` is a `double` variable. When the following statement executes, what value will be stored in `result`?

```
result = 5 / 2;
```

3.24 Rewrite the following statements using combined assignment operators:

```
a. count = count + 1;  
b. amount = amount - 5;  
c. radius = radius * 10;  
d. length = length / 2;
```

## 3.5 Inputting and Outputting Numeric Values

**CONCEPT:** If the user has entered a number into a `TextBox`, the number will be stored as a string in the `TextBox`'s `Text` property. If you want to store that number in a numeric variable, you have to convert it to the appropriate numeric data type. When you want to display the value of a numeric variable in a `Label` control or a message box, you have to convert it to a string.

### Getting a Number from a TextBox

GUI applications typically use `TextBox` controls to read keyboard input. Any data that the user enters into a `TextBox` control is stored in the control's `Text` property as a string, even if it is a number. For example, if the user enters the number 72 into a `TextBox` control, the input is stored as the string "72" in the control's `Text` property.

If the user has entered a numeric value into a `TextBox` control and you want to assign that value to a numeric variable, you have to convert the control's `Text` property to the desired numeric data type. Unfortunately, you cannot use a cast operator to convert a string to a numeric type.



To convert a string to any of the numeric data types, we use a family of methods in the .NET Framework known as the **Parse methods**. In computer science, the term **parse** typically means to analyze a string of characters for some purpose. The **Parse** methods are used to convert a string to a specific data type. There are several **Parse** methods in the .NET Framework, but because we are primarily using the `int`, `double`, and `decimal` numeric data types, we need only three of them:

- We use the **`int.Parse` method** to convert a string to an `int`.
- We use the **`double.Parse` method** to convert a string to a `double`.
- We use the **`decimal.Parse` method** to convert a string to a `decimal`.

When you call one of the **Parse** methods, you pass a piece of data known as an **argument** into the method, and the method returns a piece of data back to you. The argument that you pass to the method is the string that you want to convert, and the piece of data that the method returns back to you is the converted value. Figure 3-12 illustrates this concept using the `int.Parse` method as an example.

**Figure 3-12** The `int.Parse` method



The following code sample shows how to use the `int.Parse` method to convert a control's `Text` property to an `int`. Assume that `hoursWorkedTextBox` is the name of a `TextBox` control.

```

1 // Declare an int variable to hold the hours worked.
2 int hoursWorked;
3
4 // Get the hours worked from the TextBox.
5 hoursWorked = int.Parse(hoursWorkedTextBox.Text);
  
```

Let's assume that the user has entered the value 40 into the `hoursWorkedTextBox` control. In line 5 of the code sample, on the right side of the `=` operator is the expression `int.Parse(hoursWorkedTextBox.Text)`. This expression calls the `int.Parse` method, passing the value of `hoursWorkedTextBox.Text` as an argument. Because the user has entered 40 into the `TextBox`, the string "40" is the value that is passed as the argument. The method converts the string "40" to the `int` value 40. The `int` value 40 is returned from the method and the `=` operator assigns it to the `hoursWorked` variable. Figure 3-13 illustrates this process.

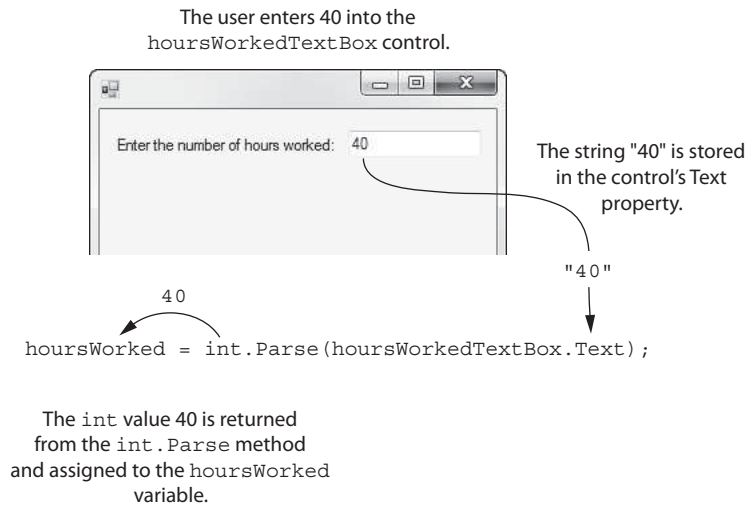
The following code sample demonstrates the `double.Parse` method. Assume that `temperatureTextBox` is the name of a `TextBox` control.

```

1 // Declare a double variable to hold the temperature.
2 double temperature;
3
4 // Get the temperature from the TextBox.
5 temperature = double.Parse(temperatureTextBox.Text);
  
```

Line 5 passes `temperatureTextBox.Text` as an argument to the `double.Parse` method. That value is converted to a `double`, returned from the `double.parse` method, and assigned to the `temperature` variable.

The following code sample demonstrates the `decimal.Parse` method. Assume that `moneyTextBox` is the name of a `TextBox` control.

**Figure 3-13** Converting TextBox input to an `int`

```

1 // Declare a decimal variable to hold an amount of money.
2 decimal money;
3
4 // Get an amount from the TextBox.
5 money = decimal.Parse(moneyTextBox.Text);

```

Line 5 passes `moneyTextBox.Text` as an argument to the `decimal.Parse` method. That value is converted to a `decimal`, returned from the `decimal.parse` method, and assigned to the `money` variable.



**NOTE:** If you look at the top of a form's source code in the code editor, you should see a directive that reads `using System;`. That directive is required for any program that uses the `Parse` methods.

### Invalid Conversions

The `Parse` methods work only if the string that is being converted contains a valid numeric value. If the string contains invalid characters or contains a number that cannot be converted to the specified data type, an error known as an exception occurs. An **exception** is an unexpected error that occurs while a program is running, causing the program to halt if the error is not properly dealt with.

For example, assume that `hoursWorked` is an `int` variable and `hoursWorkedTextBox` is a `TextBox` control. Suppose the user has entered `xyz` into the `TextBox` and the following statement executes:

```
hoursWorked = int.Parse(hoursWorkedTextBox.Text);
```

Obviously, the string "xyz" cannot be converted to an `int`, so an exception occurs. (When an exception occurs, programmers say an exception is "thrown.") Depending on how you execute the application, you will see one of the windows displayed in Figure 3-14 or Figure 3-15.

- If you see the window in Figure 3-14, you can stop the application by clicking the *Stop Debugging* button (■), or by pressing `(Shift) + (F5)`, or by clicking *Debug* and then *Stop Debugging*.
- When you see the window shown in Figure 3-15, in most situations you should click the *Quit* button to stop the application.

Figure 3-14 Exception reported

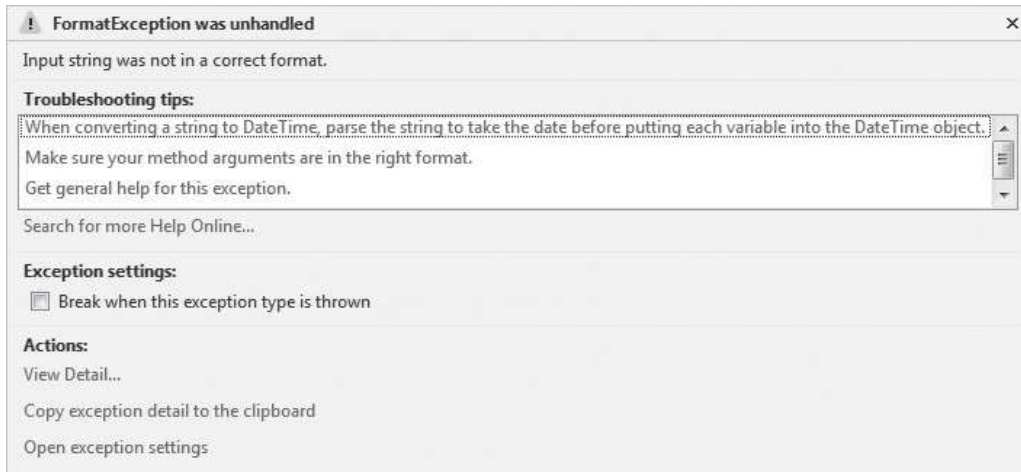
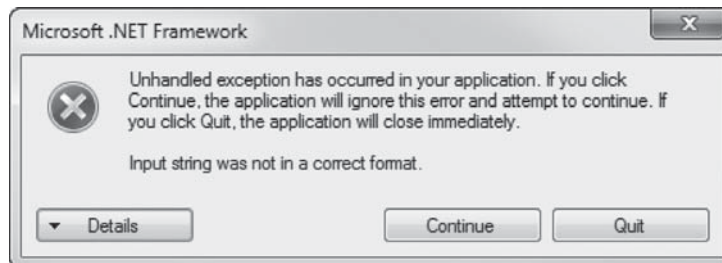


Figure 3-15 Exception reported



Later in this chapter you will learn how to catch errors like this and prevent the program from halting.

## Displaying Numeric Values

Suppose an application has a `decimal` variable named `grossPay` and a Label control named `grossPayLabel`. You want to display the variable's value in the Label control. To accomplish this, you must somehow get the value of the `grossPay` variable into the `grossPayLabel` control's `Text` property. The following assignment statement will not work, however:

```
grossPayLabel.Text = grossPay; ← ERROR!
```

You cannot assign a numeric value to a control's `Text` property because only strings can be assigned to the `Text` property. If you want to display the value of a numeric variable in a Label control, you have to convert the variable's value to a string.

Luckily, all variables have a **ToString** method that you can call to convert the variable's value to a string. You call the `Tostring` method using the following general format:

```
variableName.ToString()
```

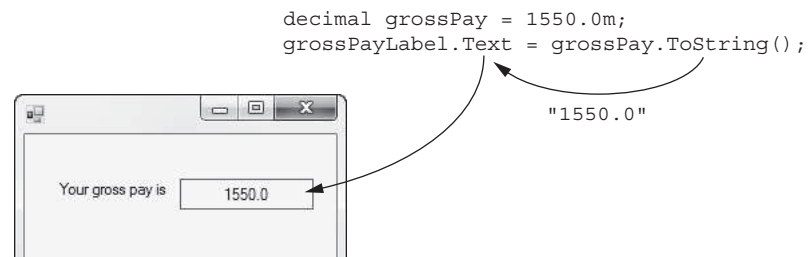
In the general format, `variableName` is the name of any variable. The expression returns the variable's value as a string. Here is a code sample that demonstrates:

```
decimal grossPay = 1550.0m;
grossPayLabel.Text = grossPay.ToString();
```

The first statement declares a `decimal` variable named `grossPay` initialized with the value 1,550.0. In the second statement, the expression on the right side of the `=` operator calls the `grossPay` variable's `ToString` method. The method returns the string

"1550.0". The = operator then assigns the string "1550.0" to the `grossPayLabel` control's `Text` property. As a result, the value `1550.0` is displayed in the `grossPayLabel` control. This process is illustrated in Figure 3-16.

**Figure 3-16** Displaying numeric data in a Label control



You must also convert a numeric variable to a `string` before passing it to the `MessageBox.Show` method. The following example shows how an `int` variable's value can be converted to a `string` and displayed in a message box:

```
int myNumber = 123;
MessageBox.Show(myNumber.ToString());
```

The first statement declares an `int` variable named `myNumber`, initialized with the value 123. In the second statement the following takes place:

- The `myNumber` variable's `ToString` method is called. The method returns the string "123".
- The string "123" is passed to the `MessageBox.Show` method. As a result, the value 123 is displayed in a message box.

## Implicit String Conversion with the + Operator

In this chapter you've learned that the + operator has two uses: string concatenation and numeric addition. If you write an expression using the + operator and both operands are strings, the + operator concatenates the strings. If both operands are numbers of compatible types, then the + operator adds the two numbers. But what happens if one operand is a string and the other operand is a number? The number will be implicitly converted to a string, and both operands will be concatenated. Here's an example:

```
int idNumber = 1044;
string output = "Your ID number is " + idNumber;
```

In the second statement, the `string` variable `output` is initialized with the string "Your ID number is 1044". Here is another example:

```
double testScore = 88.5;
MessageBox.Show("Your test score is " + testScore);
```

The second statement displays a message box showing the string "Your test score is 88.5".

In Tutorial 3-2 you will use some of the techniques discussed in this section. You will create an application that reads numeric input from `TextBox` controls, and displays numeric output in a `Label` control.



VideoNote

### Tutorial 3-2: Calculating Fuel Economy



## Tutorial 3-2: Calculating Fuel Economy

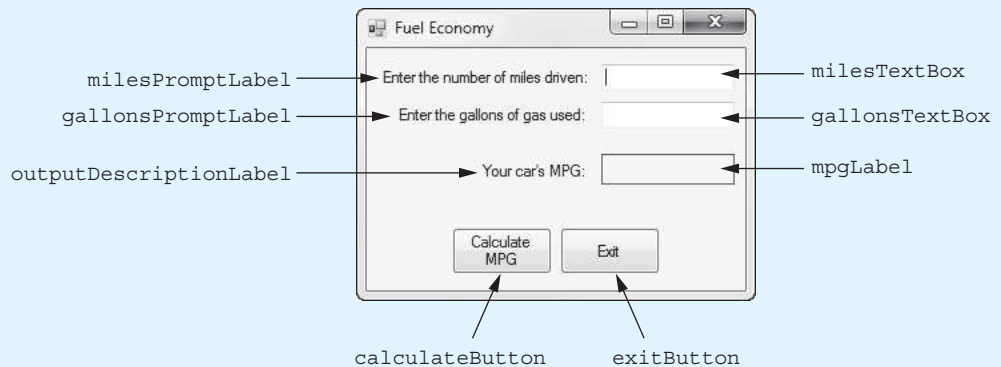
In the United States, a car's fuel economy is measured in miles per gallon, or MPG. You use the following formula to calculate a car's MPG:

$$MPG = \text{Miles driven} \div \text{Gallons of gas used}$$

In this tutorial you will create an application that lets the user enter the number of miles he or she has driven and the gallons of gas used. The application will calculate and display the car's MPG.

Figure 3-17 shows the application's form, with the names of all the controls. When the application runs, the user enters the number of miles driven into the `milesTextBox` control and the gallons of gas used into the `gallonsTextBox` control. When the user clicks the `calculateButton` control, the application calculates the car's MPG and displays the result in the `mpgLabel` control. The `exitButton` control closes the application's form.

**Figure 3-17** The *Fuel Economy* form



**Step 1:** Start Visual Studio (or Visual Studio Express) and begin a new Windows Forms Application project named *Fuel Economy*.

**Step 2:** Set up the application's form as shown in Figure 3-17. Notice that the form's Text property is set to *Fuel Economy*. The names of the controls are shown in the figure. As you place each of the controls on the form, refer to Table 3-8 for the relevant property settings.

**Step 3:** Once you have set up the form with its controls, you can create the Click event handlers for the Button controls. At the end of this tutorial, Program 3-2 shows the completed code for the form. You will be instructed to refer to Program 3-2 as you write the event handlers. (Remember, the line numbers that are shown in Program 3-2 are not part of the program. They are shown for reference only.)

In the *Designer*, double-click the `calculateButton` control. This opens the code editor, and you will see an empty event handler named `calculateButton_Click`. Complete the `calculateButton_Click` event handler by typing the code shown in lines 22–38 in Program 3-2.

Let's take a closer look at the code:

**Line 22:** This statement declares a `double` variable named `miles`. This variable is used to hold the number of miles driven.

**Line 23:** This statement declares a `double` variable named `gallons`. This variable is used to hold the number of gallons used.

**Table 3-8** Control property settings

| Control Name           | Control Type | Property Settings                                                                                                                                                 |
|------------------------|--------------|-------------------------------------------------------------------------------------------------------------------------------------------------------------------|
| milesPromptLabel       | Label        | <b>Text:</b> <i>Enter the number of miles driven:</i>                                                                                                             |
| gasPromptLabel         | Label        | <b>Text:</b> <i>Enter the gallons of gas used:</i>                                                                                                                |
| outputDescriptionLabel | Label        | <b>Text:</b> <i>Your car's MPG:</i>                                                                                                                               |
| milesTextBox           | TextBox      | No properties changed                                                                                                                                             |
| gallonsTextBox         | TextBox      | No properties changed                                                                                                                                             |
| mpgLabel               | Label        | <b>AutoSize:</b> False<br><b>BorderStyle:</b> FixedSingle<br><b>Text:</b> (The contents of the Text property have been erased.)<br><b>TextAlign:</b> MiddleCenter |
| calculateButton        | Button       | <b>Text:</b> <i>Calculate MPG</i>                                                                                                                                 |
| exitButton             | Button       | <b>Text:</b> <i>Exit</i>                                                                                                                                          |

**Line 24:** This statement declares a `double` variable named `mpg`. This variable is used to hold the MPG, which will be calculated.

**Line 28:** This statement converts the `milesTextBox` control's `Text` property to a `double` and assigns the result to the `miles` variable.

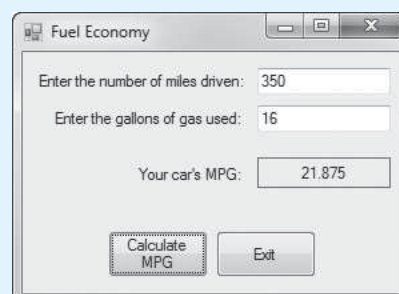
**Line 32:** This statement converts the `gallonsTextBox` control's `Text` property to a `double` and assigns the result to the `gallons` variable.

**Line 35:** This statement calculates MPG. It divides the `miles` variable by the `gallons` variable and assigns the result to the `mpg` variable.

**Line 38:** This statement converts the `mpg` variable to a string and assigns the result to the `mpgLabel` control's `Text` property. This causes the value of the `mpg` variable to be displayed in the `mpgLabel` control.

**Step 4:** Switch your view back to the *Designer* and double-click the `exitButton` control. In the code editor you will see an empty event handler named `exitButton_Click`. Complete the `exitButton_Click` event handler by typing the code shown in lines 43–44 in Program 3-2.

**Step 5:** Save the project. Then, press the `(F5)` key on the keyboard or click the *Start Debugging* button (🐞) on the toolbar to compile and run the application. Test the application by entering values into the `TextBoxes` and clicking the *Calculate MPG* button. The MPG should be displayed, similar to Figure 3-18. Click the *Exit* button and the form should close.

**Figure 3-18** The *Fuel Economy* application

**Program 3-2** Completed Form1 code for the *Fuel Economy* application

```
1 using System;
2 using System.Collections.Generic;
3 using System.ComponentModel;
4 using System.Data;
5 using System.Drawing;
6 using System.Linq;
7 using System.Text;
8 using System.Threading.Tasks;
9 using System.Windows.Forms;
10
11 namespace Fuel_Economy
12 {
13     public partial class Form1 : Form
14     {
15         public Form1()
16         {
17             InitializeComponent();
18         }
19
20         private void calculateButton_Click(object sender, EventArgs e)
21         {
22             double miles;    // To hold miles driven
23             double gallons;  // To hold gallons used
24             double mpg;     // To hold MPG
25
26             // Get the miles driven and assign it to
27             // the miles variable.
28             miles = double.Parse(milesTextBox.Text);
29
30             // Get the gallons used and assign it to
31             // the gallons variable.
32             gallons = double.Parse(gallonsTextBox.Text);
33
34             // Calculate MPG.
35             mpg = miles / gallons;
36
37             // Display the MPG in the mpgLabel control.
38             mpgLabel.Text = mpg.ToString();
39         }
40
41         private void exitButton_Click(object sender, EventArgs e)
42         {
43             // Close the form.
44             this.Close();
45         }
46     }
47 }
```



## Checkpoint

- 3.25 What method converts the string literal "40" to a value of the `int` data type?
- 3.26 Write a statement that converts each of the following string values to the `decimal` data type using the `decimal.Parse` method.
- "9.05"
  - `grandTotal`
  - "50"
  - `priceTextBox.Text`
- 3.27 Suppose an application has a `decimal` variable named `total` and a Label control named `totalLabel`. What will be the result when the following assignment statement is executed?
- ```
totalLabel.Text = total;
```
- 3.28 Write a statement that displays each of the following numeric variables in a message box.
- `grandTotal`
  - `highScore`
  - `sum`
  - `width`
- 3.29 Write a statement that will store the value of an `int` variable named `result` in the `Text` property of a Label control named `resultLabel`.

## 3.6

## Formatting Numbers with the ToString Method

**CONCEPT:** The `ToString` method can optionally format a number to appear in a specific way.

When you display large numbers, you usually want to format them with commas so they are easy to read. For example, 487,634,789.0 is easier to read than 487634789.0. Also, when you display amounts of money, you usually want to round them to two decimal places and display a currency symbol, such as a dollar sign (\$).

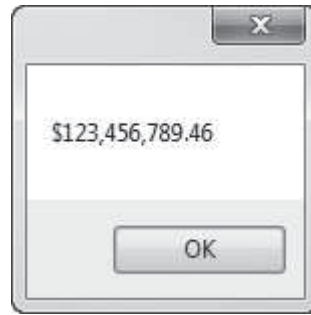
When you call the `ToString` method, you can optionally pass a formatting string as an argument to the method. The **formatting string** indicates that you want the number to appear formatted in a specific way when it is returned as a string from the method. For example, when you pass the formatting string "c" to the `ToString` method, the number is returned formatted as currency. Assuming that you are in the United States, numbers formatted as currency are preceded by a dollar sign (\$), are rounded to two decimal places, and have comma separators inserted as necessary. The following code sample demonstrates:

```
decimal amount = 123456789.45678m;  
MessageBox.Show(amount.ToString("c"));
```

Notice in the second statement that the "c" formatting string is passed to the `amount` variable's `ToString` method. The message box that the statement displays appears as shown in Figure 3-19.

There are several other format strings that you can use with the `ToString` method, and each produces a different type of formatting. Table 3-9 shows a few of them.



**Figure 3-19** A number formatted as currency**Table 3-9** A few of the formatting strings

Format String	Description
"N" or "n"	Number format
"F" or "f"	Fixed-point scientific format
"E" or "e"	Exponential scientific format
"C" or "c"	Currency format
"P" or "p"	Percent format

## Number Format

Number format ("n" or "N") displays numeric values with comma separators and a decimal point. By default, two digits display to the right of the decimal point. Negative values are displayed with a leading minus sign. An example is  $-2,345.67$ .

## Fixed-Point Format

Fixed-point format ("f" or "F") displays numeric values with no thousands separator and a decimal point. By default, two digits display to the right of the decimal point. Negative values are displayed with a leading minus (-) sign. An example is  $-2345.67$ .

## Exponential Format

Exponential format ("e" or "E") displays numeric values in scientific notation. The number is displayed with a single digit to the left of the decimal point. The letter e appears in front of the exponent, and the exponent has a leading + or - sign. By default, six digits display to the right of the decimal point, and a leading minus sign is used if the number is negative.

An example is  $-2.345670e+003$ .

## Currency Format

Currency format ("c" or "C") displays a leading currency symbol (such as \$), digits, comma separators, and a decimal point. By default, two digits display to the right of the decimal point. Negative values are surrounded by parentheses. An example of a negative value is  $($2,345.67)$ .

## Using Percent Format

Percent format ("p" or "P") causes the number to be multiplied by 100 and displayed with a trailing space and % sign. By default, two digits display to the right of the decimal

point. Negative values are displayed with a leading minus sign. For example, the number 0.125 would be formatted as 12.5 % and the number -0.2345 would be formatted as -23.45 %.

## Specifying the Precision

Each numeric format string can optionally be followed by an integer that indicates how many digits to display after the decimal point. For example, the format "n3" displays three digits after the decimal point. Table 3-10 shows a variety of numeric formatting examples, based on the North American locale.

**Table 3-10** Numeric formatting examples (North American locale)

Number	Format String	ToString( ) Return Value
12.3	"n3"	12.300
12.348	"n2"	12.35
1234567.1	"N"	1,234,567.10
123456.0	"f2"	123456.00
123456.0	"e3"	1.235e+005
.234	"P"	23.40 %
-1234567.8	"C"	(\$1,234,567.80)

## Rounding

Rounding can occur when the number of digits you have specified after the decimal point in the format string is smaller than the precision of the numeric value. Suppose, for example, that the value 1.235 were displayed with a format string of "n2". Then the displayed value would be 1.24. If the next digit after the last displayed digit is 5 or higher, the last displayed digit is rounded *away from zero*. Table 3-11 shows examples of rounding using a format string of "n2".

**Table 3-11** Rounding examples using the "n2" display format string

Number	Formatted As
1.234	1.23
1.235	1.24
1.238	1.24
-1.234	-1.23
-1.235	-1.24
-1.238	-1.24

## Using Leading Zeros with Integer Values

You can use the "d" or "D" formatting strings with integers to specify the minimum width for displaying the number. Leading zeros are inserted if necessary. Table 3-12 shows examples.

In Tutorial 3-3 you will create an application that uses currency formatting to display a dollar amount.

**Table 3-12** Formatting integers using the "d" or "D" formatting strings

Integer Value	Format String	Formatted As
23	"d"	23
23	"d4"	0023
1	"d2"	01



**Tutorial 3-3:**  
Creating the *Sale Price Calculator* Application with Currency Formatting



### Tutorial 3-3: Creating the *Sale Price Calculator* Application with Currency Formatting

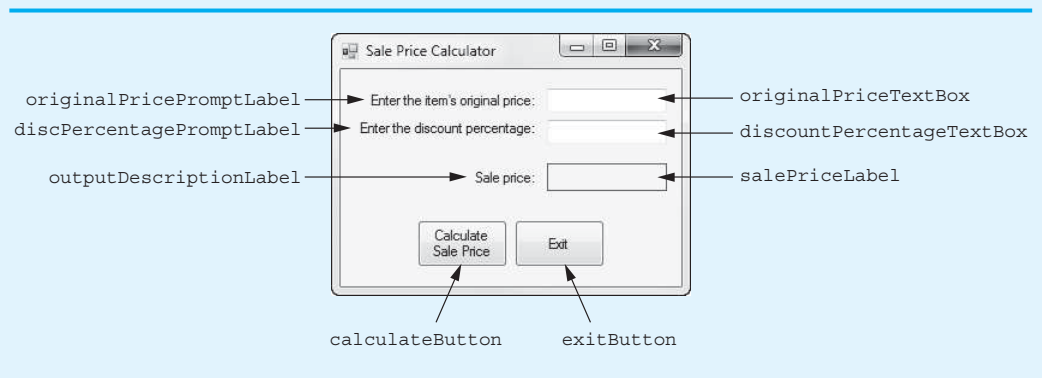
If you are writing a program that works with a percentage, you have to make sure that the percentage's decimal point is in the correct location before doing any math with the percentage. This is especially true when the user enters a percentage as input. Most users will enter the number 50 to mean 50 percent, 20 to mean 20 percent, and so forth. Before you perform any calculations with such a percentage, you have to divide it by 100 to move its decimal point to the left two places.

Suppose a retail business is planning to have a storewide sale in which the prices of all items will be reduced by a specified percentage. In this tutorial you will create an application to calculate the sale price of an item after the discount is subtracted. Here is the algorithm, expressed as pseudocode:

1. Get the original price of the item.
2. Get the discount percentage. (For example, 20 is entered for 20 percent.)
3. Divide the percentage amount by 100 to move the decimal point to the correct location.
4. Multiply the percentage by the original price. This is the amount of the discount.
5. Subtract the discount from the original price. This is the sale price.
6. Display the sale price.

Figure 3-20 shows the application's form, with the names of all the controls. When the application runs, the user enters an item's original price into the `originalPriceTextBox` control and the discount percentage into the `discountPercentageTextBox` control. When the user clicks the `calculateButton` control, the application calculates the item's sale price and displays the result in the `salePriceLabel` control. The `exitButton` control closes the application's form.

**Figure 3-20** The *Sale Price Calculator* form



- Step 1:** Start Visual Studio (or Visual Studio Express) and begin a new Windows Forms Application project named *Sale Price Calculator*.
- Step 2:** Set up the application's form, as shown in Figure 3-20. Notice that the form's Text property is set to *Sale Price Calculator*. The names of the controls are shown in the figure. As you place each of the controls on the form, refer to Table 3-13 for the relevant property settings.

**Table 3-13** Control property settings

Control Name	Control Type	Property Settings
originalPricePromptLabel	Label	<b>Text:</b> <i>Enter the item's original price:</i>
discPercentagePromptLabel	Label	<b>Text:</b> <i>Enter the discount percentage:</i>
outputDescriptionLabel	Label	<b>Text:</b> <i>Sale price:</i>
originalPriceTextBox	TextBox	No properties changed
discountPercentageTextBox	TextBox	No properties changed
salePriceLabel	Label	<b>AutoSize:</b> False <b>BorderStyle:</b> FixedSingle <b>Text:</b> (The contents of the Text property have been erased.) <b>TextAlign:</b> MiddleCenter
calculateButton	Button	<b>Text:</b> <i>Calculate Sale Price</i>
exitButton	Button	<b>Text:</b> <i>Exit</i>

- Step 3:** Once you have set up the form with its controls, you can create the Click event handlers for the Button controls. At the end of this tutorial, Program 3-3 shows the completed code for the form. You will be instructed to refer to Program 3-3 as you write the event handlers. (Remember, the line numbers that are shown in Program 3-3 are not part of the program. They are shown for reference only.)

In the *Designer*, double-click the `calculateButton` control. This will open the code editor, and you will see an empty event handler named `calculateButton_Click`. Complete the `calculateButton_Click` event handler by typing the code shown in lines 22–43 in Program 3-3.

Let's take a closer look at the code:

**Line 22:** This statement declares a decimal variable named `originalPrice`. This variable will hold the item's original price.

**Line 23:** This statement declares a decimal variable named `discountPercentage`. This variable will hold the discount percentage.

**Line 24:** This statement declares a decimal variable named `discountAmount`. This variable will hold the amount of discount that will be taken from the item's original price. This amount will be calculated.

**Line 25:** This statement declares a decimal variable named `salePrice`. This variable will hold the item's sale price. This amount will be calculated.

**Line 28:** This statement converts the `originalPriceTextBox` control's Text property to a decimal and assigns the result to the `originalPrice` variable.

**Line 31:** This statement converts the `discountPercentageTextBox` control's `Text` property to a decimal and assigns the result to the `discountPercentage` variable.

**Line 34:** This statement divides `discountPercentage` by 100 and stores the result back in `discountPercentage`. This moves the decimal point in the `discountPercentage` variable to the left two places.

**Line 37:** This statement calculates the amount of the discount. It multiplies `originalPrice` by `discountPercentage` and assigns the result to `discountAmount`.

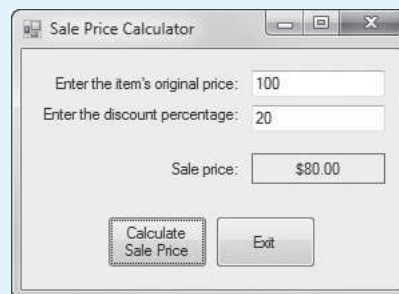
**Line 40:** This statement calculates the item's sale price. It subtracts the `discountAmount` variable from the `originalPrice` variable and assigns the result to the `salePrice` variable.

**Line 43:** This statement displays the item's sale price as a currency amount. It converts the `salePrice` variable to a string and assigns the result to the `salePriceLabel` control's `Text` property. Notice that the format string "c" is passed to the `salePrice` variable's `ToString` method.

**Step 4:** Switch your view back to the *Designer* and double-click the `exitButton` control. In the code editor you will see an empty event handler named `exitButton_Click`. Complete the `exitButton_Click` event handler by typing the code shown in lines 48–49 in Program 3-3.

**Step 5:** Save the project. Then, press the `(F5)` key on the keyboard or click the *Start Debugging* button (🐞) on the toolbar to compile and run the application. Test the application by entering values into the `TextBoxes` and clicking the *Calculate Sale Price* button. The sale price is displayed, similar to Figure 3-21. Click the *Exit* button and the form closes.

**Figure 3-21** The *Sale Price Calculator* application



**Program 3-3** Completed `Form1` code for the *Sale Price Calculator* application

```

1 using System;
2 using System.Collections.Generic;
3 using System.ComponentModel;
4 using System.Data;
5 using System.Drawing;
6 using System.Linq;
7 using System.Text;
8 using System.Threading.Tasks;
9 using System.Windows.Forms;
10
11 namespace Sale_Price_Calculator

```

```
12 {
13     public partial class Form1 : Form
14     {
15         public Form1()
16         {
17             InitializeComponent();
18         }
19
20         private void calculateButton_Click(object sender, EventArgs e)
21         {
22             decimal originalPrice;        // The item's original price
23             decimal discountPercentage;    // The discount percentage
24             decimal discountAmount;       // The amount of discount
25             decimal salePrice;            // The item's sale price
26
27             // Get the item's original price.
28             originalPrice = decimal.Parse(originalPriceTextBox.Text);
29
30             // Get the discount percentage.
31             discountPercentage = decimal.Parse(discountPercentageTextBox.Text);
32
33             // Move the percentage's decimal point left two spaces.
34             discountPercentage = discountPercentage / 100;
35
36             // Calculate the amount of the discount.
37             discountAmount = originalPrice * discountPercentage;
38
39             // Calculate the sale price.
40             salePrice = originalPrice - discountAmount;
41
42             // Display the sale price.
43             salePriceLabel.Text = salePrice.ToString("c");
44         }
45
46         private void exitButton_Click(object sender, EventArgs e)
47         {
48             // Close the form.
49             this.Close();
50         }
51     }
52 }
```

 **Checkpoint**

- 3.30 Write a programming statement that displays the string value of a variable named salary in a message box using currency format.
- 3.31 The following variable names give an indication of the data each stores. For each variable, specify the format string that you think is most appropriate.
  - a. discountPercentage
  - b. atomicWeight
  - c. retailPrice
  - d. quantityPurchased
  - e. degreesKelvin

3.32 What value will be displayed in the message box when the following code segment is executed?

```
double apples = 12.0;
MessageBox.Show(apples.ToString("n0"));
```

3.33 Examine the following integer variables and specify the number of leading zeros to use with the `d` or `D` format strings so that all the numbers are equal in width.

```
int valueA = 234, valueB = 56, valueC = 7, valueD = 89123;
```

3.34 Write a programming statement that uses the `ToString` method of a variable named `millimeters` so that it displays a precision of four digits after the decimal point in fixed-point scientific format.

## 3.7 Simple Exception Handling

**CONCEPT:** An exception is an unexpected error that happens while a program is running. If an exception is not handled by the program, the program will abruptly halt.

An exception is an unexpected error that occurs while a program is running, causing the program to halt if the error is not properly dealt with. Exceptions are usually caused by circumstances that are beyond the programmer's control. For example, suppose the user has entered a value into a `TextBox`, and that value is expected to be a number. The program uses one of the `Parse` methods to convert the control's `Text` property to a numeric data type, but the string contains invalid characters and it cannot be converted. The `Parse` method cannot continue, so an exception occurs. (To use the proper terminology, we say that a method throws an exception when an unexpected error occurs and it cannot continue operating.)

Let's look at an example. If you have completed the *Fuel Economy* project from Tutorial 3-2, open it in Visual Studio and then either click the *Start Debugging* button (▶) or press **F5** to run the application. On the application's form, enter 300 for the number of miles driven and then enter a nonnumeric sequence of characters for the gallons of gas used. Figure 3-22 shows an example where the user has entered *wxyz*. Then, click the *Calculate MPG* button. Because the invalid string that you entered for the gallons of gas cannot be converted to a `double`, an exception is thrown. The application stops running and Visual Studio goes into a special mode known as **break mode**. The window shown in Figure 3-23 is displayed, and the line of code that was executing when the exception was thrown is highlighted.

**Figure 3-22** Invalid data entered for gallons

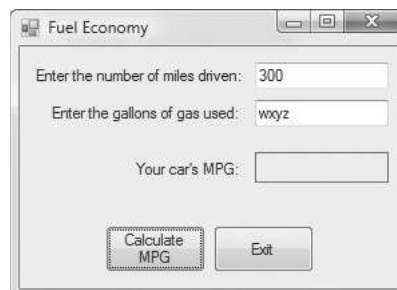
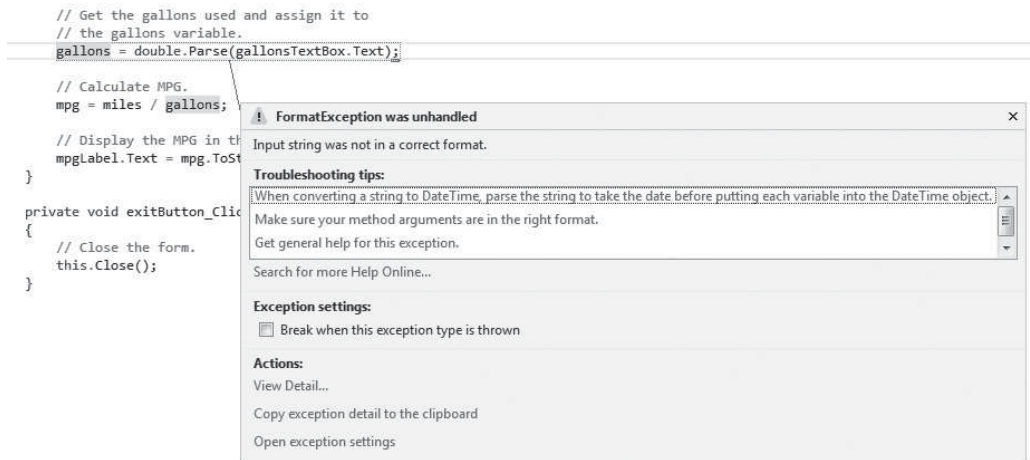


Figure 3-23 Exception reported



The exception window that is shown in Figure 3-23 displays a lot of information, but if you look at the line just below the window's title bar, you see the message *Input string was not in a correct format*. That is a description of what happened to cause the exception. To get out of break mode, click the *Stop Debugging* button (■), or press **(Shift) + (F5)**. Visual Studio then returns to its normal mode.

## Handling Exceptions

C#, like most modern programming languages, allows you to write code that responds to exceptions when they are thrown and prevents the program from abruptly crashing. Such code is called an **exception handler**, and is written with the **try-catch statement**. There are several ways to write a try-catch statement, but the following general format is the simplest variation:

```
try
{
    statement;
    statement;
    etc.
}
catch
{
    statement;
    statement;
    etc.
}
```

First the key word **try** appears, followed by a group of one or more statements that appears inside a set of braces. This group of statements is known as a **try block**. One or more of the statements inside the try block can potentially throw an exception.

After the try block, a **catch clause** appears. The catch clause is followed by a group of one or more statements enclosed inside a set of braces. This group of statements is known as a **catch block**.

When a try-catch statement executes, the statements in the try block are executed in the order that they appear. If a statement in the try block throws an exception, the program immediately jumps to the catch clause and executes the statements in the catch block. If all the statements in the try block execute with no exception, the catch block is skipped.



Let's see how a `try-catch` statement can be used in the *Fuel Economy* application. Here is a modified version of the application's `calculateButton_Click` event handler:

```

1 private void calculateButton_Click(object sender, EventArgs e)
2 {
3     try
4     {
5         double miles; // To hold miles driven
6         double gallons; // To hold gallons used
7         double mpg; // To hold MPG
8
9         // Get the miles driven and assign it to
10        // the miles variable.
11        miles = double.Parse(milesTextBox.Text);
12
13        // Get the gallons used and assign it to
14        // the gallons variable.
15        gallons = double.Parse(gallonsTextBox.Text);
16
17        // Calculate MPG.
18        mpg = miles / gallons;
19
20        // Display the MPG in the mpgLabel control.
21        mpgLabel.Text = mpg.ToString();
22    }
23    catch
24    {
25        // Display an error message.
26        MessageBox.Show("Invalid data was entered.");
27    }
28 }

```

When you write a `try-catch` statement, you put all the code that might throw an exception inside the `try` block. In this version of the event handler, the `try` block appears in lines 5–21. (In this example, we have put all the statements that previously appeared in the event handler inside the `try` block.) If any statement inside the `try` block throws an exception, the program will immediately jump to the `catch` clause in line 23. Then, the statements in the `catch` block (lines 25–26) will execute.

Let's say that the application is running and the user enters invalid input into the `milesTextBox` control. When the event handler executes, the statement in line 11 throws an exception because the `double.Parse` method is not able to convert the control's `Text` property to a `double`. The program will immediately jump to the `catch` clause in line 23 and then execute the statements inside the `catch` block. Line 26 displays a message box with an error message. Figure 3-24 illustrates this process.

On the other hand, if all the statements inside the `try` block execute and no exceptions are thrown, the `catch` block will be skipped.

## Displaying an Exception's Default Error Message

When an exception is thrown, an object known as an **exception object** is created in memory. The exception object has various properties that contain data about the exception. When you write a `catch` clause, you can optionally assign a name to the exception object, as shown here:

```
catch (Exception ex)
```

The expression that appears inside the parentheses specifies that we are assigning the name `ex` to the exception object. (There is nothing special about the name `ex`. That is simply the name that we've chosen for the examples. You can use any name that you wish.)

**Figure 3-24** Handling an exception

```

private void calculateButton_Click(object sender, EventArgs e)
{
    try
    {
        double miles;    // To hold miles driven
        double gallons; // To hold gallons used
        double mpg;     // To hold MPG

        // Get the miles driven and assign it to
        // the miles variable.
        miles = double.Parse(milesTextBox.Text);

        // Get the gallons used and assign it to
        // the gallons variable.
        gallons = double.Parse(gallonsTextBox.Text);

        // Calculate MPG.
        mpg = miles / gallons;

        // Display the MPG in the mpgLabel control.
        mpgLabel.Text = mpg.ToString();
    }
    catch
    {
        // Display an error message.
        MessageBox.Show("Invalid data was entered.");
    }
}

```

If this statement throws an exception...

The program jumps to the catch clause and executes the statements in the catch block.

Inside the catch block, we can use the name `ex` to access the exception object's properties. One of these is the `Message` property, which contains the exception's default error message. The following code shows how this can be done. This is another modification of the *Fuel Economy* project's `calculateButton_Click` event handler.

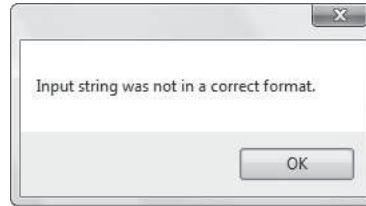
```

1 private void calculateButton_Click(object sender, EventArgs e)
2 {
3     try
4     {
5         double miles;    // To hold miles driven
6         double gallons; // To hold gallons used
7         double mpg;     // To hold MPG
8
9         // Get the miles driven and assign it to
10        // the miles variable.
11        miles = double.Parse(milesTextBox.Text);
12
13        // Get the gallons used and assign it to
14        // the gallons variable.
15        gallons = double.Parse(gallonsTextBox.Text);
16
17        // Calculate MPG.
18        mpg = miles / gallons;
19
20        // Display the MPG in the mpgLabel control.
21        mpgLabel.Text = mpg.ToString();
22    }
23    catch (Exception ex)
24    {
25        // Display the default error message.
26        MessageBox.Show(ex.Message);
27    }
28 }

```

The statement in line 26 simply passes the exception object's `Message` property to the `MessageBox.Show` method. This causes the default error message to be displayed in a message box. Figure 3-25 shows an example of the message that is displayed as a result of the user entering invalid input for either the `milesTextBox` or the `gallonsTextBox` controls.

**Figure 3-25** A message box showing an exception's default error message



In Tutorial 3-4 you create an application that uses a `try-catch` statement to handle exceptions that are thrown when the user enters invalid data into a `TextBox` control.



**Tutorial 3-4:**  
Creating the *Test Average* Application with Exception Handling

### Tutorial 3-4: Creating the *Test Average* Application with Exception Handling

Determining the average of a group of values is a simple calculation: You add all the values and then divide the sum by the number of values. Although this is a straightforward calculation, it is easy to make a mistake when writing a program that calculates an average. For example, let's assume that the variables `a`, `b`, and `c` each hold a value and we want to calculate the average of those values. If we are careless, we might write a statement such as the following to perform the calculation:

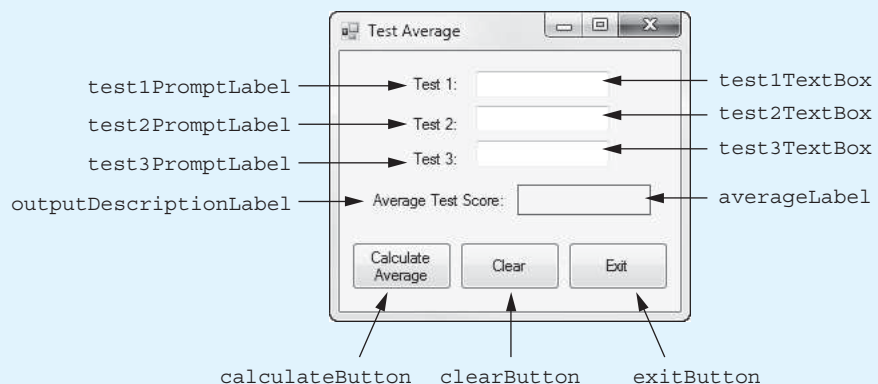
```
average = a + b + c / 3.0;
```

Can you see the error in this statement? When it executes, the division will take place first. The value in `c` will be divided by 3, and then the result will be added to `a + b`. That is not the correct way to calculate an average. To correct this error we need to put parentheses around `a + b + c`, as shown here:

```
average = (a + b + c) / 3.0;
```

In this tutorial you will create an application that calculates the average of three test scores. Figure 3-26 shows the application's form, with the names of all the controls.

**Figure 3-26** The *Test Average* form



the application runs, the user will enter the test scores into the `TextBox` controls. When the user clicks the `calculateButton` control, the application will calculate the average test score and display the result in the `averageLabel` control. The `clearButton` control will clear the contents of the `TextBoxes` and the `averageLabel` control. The `exitButton` control closes the application's form.

- Step 1:** Start Visual Studio (or Visual Studio Express) and begin a new Windows Forms Application project named *Test Average*.
- Step 2:** Set up the application's form as shown in Figure 3-26. Notice that the form's `Text` property is set to *Test Average*. The names of the controls are shown in the figure. As you place each of the controls on the form, refer to Table 3-14 for the relevant property settings.

**Table 3-14** Control property settings

Control Name	Control Type	Property Settings
<code>test1PromptLabel</code>	Label	<b>Text:</b> <i>Test 1:</i>
<code>test2PromptLabel</code>	Label	<b>Text:</b> <i>Test 2:</i>
<code>test3PromptLabel</code>	Label	<b>Text:</b> <i>Test 3:</i>
<code>outputDescriptionLabel</code>	Label	<b>Text:</b> <i>Average Test Score:</i>
<code>test1TextBox</code>	TextBox	No properties changed
<code>test2TextBox</code>	TextBox	No properties changed
<code>test3TextBox</code>	TextBox	No properties changed
<code>averageLabel</code>	Label	<b>AutoSize:</b> False <b>BorderStyle:</b> FixedSingle <b>Text:</b> (The contents of the <code>Text</code> property have been erased.) <b>TextAlign:</b> MiddleCenter
<code>calculateButton</code>	Button	<b>Text:</b> <i>Calculate Sale Price</i>
<code>clearButton</code>	Button	<b>Text:</b> <i>Clear</i>
<code>exitButton</code>	Button	<b>Text:</b> <i>Exit</i>

- Step 3:** Once you have set up the form with its controls, you can create the Click event handlers for the Button controls. At the end of this tutorial, Program 3-4 shows the completed code for the form. You will be instructed to refer to Program 3-4 as you write the event handlers. (Remember, the line numbers that are shown in Program 3-4 are not part of the program. They are shown for reference only.)

In the *Designer*, double-click the `calculateButton` control. This will open the code editor, and you will see an empty event handler named `calculateButton_Click`. Complete the `calculateButton_Click` event handler by typing the code shown in lines 22–45 in Program 3-4. Let's take a closer look at the code:

**Line 22:** This is the beginning of a try-catch statement. The try block appears in lines 24–39, and the catch block appears in lines 43–44.

**Lines 24–27:** These statements declare the following `double` variables: `test1`, `test2`, `test3`, and `average`. The variables will hold the three test scores and the average test score.

**Line 30:** This statement converts the `test1TextBox` control's `Text` property to a `double` and assigns the result to the `test1` variable.

**Line 31:** This statement converts the `test2TextBox` control's `Text` property to a `double` and assigns the result to the `test2` variable.

**Line 32:** This statement converts the `test3TextBox` control's `Text` property to a `double` and assigns the result to the `test3` variable.

**Line 35:** This statement calculates the average of the `test1`, `test2`, and `test3` variables and assigns the result to the `average` variable.


**Line 39:** This statement converts the `average` variable to a string and assigns the result to the `averageLabel` control's `Text` property. Notice that the `"n1"` format string is passed as an argument to the `Tostring` method. This causes the number to be rounded to one decimal point.

**Step 4:** Switch your view back to the *Designer* and double-click the `clearButton` control. In the code editor you will see an empty event handler named `clearButton_Click`. Complete the `clearButton_Click` event handler by typing the code shown in lines 50–54 in Program 3-4.

**Lines 51–53:** Each of these statements assigns an empty string (`""`) to the `Text` property of one of the `TextBox` controls. When these statements have finished executing, the `TextBox` controls appear empty.

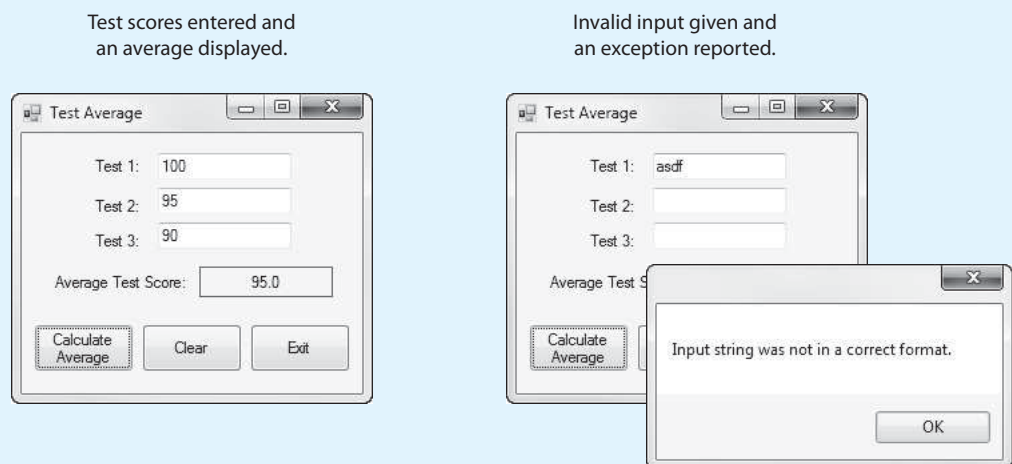
**Line 54:** This statement assigns an empty string (`""`) to the `averageLabel` control's `Text` property. After the statement has executed, the label appears empty.

**Step 5:** Switch your view back to the *Designer* and double-click the `exitButton` control. In the code editor you will see an empty event handler named `exitButton_Click`. Complete the `exitButton_Click` event handler by typing the code shown in lines 59–60 in Program 3-4.

**Step 6:** Save the project. Then, press the `[F5]` key on the keyboard or click the *Start Debugging* button () on the toolbar to compile and run the application.

First, test the application by entering valid numeric values into the `TextBox`s and clicking the *Calculate Average* button. A test average should be displayed, similar to the image shown on the left in Figure 3-27.

**Figure 3-27** The *Test Average* application



Next, click the *Clear* button to clear the TextBoxes and the average. Then enter a nonnumeric value for test 1, and click the *Calculate Average* button. An exception will be thrown, and you should see the message box shown in the image on the right in Figure 3-27.

Continue to test the application as you wish. When you are finished, click the *Exit* button and the form should close.

---

**Program 3-4** Completed Form1 code for the *Test Average* application

```
1 using System;
2 using System.Collections.Generic;
3 using System.ComponentModel;
4 using System.Data;
5 using System.Drawing;
6 using System.Linq;
7 using System.Text;
8 using System.Threading.Tasks;
9 using System.Windows.Forms;
10
11 namespace Test_Average
12 {
13     public partial class Form1 : Form
14     {
15         public Form1()
16         {
17             InitializeComponent();
18         }
19
20         private void calculateButton_Click(object sender, EventArgs e)
21         {
22             try
23             {
24                 double test1;    // To hold test score #1
25                 double test2;    // To hold test score #2
26                 double test3;    // To hold test score #3
27                 double average;  // To hold the average test score
28
29                 // Get the three test scores.
30                 test1 = double.Parse(test1TextBox.Text);
31                 test2 = double.Parse(test2TextBox.Text);
32                 test3 = double.Parse(test3TextBox.Text);
33
34                 // Calculate the average test score.
35                 average = (test1 + test2 + test3) / 3.0;
36
37                 // Display the average test score, with
38                 // the output rounded to 1 decimal point.
39                 averageLabel.Text = average.ToString("n1");
40             }
41             catch (Exception ex)
42             {
43                 // Display the default error message.
44                 MessageBox.Show(ex.Message);
45             }
46         }
47
48         private void clearButton_Click(object sender, EventArgs e)
```

```

49     {
50         // Clear the input and output controls.
51         test1TextBox.Text = "";
52         test2TextBox.Text = "";
53         test3TextBox.Text = "";
54         averageLabel.Text = "";
55     }
56
57     private void exitButton_Click(object sender, EventArgs e)
58     {
59         // Close the form.
60         this.Close();
61     }
62 }
63 }

```

### Checkpoint

- 3.35 What can cause an application to throw an exception?
- 3.36 How do you get out of break mode when an exception is thrown?
- 3.37 What kind of code does the try block of a try-catch statement contain?
- 3.38 What causes the program to jump to the catch clause and execute the catch block of a try-catch statement?
- 3.39 How can you display the default error message when an exception is thrown?
- 3.40 Write a try-catch statement for an application that calculates the sum of two whole numbers and displays the result. The application uses two TextBox controls named value1TextBox and value2TextBox to gather the input and a Label control named sumLabel to display the result.

## 3.8 Using Named Constants

**CONCEPT:** A named constant is a name that represents a value that cannot be changed during the program's execution.

Assume that the following statement appears in a banking program that calculates data pertaining to loans:

```
amount = balance * 0.069;
```

In such a program, two potential problems arise. First, it is not clear to anyone other than the original programmer what 0.069 is. It appears to be an interest rate, but in some situations there are fees associated with loan payments. How can the purpose of this statement be determined without painstakingly checking the rest of the program?

The second problem occurs if this number is used in other calculations throughout the program and must be changed periodically. Assuming the number is an interest rate, what if the rate changes from 6.9 percent to 7.2 percent? The programmer would have to search through the source code for every occurrence of the number.

Both these problems can be addressed by using named constants. A **named constant** is a name that represents a value that cannot be changed during the program's execution. The following is an example of how you can declare a named constant in C#:

```
const double INTEREST_RATE = 0.129;
```

This statement declares a named constant named `INTEREST_RATE` initialized with the value 0.129. It looks like a regular variable declaration, except that the word `const` appears before the data type name and the name of the variable is written in uppercase characters. The keyword `const` is a qualifier that tells the compiler to make the variable read only. If a statement attempts to change the constant's value, an error will occur when the program is being compiled. When you declare a named constant, an initialization value is required.

It is not required that the constant name be written in uppercase letters, but many programmers prefer to write them this way so they are easily distinguishable from regular variable names. When you are reading a program's code and you see an uppercase identifier, you know instantly that it is a constant.



**NOTE:** Writing the names of constants in uppercase letters is traditional in many programming languages, and that practice is followed in this book. Within the C# community, some programmers adhere to this practice and some do not. In the classroom, you should use the naming convention that your instructor prefers.

An advantage of using named constants is that they make programs more self-explanatory. The statement

```
amount = balance * 0.069;
```

can be changed to read

```
amount = balance * INTEREST_RATE;
```

A new programmer can read the second statement and know what is happening. It is evident that `balance` is being multiplied by the interest rate. Another advantage to this approach is that widespread changes can easily be made to the program. Let's say the interest rate appears in a dozen different statements throughout the program. When the rate changes, the initialization value in the declaration of the named constant is the only value that needs to be modified. If the rate increases to 7.2 percent, the declaration can be changed to the following:

```
const double INTEREST_RATE = 0.072;
```

The new value of 0.072 will then be used in each statement that uses the `INTEREST_RATE` constant. In Tutorial 3-5 you will create an application that uses named constants.

## 3.9

## Declaring Variables as Fields

**CONCEPT:** A field is a variable that is declared at the class level. A field's scope is the entire class.

So far in this chapter, all the variables with which we have worked have been local variables. A local variable is declared inside a method and is visible only to statements in that method. Another type of variable is a **field**, which is a variable that is declared inside a



class but not inside of any method. A field's scope is the entire class, so when you declare a field, all the methods in the class can access the variable.

Typically, fields are declared at the top of a class declaration, before any methods. Figure 3-28 shows where you would write field declarations inside a form class. When you are about to write a field declaration, you can insert some blank lines after the class's opening brace (`{`) and write the field declaration in that space.

**Figure 3-28** Where to insert field declarations



Let's look at an example of a field declaration. Assume that the following statement appears inside a class declaration but not inside any methods. This statement declares an `int` field named `number`, initialized with the value `0`:

```
private int number = 0;
```

Field declarations are written like any other variable declaration, except that an access modifier usually appears before the data type. In this example, the keyword `private` is the access modifier. An **access modifier** specifies how a class member can be accessed by code outside the class. When you use the `private` access modifier in a field declaration, the field cannot be accessed by code outside the class. It can be accessed only by the methods that are inside the class.

It is a good programming practice to make fields `private` because `private` fields are hidden from code outside the class. That prevents code outside the class from changing the values of a class's fields and helps prevent bugs from creeping into your program. You will learn more about this in Chapter 10. Until then, if you declare fields in a class, you should get in the habit of making them `private`.



**NOTE:** There are other access modifiers, as you will learn later in this book. If you don't write an access modifier in a field declaration, C# will automatically make the field `private`. It is still a good idea to write the `private` access modifier because it makes it evident to anyone reading the code that the field is indeed `private`.

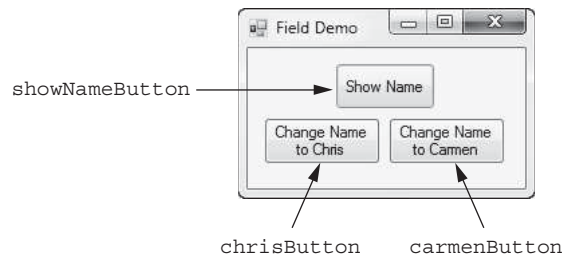
In the previous field-declaration example, the `number` field is initialized with the value 0. If a field is a variable of a numeric data type (such as `int`, `double`, or `decimal`), it will be initialized to 0 by default if you do not explicitly initialize it with a value. It is always a good idea to explicitly initialize a field, however, even if you want it to begin with the value 0. This clearly indicates the field's starting value for anyone reading the code.



**WARNING!** If you do not initialize a `string` field, it begins with a special value known as `null`. An error will occur if you attempt to use a `string` that is set to `null`.

In a form, fields are useful for storing pieces of data that must be shared among the form's event handlers. For example, in the *Chap03* folder of this book's student sample programs (available for download at [www.pearsonhighered.com/gaddis](http://www.pearsonhighered.com/gaddis)), you will find a project named *Field Demo*. Figure 3-29 shows the application's form, along with the names of the Button controls.

**Figure 3-29** The *Field Demo* form



Program 3-5 shows the `Form1` code. Notice that in line 16 a `string` variable named `name` is declared as a field and initialized with the value `"Charles"`. Next look at the button event handlers:

- In the `showNameButton_Click` event handler, line 25 displays a message box showing the value of the `name` variable.
- In the `chrisButton_Click` event handler, line 30 changes the value of the `name` variable to `"Chris"`.
- In the `carmenButton_Click` event handler, line 35 changes the value of the `name` variable to `"Carmen"`.

As you can see, all of the event handlers in the `Form1` class have access to the `name` variable. If you run the application and click the *Show Name* button, a message box will appear displaying *Charles*, which is the `name` field's initial value. If you click the *Change Name to Chris* button and then click the *Show Name* button, a message box will appear displaying *Chris*. If you click the *Change Name to Carmen* button and then click the *Show Name* button, a message box will appear displaying *Carmen*.

#### Program 3-5 `Form1` code for the *Field Demo* application

```

1 using System;
2 using System.Collections.Generic;
3 using System.ComponentModel;
4 using System.Data;
5 using System.Drawing;
6 using System.Linq;
7 using System.Text;
8 using System.Threading.Tasks;
9 using System.Windows.Forms;
10

```

```

11 namespace Field_Demo
12 {
13     public partial class Form1 : Form
14     {
15         // Declare a private field to hold a name.
16         private string name = "Charles";
17
18         public Form1()
19         {
20             InitializeComponent();
21         }
22
23         private void showNameButton_Click(object sender, EventArgs e)
24         {
25             MessageBox.Show(name);
26         }
27
28         private void chrisButton_Click(object sender, EventArgs e)
29         {
30             name = "Chris";
31         }
32
33         private void carmenButton_Click(object sender, EventArgs e)
34         {
35             name = "Carmen";
36         }
37     }
38 }

```

---

## The Lifetime of a Field in a Form Class

When you declare a field in a form class, the field's lifetime is the time during which the form exists. This means that the field will exist in memory as long as the form exists. This is different than the lifetime of a local variable, which exists only while the method in which it is declared is executing. Local variables come and go in memory, but a form's fields exist as long as the form exists.

You can see this in the *Field Demo* application. The name field is created in memory when the Form1 form is created, and it continues to exist as long as Form1 exists. When one of the event handlers stores a value in the field, that value remains in the field until it is changed again, perhaps by a different event handler. So, fields give you a way of storing values that must not disappear when a particular method ends.

## Precautions

Although fields make it easy to share data among the methods in a class, you should be careful about using them. The overuse of fields can make debugging a class's code difficult, especially if the class has many methods. If an incorrect value is being stored in a field, you will have to track down every statement in the class that accesses the field to determine where the incorrect value is coming from. In most cases, fields should be used only for data that must be shared among multiple methods and must continue to exist in memory when the methods are not executing.

## Constant Fields

A **constant field** is a field that cannot be changed by any statement in the class. An error will occur if the compiler finds a statement that tries to change the value of a constant

field. A constant field is declared with the `const` keyword and initialized with a value. Here is an example:

```
private const decimal INTEREST_RATE = 0.075m;
```

This statement declares a constant `decimal` field named `INTEREST_RATE`, initialized with the value `0.075`. Constant fields are typically used to represent unchanging values that are needed by many of a class's methods. For example, suppose a banking program uses a constant field to represent an interest rate. If the interest rate is used in several methods, it is easier to create a constant field, rather than a local named constant in each method. This also simplifies maintenance of the code. If the interest rate changes, only the declaration of the constant field has to be changed, instead of several local declarations.



**NOTE:** Because a constant field's value cannot be changed by other statements in the class, you do not have to worry about many of the potential debugging problems that are associated with the overuse of regular, nonconstant fields.

In Tutorial 3-5 you will create an application that uses a field in a form class to hold data, as well as constant fields to represent nonchanging values.



VideoNote

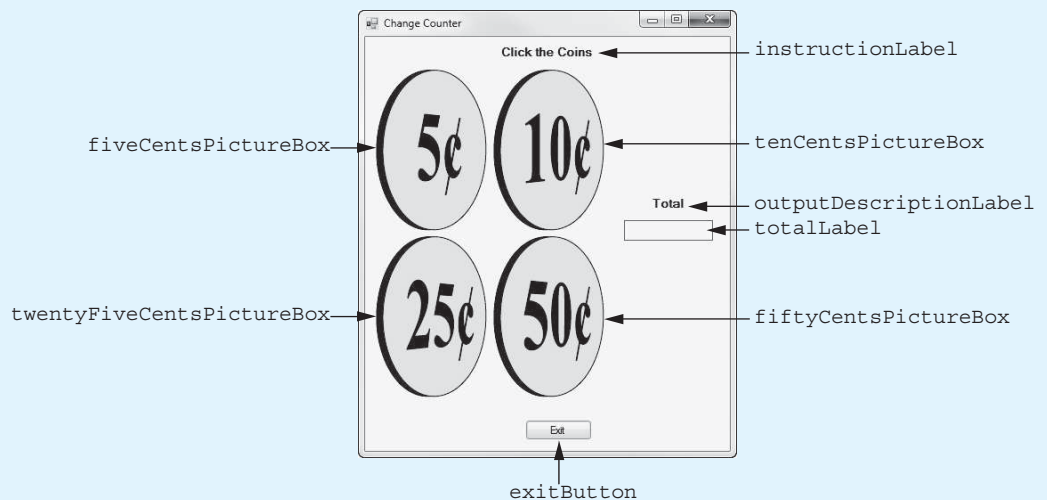
**Tutorial 3-5:**  
Creating  
the *Change  
Counter*  
Application



### Tutorial 3-5: Creating the *Change Counter* Application

In this tutorial you will create the *Change Counter* application. The application displays images of four coins, having the values 5 cents, 10 cents, 25 cents, and 50 cents. Each time the user clicks on a coin image, the value of that coin is added to a total, and the total is displayed. Figure 3-30 shows the application's form, with the names of all the controls.

**Figure 3-30** The *Change Counter* form



**Step 1:** Start Visual Studio (or Visual Studio Express) and begin a new Windows Forms Application project named *Sale Price Calculator*.

**Step 2:** Set up the application's form as shown in Figure 3-30. Notice that the form's Text property is set to *Change Counter*. The names of the controls are shown in

the figure. As you place each of the controls on the form, refer to Table 3-15 for the relevant property settings.

**Table 3-15** Control property settings

Control Name	Control Type	Property Settings
instructionLabel	Label	<b>Font:</b> Microsoft Sans Serif (Style: Bold, Size: 10 point) <b>Text:</b> <i>Click the Coins</i>
fiveCentsPictureBox	PictureBox	<b>Image:</b> Select and import the 5cents.png file from the <i>Chap02</i> folder of the Student Sample Programs. <b>SizeMode:</b> AutoSize
tenCentsPictureBox	PictureBox	<b>Image:</b> Select and import the 10cents.png file from the <i>Chap02</i> folder of the Student Sample Programs. <b>SizeMode:</b> AutoSize
twentyFiveCentsPictureBox	PictureBox	<b>Image:</b> Select and import the 25cents.png file from the <i>Chap02</i> folder of the Student Sample Programs. <b>SizeMode:</b> AutoSize
fiftyCentsPictureBox	PictureBox	<b>Image:</b> Select and import the 50cents.png file from the <i>Chap02</i> folder of the Student Sample Programs. <b>SizeMode:</b> AutoSize
outputDescriptionLabel	Label	<b>Font:</b> Microsoft Sans Serif (Style: Bold, Size: 10 point) <b>Text:</b> <i>Total</i>
totalLabel	Label	<b>AutoSize:</b> False <b>BorderStyle:</b> FixedSingle <b>Text:</b> (The contents of the Text property have been erased.) <b>TextAlign:</b> MiddleCenter
exitButton	Button	<b>Text:</b> <i>Exit</i>

**Step 3:** Once you have set up the form with its controls, you can begin writing code. At the end of this tutorial, Program 3-6 shows the completed code for the form. You will be instructed to refer to Program 3-6 as you write the form's code. (Remember, the line numbers that are shown in Program 3-6 are not part of the program. They are shown for reference only.)

First, you write the declarations for the fields. Switch your view to the code editor (right-click *Form1.cs* in the *Solution Explorer* and select *View Code* from the pop-up menu). Write the declarations shown in lines 16–23 in Program 3-6. Let's take a closer look at the code:

**Line 16:** This statement declares a constant `decimal` field named `FIVE_CENTS_VALUE`, initialized with the value 0.05. This constant represents the value of the 5-cent coin.

**Line 17:** This statement declares a constant `decimal` field named `TEN_CENTS_VALUE`, initialized with the value 0.10. This constant represents the value of the 10-cent coin.

**Line 18:** This statement declares a constant `decimal` field named `TWENTY_FIVE_CENTS_VALUE`, initialized with the value 0.25. This constant represents the value of the 25-cent coin.

**Line 19:** This statement declares a constant `decimal` field named `FIFTY_CENTS_VALUE`, initialized with the value 0.50. This constant represents the value of the 50-cent coin.

**Line 23:** This statement declares a `decimal` field named `total`, initialized with the value 0. This field is used to keep the total value of the coins that the user clicks.

**Step 4:** Now you can create the Click event handlers for the `PictureBox` controls. Switch your view back to the *Designer* and double-click the `fiveCentsPictureBox` control. This opens the code editor, and you will see an empty event handler named `fiveCentsPictureBox_Click`. Complete the `fiveCentsPictureBox_Click` event handler by typing the code shown in lines 32–36 in Program 3-6. Let's take a closer look at the code:

**Line 33:** This statement adds the value of the `FIVE_CENTS_VALUE` constant to the `total` field.

**Line 36:** This statement converts the `total` variable to a string and assigns the result to the `totalLabel` control's `Text` property. The "c" format string causes the number to be formatted as currency.

**Step 5:** Switch your view back to the *Designer* and double-click the `tenCentsPictureBox` control. This opens the code editor, and you will see an empty event handler named `tenCentsPictureBox_Click`. Complete the `tenCentsPictureBox_Click` event handler by typing the code shown in lines 41–45 in Program 3-6. Let's take a closer look at the code:

**Line 42:** This statement adds the value of the `TEN_CENTS_VALUE` constant to the `total` field.

**Line 45:** This statement converts the `total` variable to a string and assigns the result to the `totalLabel` control's `Text` property. The "c" format string causes the number to be formatted as currency.

**Step 6:** Switch your view back to the *Designer* and double-click the `twentyFiveCentsPictureBox` control. This opens the code editor, and you will see an empty event handler named `twentyFiveCentsPictureBox_Click`. Complete the `twentyFiveCentsPictureBox_Click` event handler by typing the code shown in lines 50–54 in Program 3-6. Let's take a closer look at the code:

**Line 51:** This statement adds the value of the `TWENTY_FIVE_CENTS_VALUE` constant to the `total` field.

**Line 54:** This statement converts the `total` variable to a string and assigns the result to the `totalLabel` control's `Text` property. The "c" format string causes the number to be formatted as currency.

**Step 7:** Switch your view back to the *Designer* and double-click the `fiftyCentsPictureBox` control. This opens the code editor, and you will see an empty event handler named `fiftyCentsPictureBox_Click`. Complete the `fiftyCentsPictureBox_Click` event handler by typing the code shown in lines 59–63 in Program 3-6. Let's take a closer look at the code:

**Line 60:** This statement adds the value of the `FIFTY_CENTS_VALUE` constant to the `total` field.

**Line 63:** This statement converts the `total` variable to a string and assigns the result to the `totalLabel` control's `Text` property. The "c" format string causes the number to be formatted as currency.

- Step 8:** Now you write the event handler for the *Exit* button. Switch your view back to the *Designer* and double-click the `exitButton` control. This opens the code editor, and you will see an empty event handler named `exitButton_Click`. Complete the `exitButton_Click` event handler by typing the code shown in lines 68–69 in Program 3-6.
- Step 9:** Save the project. Then, press the `[F5]` key on the keyboard or click the *Start Debugging* button (🐞) on the toolbar to compile and run the application. Test the application by clicking the coin images in any order you wish. The total shown on the form should update by the correct amount each time you click a coin. When you are finished, click the *Exit* button and the form should close.

---

**Program 3-6** Completed `Form1` code for the *Change Counter* application

```

1 using System;
2 using System.Collections.Generic;
3 using System.ComponentModel;
4 using System.Data;
5 using System.Drawing;
6 using System.Linq;
7 using System.Text;
8 using System.Threading.Tasks;
9 using System.Windows.Forms;
10
11 namespace Change_Counter
12 {
13     public partial class Form1 : Form
14     {
15         // Constant fields
16         const decimal FIVE_CENTS_VALUE = 0.05m;
17         const decimal TEN_CENTS_VALUE = 0.10m;
18         const decimal TWENTY_FIVE_CENTS_VALUE = 0.25m;
19         const decimal FIFTY_CENTS_VALUE = 0.50m;
20
21         // Field variable to hold the total,
22         // initialized with 0.
23         private decimal total = 0m;
24
25         public Form1()
26         {
27             InitializeComponent();
28         }
29
30         private void fiveCentsPictureBox_Click(object sender, EventArgs e)
31         {
32             // Add the value of 5 cents to the total.
33             total += FIVE_CENTS_VALUE;
34
35             // Display the total, formatted as currency.
36             totalLabel.Text = total.ToString("c");
37         }
38
39         private void tenCentsPictureBox_Click(object sender, EventArgs e)
40         {
41             // Add the value of 10 cents to the total.
42             total += TEN_CENTS_VALUE;
43

```

```

44         // Display the total, formatted as currency.
45         totalLabel.Text = total.ToString("c");
46     }
47
48     private void twentyFiveCentsPictureBox_Click(object sender, EventArgs e)
49     {
50         // Add the value of 25 cents to the total.
51         total += TWENTY_FIVE_CENTS_VALUE;
52
53         // Display the total, formatted as currency.
54         totalLabel.Text = total.ToString("c");
55     }
56
57     private void fiftyCentsPictureBox_Click(object sender, EventArgs e)
58     {
59         // Add the value of 50 cents to the total.
60         total += FIFTY_CENTS_VALUE;
61
62         // Display the total, formatted as currency.
63         totalLabel.Text = total.ToString("c");
64     }
65
66     private void exitButton_Click(object sender, EventArgs e)
67     {
68         // Close the form.
69         this.Close();
70     }
71 }
72 }

```

## Checkpoint

- 3.41 What are two advantages of using named constants?
- 3.42 Write a programming statement that declares a named constant for a 10 percent discount.
- 3.43 Where should you place field declarations in a program?
- 3.44 What access modifier should you use when declaring a field? Why?
- 3.45 How is the lifetime of a field different from the lifetime of a local variable?
- 3.46 Write a programming statement that declares a constant field for a 5.9 percent interest rate.

## 3.10 Using the Math Class

**CONCEPT:** The .NET Framework's `Math` class provides several methods for performing complex mathematical calculations.

The .NET Framework provides a class named `Math`, which contains numerous methods that are useful for performing advanced mathematical operations. Table 3-16 gives a summary of several of the `Math` class methods. (For a comprehensive list of all the methods



**Table 3-16** Many of the `Math` class methods

Math Class Method	Description
<code>Math.Abs(x)</code>	Returns the absolute value of <code>x</code> .
<code>Math.Acos(x)</code>	Returns the arccosine of <code>x</code> , <i>in radians</i> . The argument <code>x</code> is a <code>double</code> , and the value that is returned is a <code>double</code> .
<code>Math.Asin(x)</code>	Returns the arcsine of <code>x</code> , <i>in radians</i> . The argument <code>x</code> is a <code>double</code> , and the value that is returned is a <code>double</code> .
<code>Math.Atan(x)</code>	Returns the arctangent of <code>x</code> , <i>in radians</i> . The argument <code>x</code> is a <code>double</code> , and the value that is returned is a <code>double</code> .
<code>Math.Ceiling(x)</code>	Returns the least integer that is greater than or equal to <code>x</code> (a <code>decimal</code> or a <code>double</code> ).
<code>Math.Cos(x)</code>	Returns the cosine of <code>x</code> in radians. The argument <code>x</code> is a <code>double</code> , and the value that is returned is a <code>double</code> .
<code>Math.Exp(x)</code>	Returns $e^x$ . The argument <code>x</code> is a <code>double</code> , and the value that is returned is a <code>double</code> .
<code>Math.Floor(x)</code>	Returns the greatest integer that is less than or equal to <code>x</code> (a <code>decimal</code> or a <code>double</code> ).
<code>Math.Log(x)</code>	Returns the natural logarithm of <code>x</code> . The argument <code>x</code> is a <code>double</code> , and the value that is returned is a <code>double</code> .
<code>Math.Log10(x)</code>	Returns the base-10 logarithm of <code>x</code> . The argument <code>x</code> is a <code>double</code> , and the value that is returned is a <code>double</code> .
<code>Math.Max(x, y)</code>	Returns the greater of the two values <code>x</code> and <code>y</code> .
<code>Math.Min(x, y)</code>	Returns the lesser of the two values <code>x</code> and <code>y</code> .
<code>Math.Pow(x, y)</code>	Returns the value of <code>x</code> (a <code>double</code> ) raised to the power of <code>y</code> (also a <code>double</code> ). The value that is returned is a <code>double</code> .
<code>Math.Round(x)</code>	Returns the value of <code>x</code> (a <code>double</code> or a <code>decimal</code> ) rounded to the nearest integer.
<code>Math.Sin(x)</code>	Returns the sine of <code>x</code> in radians.
<code>Math.Sqrt(x)</code>	Returns the square root of <code>x</code> (a <code>double</code> ). The value that is returned is a <code>double</code> .
<code>Math.Tan(x)</code>	Returns the tangent of <code>x</code> in radians. The argument <code>x</code> is a <code>double</code> , and the value that is returned is a <code>double</code> .
<code>Math.Truncate(x)</code>	Returns the integer part of <code>x</code> (a <code>double</code> or a <code>decimal</code> ).

provided by the `Math` class and more details on any of the methods, just search for *Math class* in the MSDN help system.)

These methods typically accept one or more values as arguments, perform a mathematical operation using the arguments, and return the result. For example, the `Math.Pow` method raises a number to a power. Here is an example of how the method is called:

```
double result;
result = Math.Sqrt(4.0, 2.0);
```

The method takes two `double` arguments. It raises the first argument to the power of the second argument and returns the result as a `double`. In this example, 4.0 is raised to the power of 2.0. This statement is equivalent to the following algebraic statement:

$$result = 4^2$$

The following code sample shows another example of a statement using the `Math.Pow` method. It assigns 3 times  $6^3$  to `x`:

```
double x;
x = 3 * Math.Pow(6.0, 3.0);
```

The `Math.Sqrt` method accepts an argument and returns the square root of the argument. Here is an example of how it is used:

```
double result;
result = Math.Sqrt(16.0);
```

The statement that calls the `Math.Sqrt` method passes 16.0 as an argument. The method returns the square root of 16.0 (as a `double`), which is then assigned to the `result` variable.

## The `Math.PI` and `Math.E` Named Constants

The `Math` class also provides two predefined named constants, `Math.PI` and `Math.E`, which are assigned mathematical values for  $\pi$  and  $e$ . You can use these variables in equations that require their values. For example, the following statement, which calculates the area of a circle, uses `Math.PI`.

```
area = Math.PI * radius * radius;
```



**NOTE:** If you look at the top of a form's source code in the code editor, you should see a directive that reads `using System;`. That directive is required for any program that uses the `Math` class.



### Checkpoint

- 3.47 Write a programming statement that uses the `Math.Pow` method to square the number 12 and store the result in a `double` variable named `product`.
- 3.48 What method of the `Math` class can be used to determine the larger of two values?
- 3.49 What method of the `Math` class can be used to determine the smaller of two values?

## 3.11

## More GUI Details

In Chapter 2 you learned the basics of creating a GUI by placing controls on a form and setting various properties. In this section you learn to fine-tune many aspects of an application's GUI.

### Controlling a Form's Tab Order

When an application is running and a form is displayed, one of the form's controls always has the focus. The control having the **focus** is the one that receives the user's keyboard input. For example, when a `TextBox` control has the focus, it receives the characters that the user enters on the keyboard. When a button has the focus, pressing the `Enter` key executes the button's `Click` event handler.



**NOTE:** Only controls capable of receiving some sort of input, such as text boxes and buttons, may have the focus.

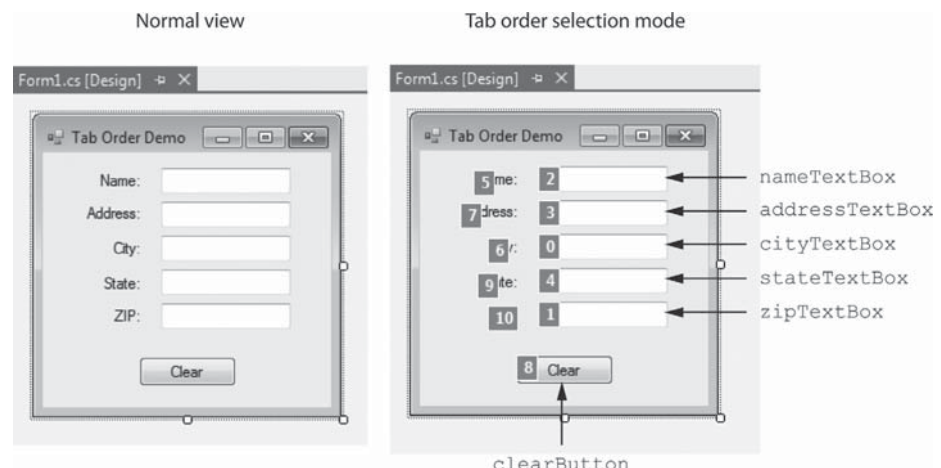
You can tell which control has the focus by looking at the form at run time. When a `TextBox` control has the focus, a blinking text cursor appears inside it, or the text inside the `TextBox` control might appear highlighted. When a button has the focus, a thin dotted line usually appears around the control.

When an application is running, pressing the `Tab` key changes the focus from one control to another. The order in which controls receive the focus is called the **tab order**. When you place controls on a form in Visual C#, the tab order is in the same sequence in which you created the controls. In many cases this is the tab order you want, but sometimes you rearrange controls on a form, delete controls, and add new ones. These modifications often lead to a disorganized tab order, which can confuse and irritate the users of your application.

Users want to tab smoothly from one control to the next, in a logical sequence. You can modify the tab order by changing a control's `TabIndex` property. The **`TabIndex` property** contains a numeric value, which indicates the control's position in the tab order. When you create a control, Visual C# automatically assigns a value to its `TabIndex` property. The first control you create on a form has a `TabIndex` of 0, the second has a `TabIndex` of 1, and so on. The control with a `TabIndex` of 0 is the first control in the tab order. The next control in the tab order is the one with a `TabIndex` of 1. The tab order continues in this sequence.

You may change the tab order of a form's controls by selecting them, one by one, and changing their `TabIndex` property in the *Properties* window. An easier method, however, is to click *VIEW* on the Visual Studio menu bar and then click *Tab Order*. This causes the form to be displayed in **tab order selection mode**. The image on the left in Figure 3-31 shows a form in the normal view, and the image on the right shows the form in tab order selection mode. We have also inserted the names of the `TextBox` and `Button` controls in the image on the right for reference purposes.

**Figure 3-31** A form displayed in tab order selection mode



In tab order selection mode, each control's existing `TabIndex` value is displayed in a small box in the control's upper-left corner. Notice the following in the image on the right in Figure 3-31:

- The `nameTextBox` control's `TabIndex` is 2.
- The `addressTextBox` control's `TabIndex` is 3.
- The `cityTextBox` control's `TabIndex` is 0.
- The `stateTextBox` control's `TabIndex` is 4.
- The `zipTextBox` control's `TabIndex` is 1.
- The `clearButton` control's `TabIndex` is 8.



**NOTE:** Although the Label controls have `TabIndex` values, those values are irrelevant in this example because Label controls cannot receive the focus.

As you look at Figure 3-31, think about the order in which the controls will receive the focus when the application runs.

- The `cityTextBox` control has the lowest `TabIndex` value (0), so it will receive the focus first.
- If you press the Tab key, the focus will jump to the `zipTextBox` control because it has the next lowest `TabIndex` value (1).
- Press the Tab key again and the focus will jump to the `nameTextBox` control (`TabIndex` is set to 2).
- Press the Tab key again and the focus will jump to the `addressTextBox` control (`TabIndex` is set to 3).
- Press the Tab key again and the focus will jump to the `stateTextBox` control (`TabIndex` is set to 4).
- Press the Tab key again and the focus will jump to the `clearButton` control (`TabIndex` is set to 8).

This is a very confusing tab order and should be rearranged. When a form is displayed in tab order selection mode, you establish a new tab order by simply clicking the controls with the mouse in the order you want. To fix the disorganized tab order shown in Figure 3-31, we perform the following:

- First, click the `nameTextBox` control. The control's `TabIndex` value changes to 0.
- Next, click the `addressTextBox` control. The control's `TabIndex` value changes to 1.
- Then, click the `cityTextBox` control. The control's `TabIndex` value changes to 2.
- Next, click the `stateTextBox` control. The control's `TabIndex` value changes to 3.
- Then, click the `zipTextBox` control. The control's `TabIndex` value changes to 4.
- Finally, click the `clearButton` control. The control's `TabIndex` value changes to 5.

When you are finished, exit tab order selection mode by pressing the Esc key. Now when the application runs, the focus will shift smoothly in an order that makes sense to the user.

## Changing the Focus with the `Focus` Method

Often, you want to make sure a particular control has the focus. For example, look at the form shown in Figure 3-31. The purpose of the *Clear* button is to clear any input that the user has entered and reset the form so it is ready to accept a new set of input. When the *Clear* button is clicked, the `TextBox` controls should be cleared and the focus should return to the `nameTextBox` control. This would make it unnecessary for the user to click the `TextBox` control in order to start entering another set of information.

In code, you move the focus to a control by calling the **Focus** method. The method's general syntax is:

```
ControlName.Focus();
```

where *ControlName* is the name of the control. For instance, you move the focus to the `nameTextBox` control with this statement:

```
nameTextBox.Focus();
```

After the statement executes, the `nameTextBox` control will have the focus. Here is an example of how the `clearButton` control's Click event handler could be written:

```
1 private void clearButton_Click(object sender, EventArgs e)
2 {
3     // Clear the TextBox controls.
4     nameTextBox.Text = "";
5     addressTextBox.Text = "";
6     cityTextBox.Text = "";
7     stateTextBox.Text = "";
8     zipTextBox.Text = "";
9
10    // Set the focus to nameTextBox.
11    nameTextBox.Focus();
12 }
```

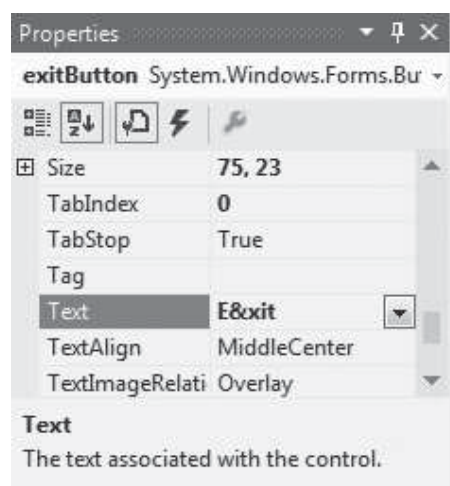
The statements in lines 4–8 clear the contents of the `TextBox` controls. Then, the statement in line 11 sets the focus to the `nameTextBox` control.

## Assigning Keyboard Access Keys to Buttons

An **access key**, also known as a **mnemonic**, is a key that is pressed in combination with the Alt key to access quickly a control such as a button. When you assign an access key to a button, the user can trigger a Click event either by clicking the button with the mouse or by using the access key. Users who are quick with the keyboard prefer to use access keys instead of the mouse.

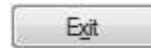
You assign an access key to a button through its `Text` property. For example, assume an application has a button whose `Text` property is set to *Exit*. You wish to assign the access key **Alt** + **X** to the button so the user may trigger the button's Click event by pressing **Alt** + **X** on the keyboard. To make the assignment, place an ampersand (&) before the letter *x* in the button's `Text` property: **E&xit**. Figure 3-32 shows how the `Text` property appears in the *Properties* window.

**Figure 3-32** Text property **E&xit**



Although the ampersand is part of the Button control's Text property, it is not displayed on the button. With the ampersand in front of the letter *x*, the letter will appear underlined as shown in Figure 3-33. This indicates that the button may be clicked by pressing **Alt** + **X** on the keyboard. (You will see the underlining at design time. At run time, however, the underlining may not appear until the user presses the Alt key.)

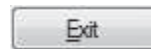
**Figure 3-33** Button control with `&Exit` Text property



**NOTE:** Access keys do not distinguish between uppercase and lowercase characters. There is no difference between **Alt** + **X** and **Alt** + **x**.

Suppose we store the value `&Exit` in the button's Text property. The ampersand is in front of the letter *E*, so **Alt** + **E** becomes the access key. The button will appear as shown in Figure 3-34.

**Figure 3-34** Button control with `&Exit` Text property



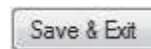
### Assigning the Same Access Key to Multiple Buttons

Be careful not to assign the same access key to two or more buttons on the same form. If two or more buttons share the same access key, a Click event is triggered for the first button created when the user presses the access key.


### Displaying the & Character on a Button

If you want to display an ampersand character on a button, use two ampersands (`&&`) in the Text property. Using two ampersands causes a single ampersand to display and does not define an access key. For example, if a button's Text property is set to `Save && Exit`, the button will appear as shown in Figure 3-35.

**Figure 3-35** Button control with `Save && Exit` Text property



## Accept Buttons and Cancel Buttons

An **accept button** is a button on a form that is automatically clicked when the user presses the Enter key. A **cancel button** is a button on a form that is automatically clicked when the user presses the Esc key. Forms have two properties, `AcceptButton` and `CancelButton`, which allow you to designate an accept button and a cancel button. When you select these properties in the *Properties* window, a down-arrow button () appears, which displays a drop-down list when clicked. The list contains the names of all the buttons on the form. You select the button that you want to designate as the accept button or cancel button.

Any button that is frequently clicked should probably be selected as the accept button. This will allow keyboard users to access the button quickly and easily. *Exit* or *Cancel* buttons are likely candidates to become cancel buttons.

## The BackColor Property

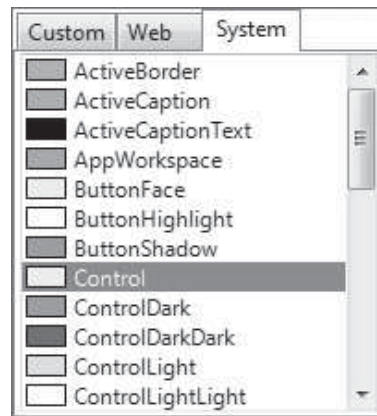
Forms and most controls have a **BackColor** property that allows you to change the object's background color. When you select an object's BackColor property in the *Properties* window, a down-arrow button (▾) appears, which displays a drop-down list of available colors when clicked, as shown in Figure 3-36.

The drop-down list has three tabs: *Custom*, *Web*, and *System*. The *System* tab lists colors defined in the current Windows configuration. The *Web* tab lists colors displayed with consistency in Web browsers. The *Custom* tab displays a color palette. Select a color from one of the tabs and the object's background color will be set to that color.

## The ForeColor Property

Controls that display text have a **ForeColor** property that allows you to change the color of the text. When you select a control's ForeColor property in the *Properties* window, a down-arrow button (▾) appears, which displays the drop-down list of available colors shown in Figure 3-36 when clicked. Select a color from one of the tabs and the text that is displayed by the control will be set to that color.

**Figure 3-36** Drop-down list of colors



## Setting Colors in Code

In addition to using the *Properties* window, you can also set the values of the BackColor and ForeColor properties with code. The .NET Framework provides numerous values that represent colors and can be assigned to the ForeColor and BackColor properties in code. The following are a few of the values:

```
Color.Black
Color.Blue
Color.Cyan
Color.Green
Color.Magenta
Color.Red
Color.White
Color.Yellow
```

For example, assume an application has a Label control named `messageLabel`. The following code sets the label's background color to black and foreground color to yellow:

```
messageLabel.BackColor = Color.Black;
messageLabel.ForeColor = Color.Yellow;
```

The .NET Framework also provides values that represent default colors on your system. For example, the value `SystemColors.Control` represents the default control background color and `SystemColors.ControlText` represents the default control text color. The following statements set the `messageLabel` control's background and foreground to the default colors.

```
messageLabel.BackColor = SystemColors.Control
messageLabel.ForeColor = SystemColors.ControlText
```




**NOTE:** If you have an event handler in a form's source code file and you want the event handler to change the form's `BackColor` property, use the `this` keyword to refer to the form. For example, the following statement changes the color of the form to blue:

```
this.BackColor = Color.Blue;
```

## Background Images for Forms

In Chapter 2 you learned about displaying images with `PictureBox` controls. An image can also be displayed as the background for a form. Forms have a property named `BackgroundImage` that allows you to import and display an image on the form. If you know how to use the `PictureBox` control's `Image` property, then you already know how to use a form's `BackgroundImage` property. They both work the same way:

- Click the `BackgroundImage` property in the *Properties* window. An ellipses button () will appear.
- Click the ellipses button and the *Select Resource* window will appear.
- In the *Select Resource* window, click the *Import* button. An *Open* dialog box will appear. Use the dialog box to locate and select the image file that you want to display.
- Click the *OK* button in the *Select Resource* window, and the selected image will appear as the form's background.

A form's `BackgroundImageLayout` property is similar to the `PictureBox` control's `SizeMode` property. It specifies how the background image is to be displayed. It can be set to one of the following values:

- **None**  
The image is positioned in the upper-left corner of the form. If the image is too big to fit in the form, it is clipped.
- **Tile**  
This is the default value. The image is tiled (repeatedly displayed) across the form.
- **Center**  
The image is centered in the form without being resized.
- **Stretch**  
The image is resized both horizontally and vertically to fit in the form. If the image is resized more in one direction than the other, it appears stretched.
- **Zoom**  
The image is uniformly resized to fit in the form without losing its original aspect ratio. This causes the image to be resized without appearing stretched.

Figure 3-37 shows examples of each of these settings.



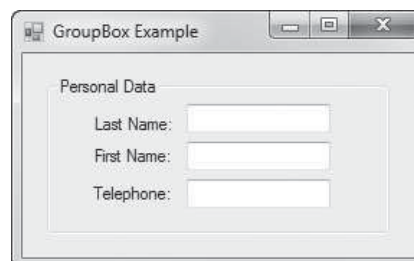
**Figure 3-37** Different settings for the BackgroundImageLayout property

## Organizing Controls with GroupBoxes and Panels

A **GroupBox** control is a rectangular control that appears with a thin border and an optional title in its upper-left corner. It is a container that can hold other controls. You can use GroupBoxes to create a sense of visual organization on a form.

The GroupBox control is found in the *Toolbox*, in the *Containers* section. When you create a GroupBox control, you can set its Title property to the text that you want displayed in the GroupBox's upper-left corner. If you don't want a title displayed on the GroupBox, you can clear the contents of its Text property.

Figure 3-38 shows a GroupBox control. The control's Text property is set to *Personal Data*, and several other controls are inside the GroupBox.

**Figure 3-38** A GroupBox containing other controls

### Creating a Group Box and Adding Controls to It

Suppose you've just created a `GroupBox` control. To add another control to the `GroupBox`, select the `GroupBox` control and then double-click the desired tool in the *Toolbox* to place another control inside the group box.

### Moving an Existing Control to a Group Box

If an existing control is not inside a `GroupBox` but you want to move it to the `GroupBox`, follow these steps:

1. Select the control you wish to add to the `GroupBox`.
2. Cut the control to the clipboard.
3. Select the `GroupBox`.
4. Paste the control.

### Moving and Resizing a GroupBox

If a `GroupBox` is selected in the *Designer*, a four-headed arrow (⛶) will appear in the `GroupBox`'s upper-left corner. Click and drag the four-headed arrow to move the `GroupBox`. Any controls inside the `GroupBox` move with it.

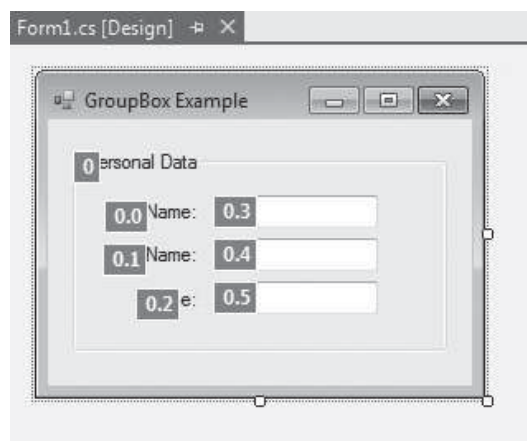
### Deleting a GroupBox

To delete a `GroupBox`, simply select it in the *Designer* and then press the `Delete` key. Any controls inside the `GroupBox` are deleted as well.

### Group Box Tab Order

The value of a control's `TabIndex` property is handled differently when the control is placed inside a `GroupBox` control. `GroupBox` controls have their own `TabIndex` property, and the `TabIndex` value of the controls inside the group box are relative to the `GroupBox` control's `TabIndex` property. For example, Figure 3-39 shows a `GroupBox` control displayed in tab order selection mode. As you can see, the `GroupBox` control's `TabIndex` is set to 0. The `TabIndex` of the controls inside the group box is displayed as 0.0, 0.1, 0.2, and so on.

**Figure 3-39** `GroupBox` `TabIndex` values



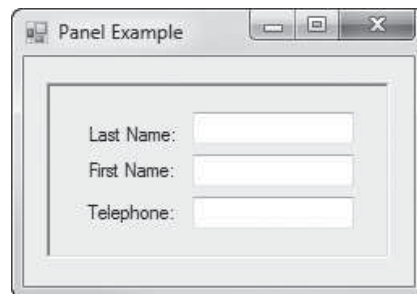
**NOTE:** The `TabIndex` properties of the controls inside the group box will not appear this way in the *Properties* window. They will appear as 0, 1, 2, and so on.

A **Panel control** is a rectangular container for other controls, like a **GroupBox**. There are several primary differences between a **Panel** and **GroupBox**:

- A **Panel** cannot display a title and does not have a **Text** property.
- A **Panel**'s border can be specified by its **BorderStyle** property. The available settings are **None**, **FixedSingle**, and **Fixed3D**. The property is set to **None** by default, which means that no border will appear. If the **BorderStyle** property is set to **FixedSingle**, the control will be outlined with a thin border. If the **BorderStyle** property is set to **Fixed3D**, the control will have a recessed 3D appearance.

Figure 3-40 shows an example of a form with a **Panel**. The **Panel**'s **BorderStyle** property is set to **Fixed3D**.

**Figure 3-40** A **Panel** containing other controls



## Checkpoint

- 3.50 What happens if you press the Enter key while a **Button** control has the focus?
- 3.51 How do you display a form in tab order selection mode? How do you exit tab order selection mode?
- 3.52 Write a programming statement that gives the focus to a **TextBox** control named `numberTextBox`.
- 3.53 How do you assign an access key to a **Button** control?
- 3.54 How do you display an ampersand (&) character on a **Button** control?
- 3.55 Write the code that will change the **BackColor** property of a **Label** control named `resultLabel` to the color white and the **ForeColor** property to the color red.
- 3.56 List the different values of a form's **BackgroundImageLayout** property.
- 3.57 When a **GroupBox** control is deleted, what happens to the controls that are inside?
- 3.58 How are the **TabIndex** properties of the controls inside the group box organized?
- 3.59 How is a **Panel** control different from a **GroupBox** control?

## Key Terms

accept button  
 access key  
 access modifier  
 argument  
 BackColor property  
 break mode  
 cancel button  
 cast operator  
 catch block  
 catch clause  
 combined assignment operators  
 concatenation  
 constant field  
 data type  
 decimal literal  
 decimal.Parse method  
 double literal  
 double.Parse method  
 exception  
 exception handler  
 exception object  
 field  
 focus  
 Focus method  
 ForeColor  
 formatting string  
 GroupBox Control  
 initialize  
 int.Parse method  
 integer literal  
 lifetime  
 local variable  
 math expression  
 math operators  
 mnemonic  
 named constant  
 numeric literal  
 operands  
 order of operations  
 Panel control  
 parse  
 Parse methods  
 primitive data types  
 scope  
 tab order  
 tab order selection mode  
 TabIndex property  
 TextBox control  
 ToString method  
 truncation  
 try block  
 try-catch statement  
 variable  
 variable declaration  
 variable name

## Review Questions

- When the user types into a TextBox control, the text is stored in the control's \_\_\_\_\_ property.
  - Input
  - Text
  - String
  - Data
- A \_\_\_\_\_ is a storage location in memory that is represented by a name.
  - mnemonic
  - data type
  - namespace
  - variable
- In C#, you must \_\_\_\_\_ a variable before you can use it to store data.
  - cite
  - associate
  - declare
  - instance

4. A variable's \_\_\_\_\_ indicates the type of data that the variable will hold.
  - a. name
  - b. data type
  - c. scope
  - d. value
5. Fundamental types of data, such as strings, integers, and real numbers, are known as \_\_\_\_\_.
  - a. primitive data types
  - b. fundamental variables
  - c. logical digits
  - d. literal data types
6. A \_\_\_\_\_ identifies a variable in the program code.
  - a. binary number
  - b. variable name
  - c. unique global identifier
  - d. hexadecimal value
7. A common operation performed on strings is \_\_\_\_\_, or appending one string to the end of another string.
  - a. addition
  - b. merging
  - c. concatenation
  - d. tying
8. A \_\_\_\_\_ belongs to the method in which it is declared, and only statements inside that method can access the variable.
  - a. method variable
  - b. primitive variable
  - c. temporary variable
  - d. local variable
9. Programmers use the term \_\_\_\_\_ to describe the part of a program in which a variable may be accessed.
  - a. range
  - b. scope
  - c. focus
  - d. field
10. A variable's \_\_\_\_\_ is the time period during which the variable exists in memory while the program is executing.
  - a. lifetime
  - b. run time
  - c. time to live
  - d. half life
11. One way to make sure that a variable has been assigned a value is to \_\_\_\_\_ the variable with a value when you declare it.
  - a. concatenate
  - b. initialize
  - c. delimit
  - d. restrict

12. You can use a \_\_\_\_\_ to explicitly convert a value from one numeric data type to another, even if the conversion might result in a loss of data.
  - a. transpose statement
  - b. cast operator
  - c. conversion operator
  - d. literal conversion
13. The process of dropping a number's fractional part is called \_\_\_\_\_.
  - a. shifting
  - b. twos complement
  - c. numeric rounding
  - d. truncation
14. A programmer's tools for performing calculations are \_\_\_\_\_.
  - a. math operators
  - b. numeric literals
  - c. local variables
  - d. parsed literals
15. A \_\_\_\_\_ performs a calculation and gives a value.
  - a. numeric literal
  - b. math expression
  - c. machine instruction
  - d. programming statement
16. C# offers a special set of operators known as \_\_\_\_\_ that are designed specifically for changing the value of a variable without having to type the variable name twice.
  - a. combined assignment operators
  - b. advanced math operators
  - c. variable modifiers
  - d. assignment sequencers
17. In computer science, the term \_\_\_\_\_ typically means to analyze a string of characters for some purpose.
  - a. compile
  - b. compute
  - c. debug
  - d. parse
18. A(n) \_\_\_\_\_ is a piece of data that is passed into a method.
  - a. variable
  - b. argument
  - c. string
  - d. literal
19. A(n) \_\_\_\_\_ is an unexpected error that occurs while a program is running, causing the program to halt if the error is not properly dealt with.
  - a. breakpoint
  - b. bug
  - c. syntax error
  - d. exception

20. The \_\_\_\_\_ indicates that you want the number to appear formatted in a specific way when it is returned as a string from the `ToString` method.
  - a. formatting string
  - b. `insert` method
  - c. data type
  - d. variable name
21. You have started an application by clicking the start *Debugging* button (🐞) or by pressing `F5` on the keyboard. If an exception is thrown, the application stops running and Visual Studio goes into a special mode known as \_\_\_\_\_.
  - a. exception mode
  - b. break mode
  - c. debug mode
  - d. crash mode
22. Code that responds to exceptions when they are thrown and prevents the program from abruptly crashing is called a(n) \_\_\_\_\_.
  - a. exit strategy
  - b. fail safe
  - c. event handler
  - d. exception handler
23. A \_\_\_\_\_ is a name that represents a value that cannot be changed during the program's execution.
  - a. named literal
  - b. named constant
  - c. variable signature
  - d. key term
24. A \_\_\_\_\_ is a variable that is declared inside a class but not inside any method.
  - a. term
  - b. class variable
  - c. field
  - d. mnemonic
25. A(n) \_\_\_\_\_ specifies how a class member can be accessed by code outside the class.
  - a. namespace
  - b. access modifier
  - c. scope delimiter
  - d. class directive
26. A \_\_\_\_\_ is a field that cannot be changed by any statement in the class.
  - a. static field
  - b. class name
  - c. key field
  - d. constant field
27. The .NET Framework provides a class named \_\_\_\_\_, which contains numerous methods that are useful for performing advanced mathematical operations.
  - a. `Math`
  - b. `Calc`
  - c. `Trig`
  - d. `Linq`

28. When a control has the \_\_\_\_\_, it receives the user's keyboard input.
  - a. text
  - b. tab order
  - c. focus
  - d. input allocator
29. The order in which controls receive the focus is called the \_\_\_\_\_.
  - a. order of operations
  - b. program flow
  - c. execution sequence
  - d. tab order
30. The \_\_\_\_\_ contains a numeric value, which indicates the control's position in the tab order.
  - a. `IndexOf` property
  - b. `TabIndex` property
  - c. `ControlOrder` property
  - d. `TabOrder` property

### True or False

1. You can clear the contents of a `TextBox` control in the same way that you clear the contents of a `Label` control.
2. In C#, you must declare a variable in a program before you can use it to store data.
3. You can declare multiple variables of different data types with one declaration.
4. When you append the letter `D` or `d` to a numeric literal, it is treated as a `decimal` and is referred to as a `decimal` literal.
5. The order of operations dictates that the division operator works before the addition operator does.
6. All variables have a `ToString` method that you can call to convert the variable's value to a string.
7. When you pass the formatting string `"C"` or `"c"` to the `ToString` method, the number is returned formatted as currency.
8. When you declare a named constant, an initialization value is required.
9. An error will occur if the compiler finds a statement that tries to change the value of a constant field.
10. Forms and most controls have a `Preferences` property that allows you to change the object's background color.

### Short Answer

1. In the *Toolbox*, in which group is the `TextBox` tool located?
2. What two things does a variable declaration specify about a variable?
3. Give an example of a programming statement that uses string concatenation.
4. What is the term used for a number that is written into a program's code?
5. Write a programming statement that assigns an integer literal to a variable.
6. What are the values on the right and left of an operator called?
7. Name the family of methods in the .NET Framework that can be used to convert a string to any of the numeric data types.



8. What object is created in memory when an exception is thrown and has various properties that contain data about the exception?
9. What is the purpose of a `try-catch` statement?
10. Which class in the .NET Framework provides predefined named constants that are assigned the mathematical values for  $\pi$  and  $e$ ?
11. In code, what function do you call to move the focus to a control?
12. What property allows you to change the color of a control's text?

## Programming Problems

### 1. Name Formatter

Create an application that lets the user enter the following pieces of data:

- The user's first name
- The user's middle name
- The user's last name
- The user's preferred title (Mr., Mrs., Ms., Dr., etc.)

Assume the user has entered the following data:

- First name: *Kelly*
- Middle name: *Jane*
- Last name: *Smith*
- Title: *Ms.*

The application should have buttons that display the user's name formatted in the following ways:

*Ms. Kelly Jane Smith*  
*Kelly Jane Smith*  
*Kelly Smith*  
*Smith, Kelly Jane, Ms.*  
*Smith, Kelly Jane*  
*Smith, Kelly*

### 2. Tip, Tax, and Total

Create an application that lets the user enter the food charge for a meal at a restaurant. When a button is clicked, the application should calculate and display the amount of a 15 percent tip, 7 percent sales tax, and the total of all three amounts.

### 3. Distance Traveled

Assuming there are no accidents or delays, the distance that a car travels down an interstate highway can be calculated with the following formula:

$$\text{Distance} = \text{Speed} \times \text{Time}$$

Create an application that allows the user to enter a car's speed in miles per hour.

The application should have buttons that display the following:

- The distance the car will travel in 5 hours
- The distance the car will travel in 8 hours
- The distance the car will travel in 12 hours

### 4. Sales Tax and Total

Create an application that allows the user to enter the amount of a purchase. The program should then calculate the state and county sales tax. Assume the state sales tax is 4 percent and the county sales tax is 2 percent. The program should display



VideoNote

Solving the  
Tip, Tax,  
and Total  
Problem

the amount of the purchase, the state sales tax, the county sales tax, the total sales tax, and the total of the sale (which is the sum of the amount of purchase plus the total sales tax).

### 5. Celsius and Fahrenheit Temperature Converter

Assuming that  $C$  is a Celsius temperature, the following formula converts the temperature to Fahrenheit:

$$F = \frac{9}{5} C + 32$$

Assuming that  $F$  is a Fahrenheit temperature, the following formula converts the temperature to Celsius:

$$C = \frac{5}{9} (F - 32)$$

Create an application that allows the user to enter a temperature. The application should have Button controls described as follows:

- A button that reads *Convert to Fahrenheit*. If the user clicks this button, the application should treat the temperature that is entered as a Celsius temperature and convert it to Fahrenheit.
- A button that reads *Convert to Celsius*. If the user clicks this button, the application should treat the temperature that is entered as a Fahrenheit temperature, and convert it to Celsius.

### 6. Body Mass Index

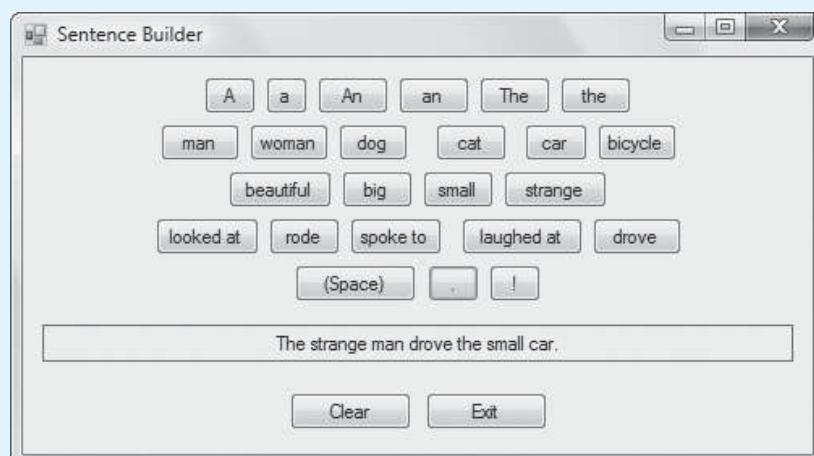
Create an application that lets the user enter his or her weight (in pounds) and height (in inches). The application should display the user's body mass index (BMI). The BMI is often used to determine whether a person is overweight or underweight for his or her height. A person's BMI is calculated with the following formula:

$$BMI = weight \times 703 \div height^2$$

### 7. Sentence Builder

The form in Figure 3-41 contains buttons showing various words, phrases, and punctuation. Create an application with a form similar to this one. When the application runs, the user clicks the buttons to build a sentence, which is shown in a Label control. You can use the same buttons as shown in the figure or make up your own. The *Reset* button should clear the sentence so the user can start over.

**Figure 3-41** The *Sentence Builder* form



**8. How Much Insurance?**

Many financial experts advise that property owners should insure their homes or buildings for at least 80 percent of the amount it would cost to replace the structure. Create an application that lets the user enter the replacement cost of a building and then displays the minimum amount of insurance he or she should buy for the property.

**9. Cookie Calories**

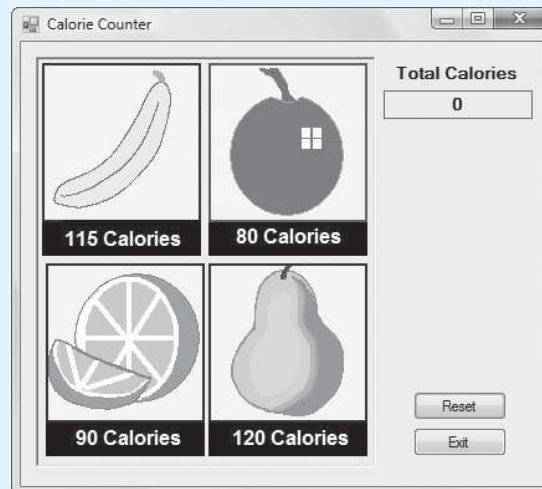
A bag of cookies holds 40 cookies. The calorie information on the bag claims that there are 10 servings in the bag and that a serving equals 300 calories. Create an application that lets the user enter the number of cookies he or she actually ate and then reports the number of total calories consumed.

**10. Calorie Counter**

Create an application with a form that resembles Figure 3-42. The PictureBox controls display the images of four fruits (a banana, an apple, an orange, and a pear) and each fruit's calories. You can find these images in the *Chap03* folder of the Student Sample Programs.

When the application starts, the total calories displayed should be zero. Each time the user clicks one of the PictureBoxes, the calories for that fruit should be added to the total calories, and the total calories should be displayed. When the user clicks the *Reset* button, the total calories should be reset to zero.

**Figure 3-42** Calorie Counter form

**11. Automobile Costs**

Create an application that lets the user enter the monthly costs for the following expenses incurred from operating his or her automobile: loan payment, insurance, gas, oil, tires, and maintenance. The program should then display the total monthly cost of these expenses and the total annual cost of these expenses.

**12. Paint Job Estimator**

A painting company has determined that for every 115 square feet of wall space, 1 gallon of paint and 8 hours of labor will be required. The company charges \$20.00 per hour for labor. Create an application that allows the user to enter the square feet of wall space to be painted and the price of the paint per gallon. The program should display the following data:

- The number of gallons of paint required
- The hours of labor required

- The cost of the paint
- The labor charges
- The total cost of the paint job

13. Property Tax

If you own real estate in a particular county, the property tax that you owe each year is calculated as 64 cents per \$100 of the property’s value. For example, if the property’s value is \$10,000, then the property tax is calculated as follows:

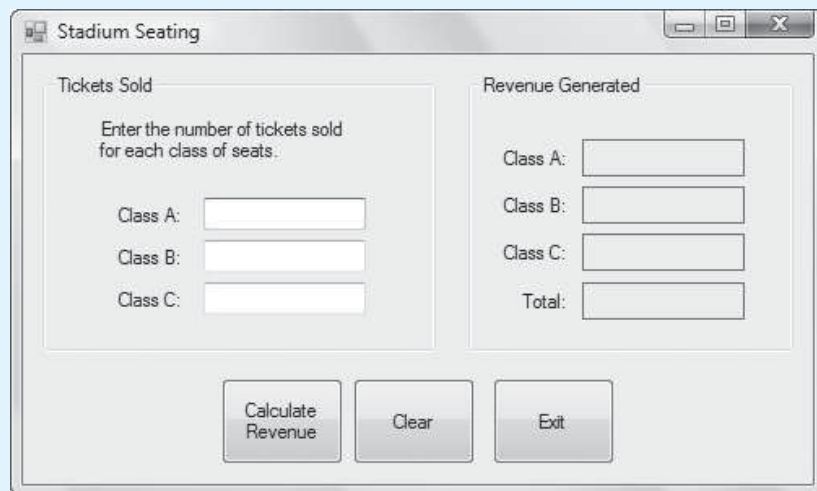
$$\text{Tax} = \$10,000 \div 100 \times 0.64$$

Create an application that allows the user to enter a property’s value and displays the sales tax on that property.

14. Stadium Seating

There are three seating categories at an athletic stadium. For a baseball game, Class A seats cost \$15 each, Class B seats cost \$12 each, and Class C seats cost \$9 each. Create an application that allows the user to enter the number of tickets sold for each class. The application should be able to display the amount of income generated from each class of ticket sales and the total revenue generated. The application’s form should resemble the one shown in Figure 3-43.

Figure 3-43 Stadium Seating form



Use the following sets of test data to determine if the application is calculating properly:

Ticket Sales	Revenue
Class A: 320	Class A: \$4,800.00
Class B: 570	Class B: \$6,840.00
Class C: 890	Class C: \$8,010.00
	<i>Total Revenue: \$19,650.00</i>
Class A: 500	Class A: \$7,500.00
Class B: 750	Class B: \$9,000.00
Class C: 1,200	Class C: \$10,800.00
	<i>Total Revenue: \$27,300.00</i>
Class A: 100	Class A: \$1,500.00
Class B: 300	Class B: \$3,600.00
Class C: 500	Class C: \$4,500.00
	<i>Total Revenue: \$9,600.00</i>

*This page intentionally left blank*

## TOPICS

- |   |  |
|---|--|
| 4.1 Decision Structures and the <code>if</code> Statement | 4.7 Preventing Data Conversion Exceptions with the <code>TryParse</code> Methods |
| 4.2 The <code>if-else</code> Statement                    | 4.8 Input Validation   |
| 4.3 Nested Decision Structures                            | 4.9 Radio Buttons and Check Boxes  |
| 4.4 Logical Operators                                     | 4.10 The <code>switch</code> Statement   |
| 4.5 <code>bool</code> Variables and Flags                 | 4.11 Introduction to List Boxes  |
| 4.6 Comparing Strings                                     |  |

## 4.1

Decision Structures and the `if` Statement

**CONCEPT:** A decision structure allows a program to perform actions only under certain conditions. In code, you can use the `if` statement to write a simple decision structure.

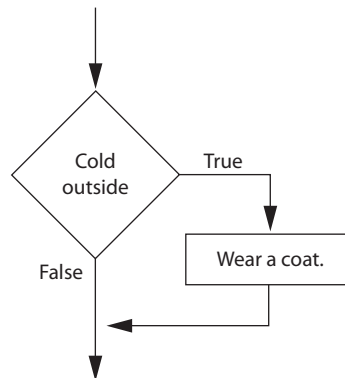
A **control structure** is a logical design that controls the order in which a set of statements execute. So far in this book we have used only the simplest type of control structure: the sequence structure. A **sequence structure** is a set of statements that execute in the order that they appear. For example, the following code sample is a sequence structure because the statements execute from top to bottom.

```
int ageInYears, ageInDays;  
ageInYears = int.Parse(ageTextBox.Text);  
ageInDays = ageInYears * 365;  
daysLabel = ageInDays.ToString();
```

Although the sequence structure is heavily used in programming, it cannot handle every type of task. Some problems simply cannot be solved by performing a set of ordered steps, one after the other. For example, consider a pay-calculating program that determines whether an employee has worked overtime. If the employee has worked more than 40 hours, he or she gets paid extra for all hours over 40. Otherwise, the overtime calculation should be skipped. Programs like this require a different type of control structure: one that can execute a set of statements only under certain circumstances. This can be accomplished with a **decision structure**. (Decision structures are also known as **selection structures**.)

In a decision structure's simplest form, a specific action is performed only if a certain condition exists. If the condition does not exist, the action is not performed. The flowchart shown in Figure 4-1 shows how the logic of an everyday decision can be diagrammed as a decision structure. The diamond symbol represents a true-false condition. If the condition is true, we follow one path, which leads to an action being performed. If the condition is false, we follow another path, which skips the action.

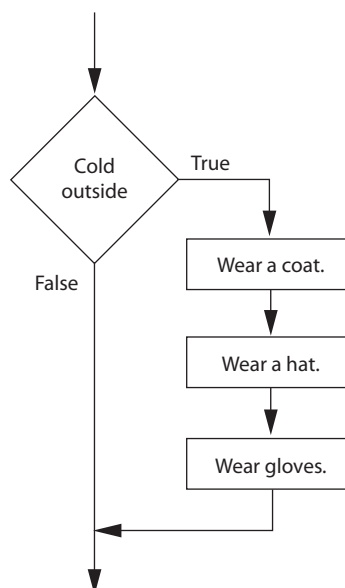
**Figure 4-1** A simple decision structure



In the flowchart, the diamond symbol indicates some condition that must be tested. In this case, we are determining whether the condition *Cold outside* is true or false. If this condition is true, the action *Wear a coat* is performed. If the condition is false, the action is skipped. The action is **conditionally executed** because it is performed only when a certain condition is true.

Programmers call the type of decision structure shown in Figure 4-1 a **single-alternative decision structure** because it provides only one alternative path of execution. If the condition in the diamond symbol is true, we take the alternative path. Otherwise, we exit the structure. Figure 4-2 shows a more elaborate example, where three actions are taken only when it is cold outside.

**Figure 4-2** A decision structure that performs three actions if it is cold outside



In C#, you use the `if` statement to write a single-alternative decision structure. Here is the general format of the `if` statement:

```
if (expression)
{
    statement;
    statement;
    etc.
}
```

The statement begins with the word `if`, followed by an *expression* enclosed in a set of parentheses. Beginning on the next line is a set of statements enclosed in curly braces.

The *expression* that appears inside the parentheses is a Boolean expression. A **Boolean expression** is an expression that can be evaluated as either true or false. When the `if` statement executes, the Boolean expression is tested. If it is true, the statements that appear inside the curly braces are executed. If the Boolean expression is false, however, the statements inside the curly braces are skipped. We say that the statements inside the curly braces are *conditionally executed* because they are executed only if the Boolean expression is true.

If you are writing an `if` statement that has only one conditionally executed statement, you do not have to enclose the conditionally executed statement inside curly braces. Such an `if` statement can be written in the following general format:

```
if (expression)
    statement;
```

When an `if` statement written in this format executes, the Boolean expression is tested. If it is true, the one statement that appears on the next line is executed. If the Boolean expression is false, however, that one statement is skipped.

Although the curly braces are not required when there is only one conditionally executed statement, it is still a good idea to use them, as shown in the following general format:

```
if (expression)
{
    statement;
}
```

This is a good style for writing `if` statements because it minimizes errors. Remember, if you have more than one conditionally executed statement, those statements *must* be enclosed in curly braces. If you get into the habit of always enclosing the conditionally executed statements in a set of curly braces, it's less likely that you will forget them.

## Boolean Expressions and Relational Operators

Boolean expressions are named in honor of the English mathematician George Boole. In the 1800s, Boole invented a system of mathematics in which the abstract concepts of true and false can be used in computations.

Typically, the Boolean expression that is tested by an `if` statement is formed with a relational operator. A **relational operator** determines whether a specific relationship exists between two values. For example, the greater than operator (`>`) determines whether one value is greater than another. The equal to operator (`==`) determines whether two values are equal. Table 4-1 lists the relational operators that are available in C#.

The following is an example of an expression that uses the greater than (`>`) operator to compare two variables, `length` and `width`:

```
length > width
```



**Table 4-1** Relational operators

Operator	Meaning
>	Greater than
<	Less than
>=	Greater than or equal to
<=	Less than or equal to
==	Equal to
!=	Not equal to

This expression determines whether the value of the `length` variable is greater than the value of the `width` variable. If `length` is greater than `width`, the value of the expression is true. Otherwise, the value of the expression is false. The following expression uses the less than operator (`<`) to determine whether `length` is less than `width`:

```
length < width
```

Table 4-2 shows examples of several Boolean expressions that compare the variables `x` and `y`.

**Table 4-2** Boolean expressions using relational operators

Expression	Meaning
<code>x &gt; y</code>	Is <code>x</code> greater than <code>y</code> ?
<code>x &lt; y</code>	Is <code>x</code> less than <code>y</code> ?
<code>x &gt;= y</code>	Is <code>x</code> greater than or equal to <code>y</code> ?
<code>x &lt;= y</code>	Is <code>x</code> less than or equal to <code>y</code> ?
<code>x == y</code>	Is <code>x</code> equal to <code>y</code> ?
<code>x != y</code>	Is <code>x</code> not equal to <code>y</code> ?

### The `>=` and `<=` Operators

Two of the operators, `>=` and `<=`, test for more than one relationship. The `>=` operator determines whether the operand on its left is greater than *or* equal to the operand on its right. The `<=` operator determines whether the operand on its left is less than *or* equal to the operand on its right.

For example, assume the variable `a` is assigned 4. All the following expressions are true:

```
a >= 4
a >= 2
8 >= a
a <= 4
a <= 9
4 <= a
```

### The `==` Operator

The `==` operator determines whether the operand on its left is equal to the operand on its right. If the values of both operands are the same, the expression is true. Assuming that `a` is 4, the expression `a == 4` is true and the expression `a == 2` is false.



**NOTE:** The equality operator is two `=` symbols together. Don't confuse this operator with the assignment operator, which is one `=` symbol.

### The `!=` Operator

The `!=` operator is the not equal to operator. It determines whether the operand on its left is not equal to the operand on its right, which is the opposite of the `==` operator. As before, assuming `a` is 4, `b` is 6, and `c` is 4, both `a != b` and `b != c` are true because `a` is not equal to `b` and `b` is not equal to `c`. However, `a != c` is false because `a` is equal to `c`.

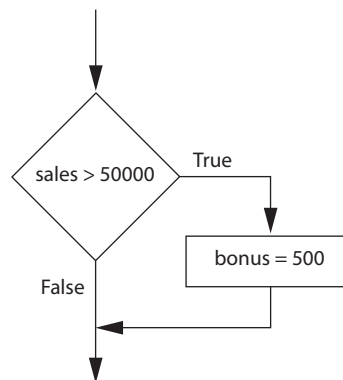
## Putting It All Together

Let's look at the following example of the `if` statement:

```
if (sales > 50000)
{
    bonus = 500;
}
```

This statement uses the `>` operator to determine whether `sales` is greater than 50,000. If the expression `sales > 50000` is true, the variable `bonus` is assigned 500. If the expression is false, however, the assignment statement is skipped. Figure 4-3 shows a flowchart for this section of code.

**Figure 4-3** Example decision structure

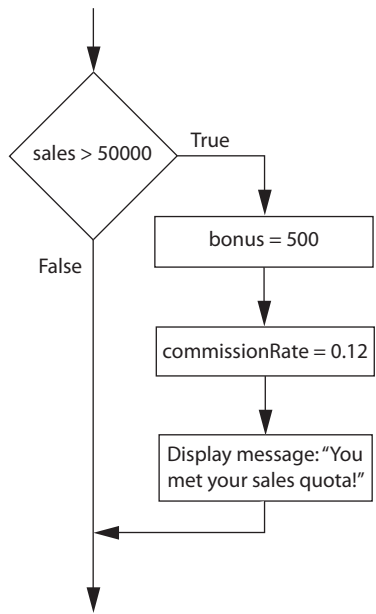


The following code sample conditionally executes three statements. Figure 4-4 shows a flowchart for this section of code.

```
if (sales > 50000)
{
    bonus = 500;
    commissionRate = 0.12;
    MessageBox.Show("You met your sales quota!");
}
```

When you write an `if` statement, Visual Studio automatically indents the conditionally executed statements, as shown in the previous examples. The indentation is not required, but it makes the code easier to read and debug. By indenting the conditionally executed statements, you visually set them apart from the surrounding code. This allows you to tell at a glance what part of the program is controlled by the `if` statement. Most programmers use this style of indentation when writing `if` statements.

**Figure 4-4** Example decision structure



VideoNote

**Tutorial 4-1:**  
Completing the *Test Score Average* application



### Tutorial 4-1: Completing the *Test Score Average* Application

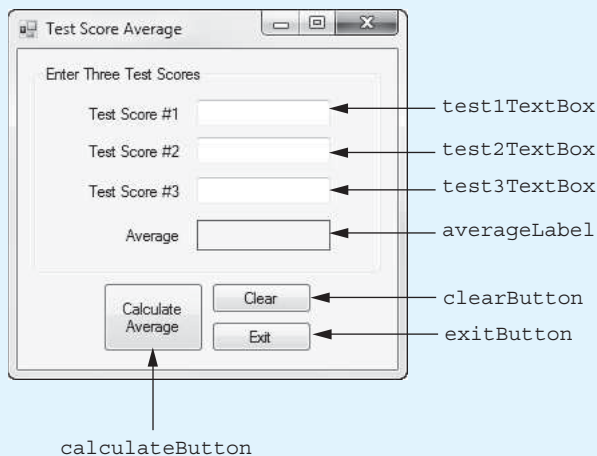
In this tutorial you will complete an application that allows the user to enter three test scores and calculates the average of the test scores. If the average is greater than 95, the application also displays a message congratulating the user.

To save time, the project has already been started for you, and the application’s form has already been created. To complete the project, follow the steps in this tutorial.

**Step 1:** Start Visual Studio (or Visual Studio Express). Open the project named *Test Score Average* in the *Chap04* folder of this book’s Student Sample Programs, available for download at [www.pearsonhighered.com/gaddis](http://www.pearsonhighered.com/gaddis).

**Step 2:** Open the Form1 form in the *Designer*. The form is shown, along with the names of the important controls, in Figure 4-5.

**Figure 4-5** The *Test Score Average* form



**Step 3:** Now you will create the Click event handlers for the Button controls. At the end of this tutorial, Program 4-1 shows the completed code for the form. You will be instructed to refer to Program 4-1 as you write the event handlers.

In the *Designer*, double-click the `calculateButton` control. This will open the code editor, and you see an empty event handler named `calculateButton_Click`. Complete the `calculateButton_Click` event handler by typing the code shown in lines 22–49 in Program 4-1.

Let's take a closer look at the code:

**Line 22:** This is the beginning of a `try-catch` statement. The `try` block appears in lines 24–43, and the `catch` block appears in lines 47–48. The purpose of this `try-catch` statement is to gracefully respond if the user enters invalid input for any of the test scores. If any of the statements in lines 28, 29, and 30 throw an exception, the program does not crash. Instead, it jumps to the `catch` block, and line 48 displays an error message.

**Line 24:** This statement declares a constant `double` named `HIGH_SCORE`, set to the value 95.0. We use this constant to determine whether the average is high. If the average is greater than this constant, the program displays a message congratulating the user.

**Line 25:** This statement declares the following `double` variables: `test1`, `test2`, `test3`, and `average`. The variables hold the three test scores and the average test score.

**Line 28:** This statement converts the `test1TextBox` control's `Text` property to a `double` and assigns the result to the `test1` variable.

**Line 29:** This statement converts the `test2TextBox` control's `Text` property to a `double` and assigns the result to the `test2` variable.

**Line 30:** This statement converts the `test3TextBox` control's `Text` property to a `double` and assigns the result to the `test3` variable.

**Line 33:** This statement calculates the average of the `test1`, `test2`, and `test3` variables and assigns the result to the `average` variable.

**Line 36:** This statement converts the `average` variable to a string (rounded to 1 decimal place) and assigns the result to the `averageLabel1` control's `Text` property.

**Line 40:** This `if` statement determines whether `average` is greater than `HIGH_SCORE`. If it is, the statement in line 42 is executed, displaying a message box with a congratulatory message. If `average` is not greater than `HIGH_SCORE`, the statement in line 42 is skipped.

**Step 4:** Switch your view back to the *Designer* and double-click the `clearButton` control. In the code editor you will see an empty event handler named `clearButton_Click`. Complete the `clearButton_Click` event handler by typing the code shown in lines 54–61 in Program 4-1.

**Lines 55–57:** Each of these statements assigns an empty string ("") to the `Text` property of one of the `TextBox` controls. When these statements have finished executing, the `TextBox` controls appear empty.

**Line 58:** This statement assigns an empty string ("") to the `averageLabel1` control's `Text` property. After the statement has executed, the label appears empty.

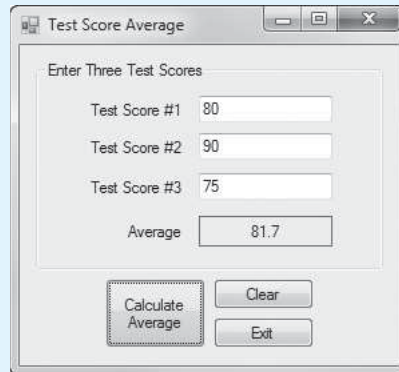
**Line 61:** This statement sets the focus to the `test1TextBox` control. This makes it more convenient for the user to start entering a new set of test scores.

**Step 5:** Switch your view back to the *Designer* and double-click the `exitButton` control. In the code editor you will see an empty event handler named `exitButton_Click`. Complete the `exitButton_Click` event handler by typing the code shown in lines 66–67 in Program 4-1.

**Step 6:** Save the project. Then, press **F5** on the keyboard or click the *Start Debugging* button (▶) on the toolbar to compile and run the application.

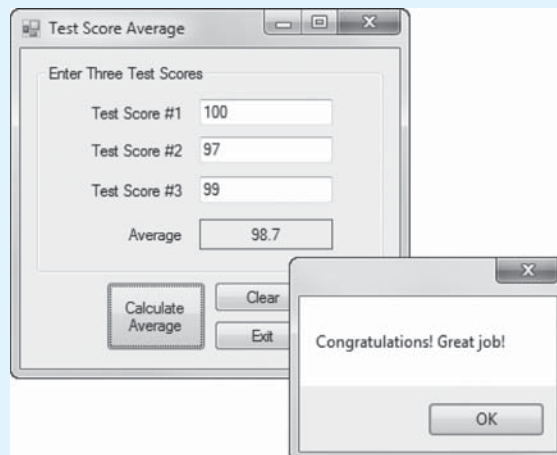
First, enter the following test scores in the TextBoxes: **80**, **90**, and **75**. Click the *Calculate Average* button and the average should appear as shown in Figure 4-6.

**Figure 4-6** Average displayed



Next, click the *Clear* button to clear the TextBoxes and the average. Now, enter the following test scores in the TextBoxes: **100**, **97**, and **99**. Click the *Calculate Average* button. This time, in addition to displaying the average, the application displays the message box shown in Figure 4-7.

**Figure 4-7** Average and message displayed



Continue to test the application as you wish. When you are finished, click the *Exit* button, and the form should close.

**Program 4-1** Completed Form1 code for the *Test Score Average* application

```

1 using System;
2 using System.Collections.Generic;
3 using System.ComponentModel;
4 using System.Data;
5 using System.Drawing;
6 using System.Linq;
7 using System.Text;

```

```
8 using System.Threading.Tasks;
9 using System.Windows.Forms;
10
11 namespace Test_Score_Average
12 {
13     public partial class Form1 : Form
14     {
15         public Form1()
16         {
17             InitializeComponent();
18         }
19
20         private void calculateButton_Click(object sender, EventArgs e)
21         {
22             try
23             {
24                 const double HIGH_SCORE = 95.0;          // High Score value
25                 double test1, test2, test3, average; // Variables
26
27                 // Get the test scores from the TextBoxes.
28                 test1 = double.Parse(test1TextBox.Text);
29                 test2 = double.Parse(test2TextBox.Text);
30                 test3 = double.Parse(test3TextBox.Text);
31
32                 // Calculate the average test score.
33                 average = (test1 + test2 + test3) / 3.0;
34
35                 // Display the average, rounded to 2 decimal places.
36                 averageLabel.Text = average.ToString("n1");
37
38                 // If the average is a high score, congratulate
39                 // the user with a message box.
40                 if (average > HIGH_SCORE)
41                 {
42                     MessageBox.Show("Congratulations! Great job!");
43                 }
44             }
45             catch (Exception ex)
46             {
47                 // Display the default error message.
48                 MessageBox.Show(ex.Message);
49             }
50         }
51
52         private void clearButton_Click(object sender, EventArgs e)
53         {
54             // Clear the TextBoxes and the averageLabel control.
55             test1TextBox.Text = "";
56             test2TextBox.Text = "";
57             test3TextBox.Text = "";
58             averageLabel.Text = "";
59
60             // Reset the focus to test1.
61             test1TextBox.Focus();
62         }
63
64         private void exitButton_Click(object sender, EventArgs e)
65         {
66             // Close the form.
```

```

67         this.Close();
68     }
69 }
70 }

```

## ✓ Checkpoint

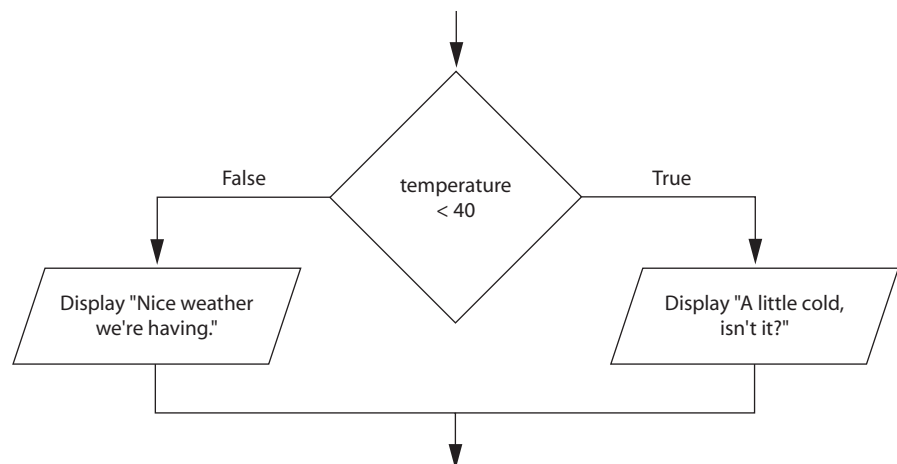
- 4.1 What is a control structure?
- 4.2 What is a decision structure?
- 4.3 What is a single-alternative decision structure?
- 4.4 What is a Boolean expression?
- 4.5 What types of relationships between numeric values can you test with relational operators?
- 4.6 Write an `if` statement that determines whether the variable `y` is equal to 20. If it is, assign 0 to the variable `x`.
- 4.7 Write an `if` statement that determines whether the variable `sales` is greater than or equal to 10,000. If it is, assign 0.2 to the variable `commissionRate`.

## 4.2 The `if-else` Statement

**CONCEPT:** An `if-else` statement will execute one block of statements if its Boolean expression is true or another block if its Boolean expression is false.

The previous section introduced the single-alternative decision structure (the `if` statement), which has one alternative path of execution. Now we will look at the **dual-alternative decision structure**, which has two possible paths of execution—one path is taken if the Boolean expression is true, and the other path is taken if the Boolean expression is false. Figure 4-8 shows an example flowchart for a dual-alternative decision structure.

**Figure 4-8** A dual-alternative decision structure



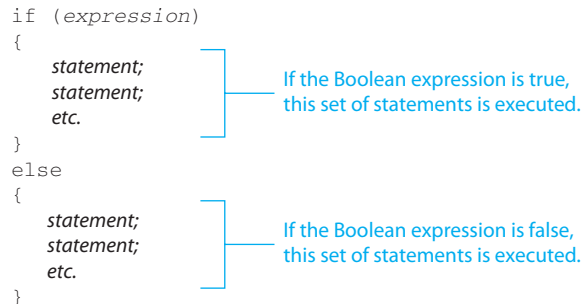
The decision structure in the flowchart tests the expression `temperature < 40`. If this expression is true, the message “A little cold, isn’t it?” is displayed. If the expression is false, the message “Nice weather we’re having.” is displayed.

In code we write a dual-alternative decision structure as an `if-else` statement. Here is the general format of the `if-else` statement:

```

if (expression)
{
    statement;
    statement;
    etc.
}
else
{
    statement;
    statement;
    etc.
}

```



An `if-else` statement has two parts: an `if` clause and an `else` clause. Just like a regular `if` statement, the `if-else` statement tests a Boolean expression. If the Boolean expression is true, the set of statements following the `if` clause is executed. If the Boolean expression is false, the set of statements following the `else` clause is executed.

The `if-else` statement has two sets of conditionally executed statements. One set is executed only under the condition that the Boolean expression is true, and the other set is executed only under the condition that the Boolean expression is false. Under no circumstances are both sets of conditionally executed statements executed.

If either set of conditionally executed statements contains only one statement, the curly braces are not required. For example, the following general format shows only one statement following the `if` clause and only one statement following the `else` clause:

```

if (expression)
    statement;
else
    statement;

```

Although the curly braces are not required when there is only one conditionally executed statement, it is still a good idea to use them, as shown in the following general format:

```

if (expression)
{
    statement;
}
else
{
    statement;
}

```

When we discussed the regular `if` statement, we mentioned that this is a good style of programming because it cuts down on errors. If there is more than one conditionally executed statement following either the `if` clause or the `else` clause, those statements *must* be enclosed in curly braces. If you get into the habit of always enclosing the conditionally executed statements in a set of curly braces, it’s less likely that you will forget them.

In Tutorial 4-2 you will complete an application that uses an `if-else` statement.





VideoNote

**Tutorial 4-2:**  
Completing the *Payroll with Overtime* application



## Tutorial 4-2: Completing the *Payroll with Overtime* Application

At a particular business, if an employee works more than 40 hours in a week, it is said that the employee has worked *overtime*. For example, an employee that has worked 45 hours in a week has worked 5 overtime hours. Employees that work overtime get paid their regular hourly pay rate for the first 40 hours plus 1.5 times their regular hourly pay rate for all hours over 40. In this tutorial you will complete a payroll application that calculates an employee’s gross pay, including overtime pay.

The application allows the user to enter the number of hours worked and the hourly pay rate into TextBoxes. When the user clicks a button, the gross pay is calculated in the following manner:

If the hours worked is greater than 40:

$$\begin{aligned} \text{base pay} &= \text{hourly pay rate} \times 40 \\ \text{overtime hours} &= \text{hours worked} - 40 \\ \text{overtime pay} &= \text{overtime hours} \times \text{hourly pay rate} \times 1.5 \\ \text{gross pay} &= \text{base pay} + \text{overtime pay} \end{aligned}$$

Else:

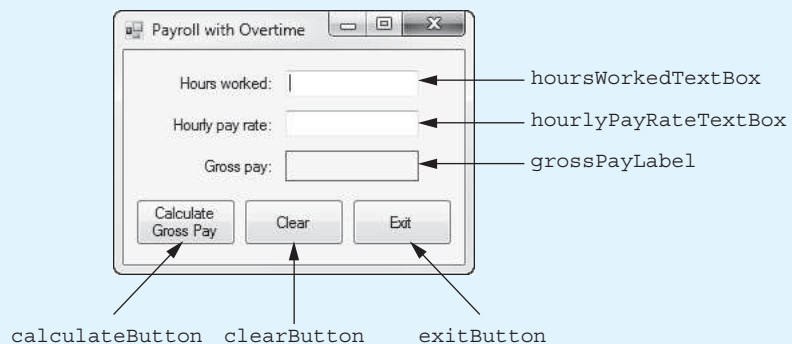
$$\text{gross pay} = \text{hours worked} \times \text{hourly pay rate}$$

To save time, the project has already been started for you, and the application’s form has already been created. To complete the project, follow the steps in this tutorial.

**Step 1:** Start Visual Studio (or Visual Studio Express). Open the project named *Payroll with Overtime* in the *Chap04* folder of this book’s Student Sample Programs.

**Step 2:** Open the Form1 form in the *Designer*. The form is shown, along with the names of the important controls, in Figure 4-9.

**Figure 4-9** The *Payroll with Overtime* form



**Step 3:** Now you will create the Click event handlers for the Button controls. At the end of this tutorial, Program 4-2 shows the completed code for the form. You will be instructed to refer to Program 4-2 as you write the event handlers.

In the *Designer*, double-click the `calculateButton` control. This opens the code editor, and you see an empty event handler named `calculateButton_Click`. Complete the `calculateButton_Click` event handler by typing the code shown in lines 22– 69 in Program 4-2.

Let's take a closer look at the code:

**Line 22:** This is the beginning of a `try-catch` statement. The `try` block appears in lines 24–63, and the `catch` block appears in lines 67–68. The purpose of this `try-catch` statement is to gracefully respond if the user enters invalid input. If an exception is thrown by any statement inside the `try` block, the program jumps to the `catch` block, and line 68 displays an error message.

**Lines 25–26:** These statements declare the following named constants:

- `BASE_HOURS`, a constant `decimal` set to the value 40. This is the number of hours an employee can work in a week without getting overtime pay.
- `OT_MULTIPLIER`, a constant `decimal` set to the value 1.5. This is the pay rate multiplier for overtime hours.

**Lines 29–34:** These statements declare the following variables:

- `hoursWorked`, a `decimal` variable to hold the number of hours worked
- `hourlyPayRate`, a `decimal` variable to hold the hourly pay rate
- `basePay`, a `decimal` variable to hold the pay for 40 or less hours
- `overtimeHours`, a `decimal` variable to hold the number of overtime hours worked
- `overtimePay`, a `decimal` variable to hold the amount of overtime pay
- `grossPay`, a `decimal` variable to hold the gross pay

**Line 37:** This statement converts the `hoursWorkedTextBox` control's `Text` property to a `decimal` and assigns the result to the `hoursWorked` variable.

**Line 38:** This statement converts the `hourlyPayRateTextBox` control's `Text` property to a `decimal` and assigns the result to the `hourlyPayRate` variable.

**Line 41:** This `if` statement determines whether `hoursWorked` is greater than `BASE_HOURS` (40). If so, the statements in lines 43–54 are executed. Otherwise, the statements in lines 58–59 are executed.

**Lines 43–54:** These statements, which are executed only if the hours worked are greater than 40, make all the necessary calculations to determine gross pay with overtime:

- Line 44 calculates the base pay, which is the amount of pay for the first 40 hours.
- Line 47 calculates the number of overtime hours, which is the number of hours over 40.
- Lines 50 and 51 calculate the amount of overtime pay, which is the pay for the hours over 40.
- Line 54 calculates the gross pay, which is the amount of base pay plus the amount of overtime pay. The result is assigned to the `grossPay` variable.

**Line 59:** This statement, which is executed only if the hours worked are 40 or less, calculates the gross pay and assigns the result to the `grossPay` variable.

**Line 63:** This statement converts the value of the `grossPay` variable to a string, formatted as currency, and assigns the result to the `grossPayLabel` control's `Text` property.

**Step 4:** Switch your view back to the *Designer* and double-click the `clearButton` control. In the code editor you see an empty event handler named `clearButton_Click`. Complete the `clearButton_Click` event handler by typing the code shown in lines 74–80 in Program 4-2. These statements clear the `TextBoxes` and the `grossPayLabel` control and sets the focus to the `hoursWorkedTextBox` control.

**Step 5:** Switch your view back to the *Designer* and double-click the `exitButton` control. In the code editor you see an empty event handler named `exitButton_Click`. Complete the `exitButton_Click` event handler by typing the code shown in lines 85–86 in Program 4-2.

**Step 6:** Save the project and run the application. First, enter 40 for the number of hours worked and 20 for the hourly pay rate. Click the *Calculate Gross Pay* button, and the application should display \$800.00 as the gross pay. No overtime hours were worked, so the gross pay is simply calculated as hours worked  $\times$  hourly pay rate.

Click the *Clear* button. Enter 50 for the number of hours worked and 20 for the hourly pay rate. Click the *Calculate Gross Pay* button, and the application should display \$1,100.00 as the gross pay. This time, more than 40 hours were worked, so the application calculated the gross pay to include overtime pay.

Continue to test the application as you wish. When you are finished, click the *Exit* button and the form should close.

---

**Program 4-2** Completed Form1 code for the *Payroll with Overtime application*

```

1 using System;
2 using System.Collections.Generic;
3 using System.ComponentModel;
4 using System.Data;
5 using System.Drawing;
6 using System.Linq;
7 using System.Text;
8 using System.Threading.Tasks;
9 using System.Windows.Forms;
10
11 namespace Payroll_with_Overtime
12 {
13     public partial class Form1 : Form
14     {
15         public Form1()
16         {
17             InitializeComponent();
18         }
19
20         private void calculateButton_Click(object sender, EventArgs e)
21         {
22             try
23             {
24                 // Named constants
25                 const decimal BASE_HOURS = 40m;
26                 const decimal OT_MULTIPLIER = 1.5m;
27
28                 // Local variables
29                 decimal hoursWorked; // Number of hours worked
30                 decimal hourlyPayRate; // Hourly pay rate
31                 decimal basePay; // Pay not including overtime
32                 decimal overtimeHours; // overtime hours worked
33                 decimal overtimePay; // overtime pay
34                 decimal grossPay; // total gross pay
35
36                 // Get the hours worked and hourly pay rate.
37                 hoursWorked = decimal.Parse(hoursWorkedTextBox.Text);
38                 hourlyPayRate = decimal.Parse(hourlyPayRateTextBox.Text);

```

```

39
40         // Determine the gross pay.
41         if (hoursWorked > BASE_HOURS)
42         {
43             // Calculate the base pay (without overtime).
44             basePay = hourlyPayRate * BASE_HOURS;
45
46             // Calculate the number of overtime hours.
47             overtimeHours = hoursWorked - BASE_HOURS;
48
49             // Calculate the overtime pay.
50             overtimePay = overtimeHours * hourlyPayRate *
51                 OT_MULTIPLIER;
52
53             // Calculate the gross pay.
54             grossPay = basePay + overtimePay;
55         }
56         else
57         {
58             // Calculate the gross pay.
59             grossPay = hoursWorked * hourlyPayRate;
60         }
61
62         // Display the gross pay.
63         grossPayLabel.Text = grossPay.ToString("c");
64     }
65     catch (Exception ex)
66     {
67         // Display an error message.
68         MessageBox.Show(ex.Message);
69     }
70 }
71
72 private void clearButton_Click(object sender, EventArgs e)
73 {
74     // Clear the TextBoxes and gross pay label.
75     hoursWorkedTextBox.Text = "";
76     hourlyPayRateTextBox.Text = "";
77     grossPayLabel.Text = "";
78
79     // Reset the focus.
80     hoursWorkedTextBox.Focus();
81 }
82
83 private void exitButton_Click(object sender, EventArgs e)
84 {
85     // Close the form.
86     this.Close();
87 }
88 }
89 }

```

## Checkpoint

- 4.8 Describe how a dual alternative decision structure works.
- 4.9 In an if-else statement, under what circumstances do the statements that appear after the else clause execute?

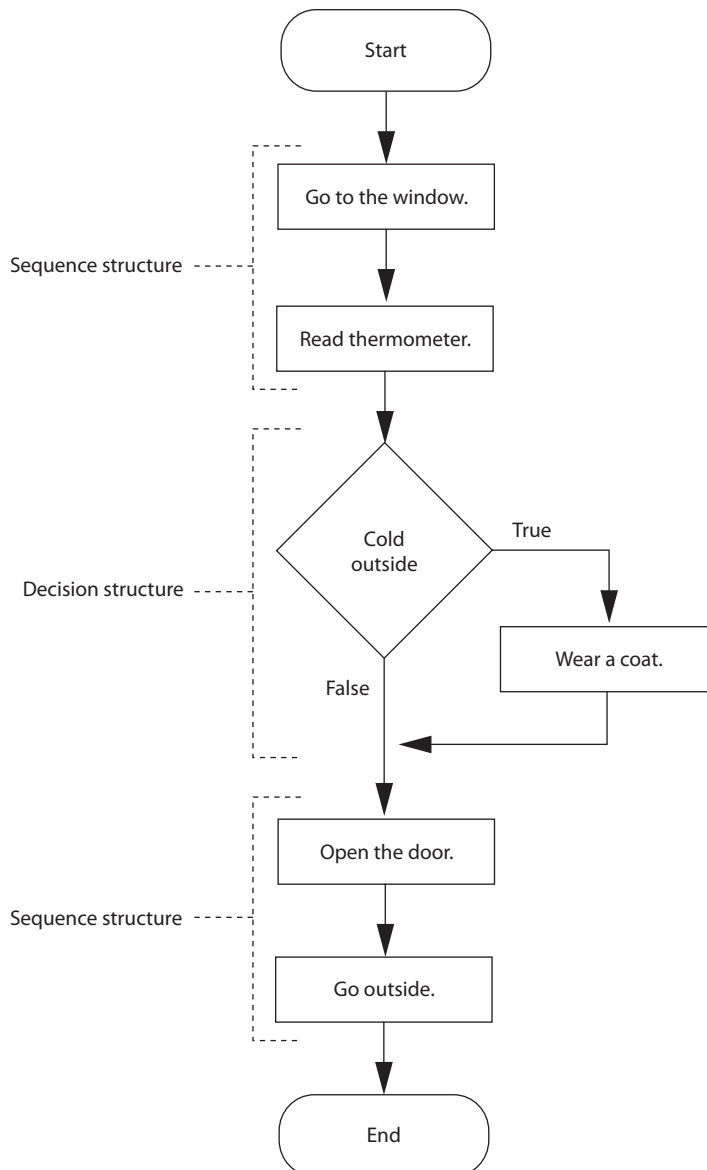
4.10 Write an `if-else` statement that works like this: If the `sales` variable is greater than or equal to 50,000, the `commissionRate` variable should be assigned the value 0.2. Otherwise, the `commissionRate` variable should be assigned the value 0.1.

## 4.3 Nested Decision Structures

**CONCEPT:** To test more than one condition, a decision structure can be nested inside another decision structure.

In Section 4.1, we mentioned that a control structure determines the order in which a set of statements execute. Programs are usually designed as combinations of different control structures. For example, Figure 4-10 shows a flowchart that combines a decision structure with two sequence structures.

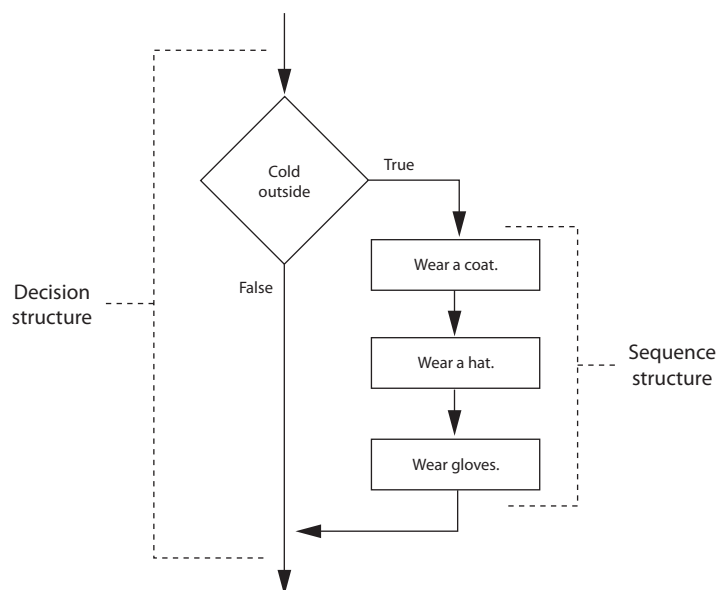
**Figure 4-10** Combining sequence structures with a decision structure



The flowchart in Figure 4-10 starts with a sequence structure. Assuming you have an outdoor thermometer in your window, the first step is *Go to the window*, and the next step is *Read thermometer*. A decision structure appears next, testing the condition *Cold outside*. If this is true, the action *Wear a coat* is performed. Another sequence structure appears next. The step *Open the door* is performed, followed by *Go outside*.

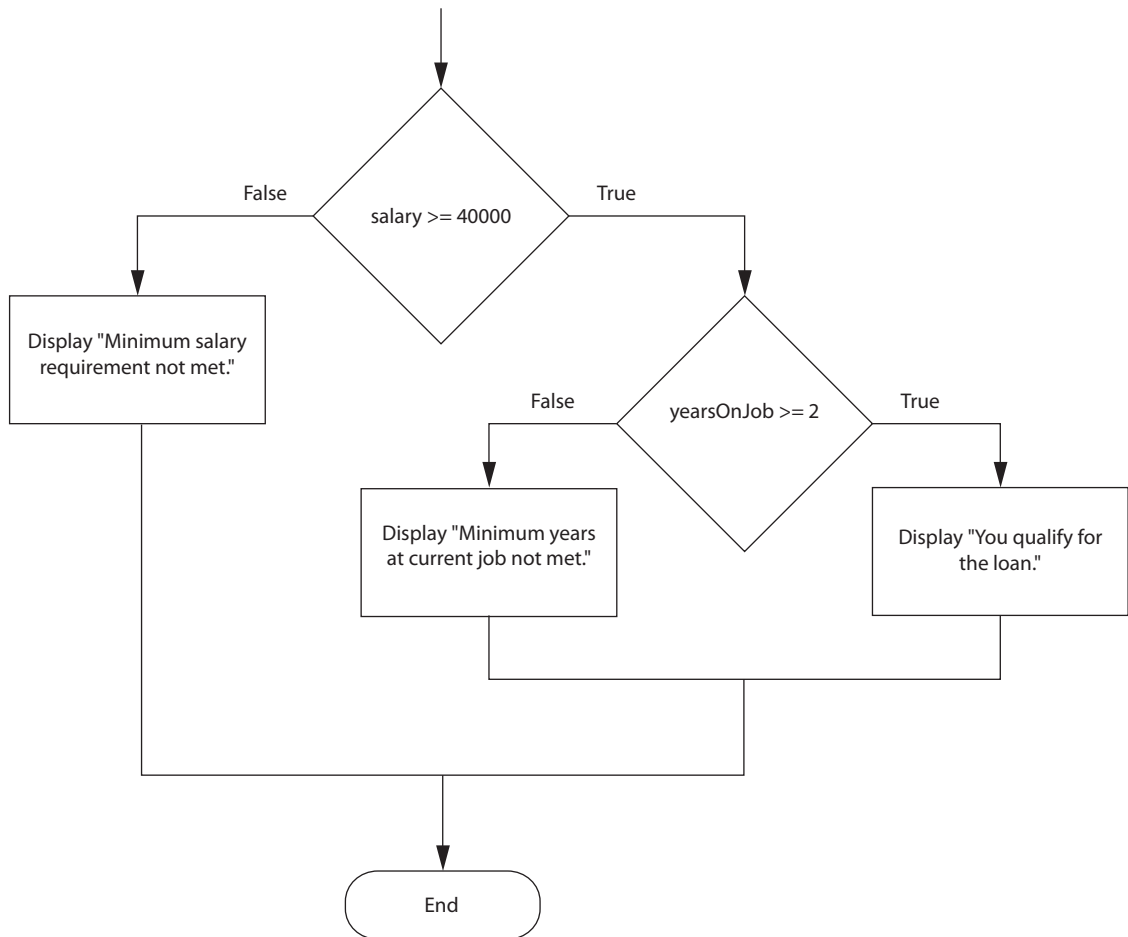
Quite often, structures must be nested inside other structures. For example, look at the partial flowchart in Figure 4-11. It shows a decision structure with a sequence structure nested inside. The decision structure tests the condition *Cold outside*. If that condition is true, the steps in the sequence structure are executed.

**Figure 4-11** A sequence structure nested inside a decision structure



You can also have **nested decision structures**, which are decision structures that appear inside other decision structures. This is commonly done in programs that need to test more than one condition. For example, consider a program that determines whether a bank customer qualifies for a loan. To qualify, two conditions must exist: (1) The customer must earn at least \$40,000 per year, and (2) the customer must have been employed at his or her current job for at least 2 years. Figure 4-12 shows a flowchart for an algorithm that could be used in such a program. Assume that the `salary` variable contains the customer's annual salary, and the `yearsOnJob` variable contains the number of years that the customer has worked on his or her current job.

If we follow the flow of execution, we see that the Boolean expression `salary >= 40000` is tested. If this expression is false, there is no need to perform further tests; we know that the customer does not qualify for the loan. If the expression is true, however, we need to test the second condition. This is done with a nested decision structure that tests the Boolean expression `yearsOnJob >= 2`. If this expression is true, then the customer qualifies for the loan. If this expression is false, then the customer does not qualify. In Tutorial 4-3 you create an application that performs this algorithm.

**Figure 4-12** A nested decision structure

VideoNote

**Tutorial 4-3:**  
Completing the *Loan Qualifier* application



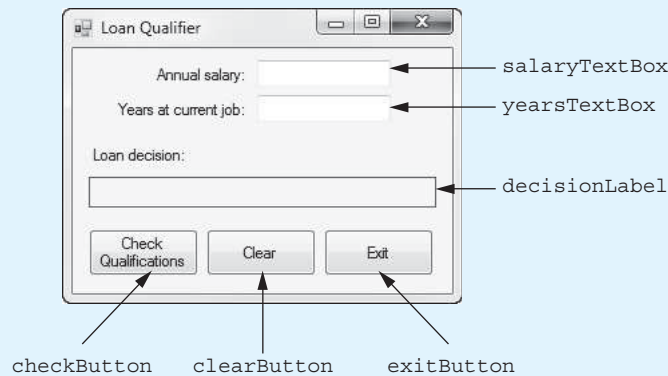
### Tutorial 4-3:

#### Completing the *Loan Qualifier* Application

In this tutorial you complete an application that determines whether a person qualifies for a loan. To qualify for the loan, the person must earn a salary of at least \$40,000 and must have been employed at his or her current job for at least 2 years.

To save time, the project has already been started for you, and the application's form has already been created. To complete the project, follow the steps in this tutorial.

- Step 1:** Start Visual Studio (or Visual Studio Express). Open the project named *Loan Qualifier* in the *Chap04* folder of this book's Student Sample Programs.
- Step 2:** Open the Form1 form in the *Designer*. The form is shown, along with the names of the important controls, in Figure 4-13.
- Step 3:** Now you will create the Click event handlers for the Button controls. At the end of this tutorial, Program 4-3 shows the completed code for the form. You will be instructed to refer to Program 4-3 as you write the event handlers.

**Figure 4-13** The *Loan Qualifier* form

In the *Designer*, double-click the `checkBoxButton` control. This opens the code editor, and you see an empty event handler named `checkBoxButton_Click`. Complete the `checkBoxButton_Click` event handler by typing the code shown in lines 22–62 in Program 4-3. Let’s take a closer look at the code:

**Line 22:** This is the beginning of a `try-catch` statement. The `try` block appears in lines 24–56, and the `catch` block appears in lines 60–61. The purpose of this `try-catch` statement is to gracefully respond if the user enters invalid input. If an exception is thrown by any statement inside the `try` block, the program jumps to the `catch` block, and line 61 displays an error message.

**Lines 25–26:** These statements declare the following named constants:

- `MINIMUM_SALARY`, a constant `decimal` set to the value 40,000, which is the minimum salary a person must earn to qualify for the loan
- `MINIMUM_YEARS_ON_JOB`, a constant `int` set to the value 2, which is the minimum number of years a person must have been at his or her current job to qualify for the loan

**Lines 29–30:** These statements declare the following variables:

- `salary`, a `decimal` variable to hold the salary
- `yearsOnJob`, an `int` variable to hold the number of years at the current job

**Lines 33–34:** These statements get the salary and years at the current job from the `TextBox` controls and assign those values to the `salary` and `yearsOnJob` variables.

**Line 37:** This `if` statement determines whether `salary` is greater than or equal to `MINIMUM_SALARY`. If so, the program continues at line 39. Otherwise, the program jumps to the `else` clause in line 51, and in lines 54–55 the string “Minimum salary requirement not met.” is assigned to the `decisionLabel` control’s `Text` property.

**Line 39:** This `if` statement determines whether `yearsOnJob` is greater than or equal to `MINIMUM_YEARS_ON_JOB`. If so, the program continues at line 42, where the string “You qualify for the loan.” is assigned to the `decisionLabel` control’s `Text` property. Otherwise, the program jumps to the `else` clause in line 44, and in lines 47–48 the string “Minimum years at current job not met.” is assigned to the `decisionLabel` control’s `Text` property.

**Step 4:** Switch your view back to the *Designer* and double-click the `clearButton` control. In the code editor you see an empty event handler named `clearButton_Click`. Complete the `clearButton_Click` event handler by typing the code shown in lines 67–73 in Program 4-3.



**Step 5:** Switch your view back to the *Designer* and double-click the `exitButton` control. In the code editor you see an empty event handler named `exitButton_Click`. Complete the `exitButton_Click` event handler by typing the code shown in lines 78–79 in Program 4-3.

**Step 6:** Save the project and run the application. First, enter 45000 for the salary and 1 for the years at current job. Click the *Check Qualifications* button, and the application should display the message “Minimum years at current job not met.” Click the *Clear* button. Enter 35000 for the salary and 5 for the years at current job. Click the *Check Qualifications* button, and the application should display the message “Minimum salary requirement not met.”

Click the *Clear* button. Enter 45000 for the salary and 5 for the years at current job. Click the *Check Qualifications* button, and the application should display the message “You qualify for the loan.”

Continue to test the application as you wish. When you are finished, click the *Exit* button and the form should close.

---

**Program 4-3** Completed Form1 code for the *Loan Qualifier* application

```

1 using System;
2 using System.Collections.Generic;
3 using System.ComponentModel;
4 using System.Data;
5 using System.Drawing;
6 using System.Linq;
7 using System.Text;
8 using System.Threading.Tasks;
9 using System.Windows.Forms;
10
11 namespace Loan_Qualifier
12 {
13     public partial class Form1 : Form
14     {
15         public Form1()
16         {
17             InitializeComponent();
18         }
19
20         private void checkButton_Click(object sender, EventArgs e)
21         {
22             try
23             {
24                 // Names constants
25                 const decimal MINIMUM_SALARY = 40000m;
26                 const int MINIMUM_YEARS_ON_JOB = 2;
27
28                 // Local variables
29                 decimal salary;
30                 int yearsOnJob;
31
32                 // Get the salary and years on the job.
33                 salary = decimal.Parse(salaryTextBox.Text);
34                 yearsOnJob = int.Parse(yearsTextBox.Text);
35
36                 // Determine whether the user qualifies.
37                 if (salary >= MINIMUM_SALARY)

```

```

38         {
39             if (yearsOnJob >= MINIMUM_YEARS_ON_JOB)
40             {
41                 // The user qualifies.
42                 decisionLabel.Text = "You qualify for the loan.";
43             }
44             else
45             {
46                 // The user does not qualify.
47                 decisionLabel.Text = "Minimum years at current " +
48                     "job not met.";
49             }
50         }
51     else
52     {
53         // The user does not qualify.
54         decisionLabel.Text = "Minimum salary requirement " +
55             "not met.";
56     }
57 }
58 catch (Exception ex)
59 {
60     // Display an error message.
61     MessageBox.Show(ex.Message);
62 }
63 }
64
65 private void clearButton_Click(object sender, EventArgs e)
66 {
67     // Clear the TextBoxes and the decisionLabel.
68     salaryTextBox.Text = "";
69     yearsTextBox.Text = "";
70     decisionLabel.Text = "";
71
72     // Reset the focus.
73     salaryTextBox.Focus();
74 }
75
76 private void exitButton_Click(object sender, EventArgs e)
77 {
78     // Close the form.
79     this.Close();
80 }
81 }
82 }

```

## Indentation and Alignment in Nested Decision Structures

For debugging purposes, it's important to use proper alignment and indentation in a nested `if` statement. This makes it easier to see which actions are performed by each part of the structure. For example, the following code is functionally equivalent to lines 37–56 in Program 4-3. Although this code is logically correct, it would be very difficult to debug because it is not properly indented.

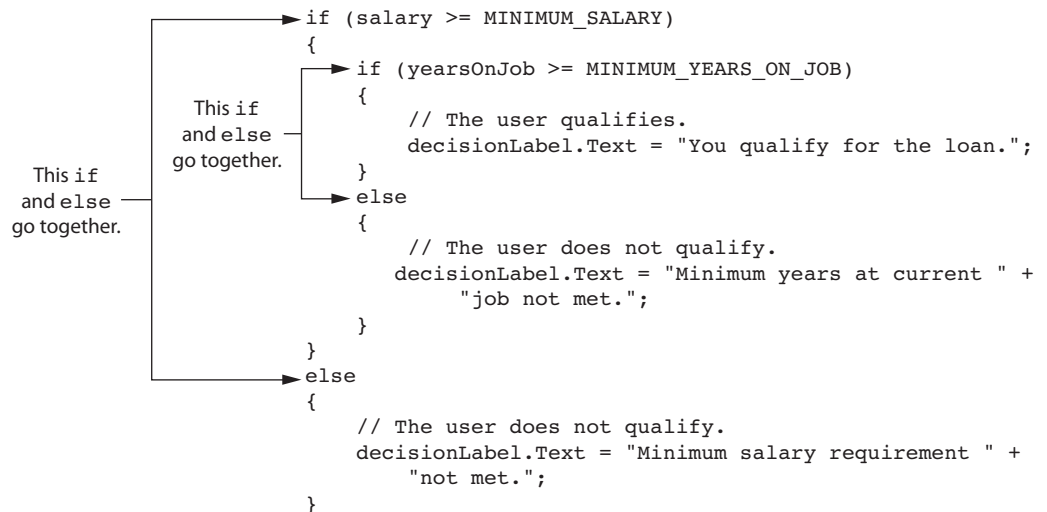
```

if (salary >= MINIMUM_SALARY)
{
if (yearsOnJob >= MINIMUM_YEARS_ON_JOB)
{
// The user qualifies.
decisionLabel.Text = "You qualify for the loan.";
}
else
{
// The user does not qualify.
decisionLabel.Text = "Minimum years at current " +
    "job not met.";
}
}
else
{
// The user does not qualify.
decisionLabel.Text = "Minimum salary requirement " +
    "not met.";
}
}

```

Fortunately, Visual Studio automatically indents and aligns the statements in a decision structure. Proper indentation and alignment makes it easier to see which `if` and `else` clauses belong together, as shown in Figure 4-14.

**Figure 4-14** Alignment of `if` and `else` clauses

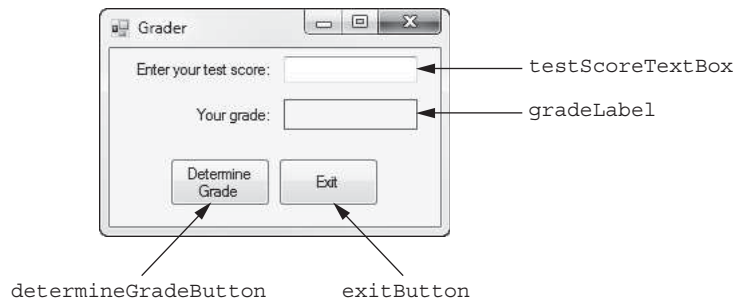


## Testing a Series of Conditions

In Tutorial 4-3 you saw how a program can use nested decision structures to test more than one Boolean expression. It is not uncommon for a program to have a series of Boolean expressions to test and then perform an action, depending on which expression is true. One way to accomplish this is to have a decision structure with numerous other decision structures nested inside it. For example, look at the *Grader* application in the *Chap04* folder of this book's Student Sample Programs.

Figure 4-15 shows the application's form, with the names of several controls. When you run the application, you enter a numeric test score into the `testScoreTextBox` control and click the `determineGradeButton` control; a grade is then displayed in the `gradeLabel` control.

**Figure 4-15** The *Grader* application's form



The following 10-point grading scale is used to determine the grade:

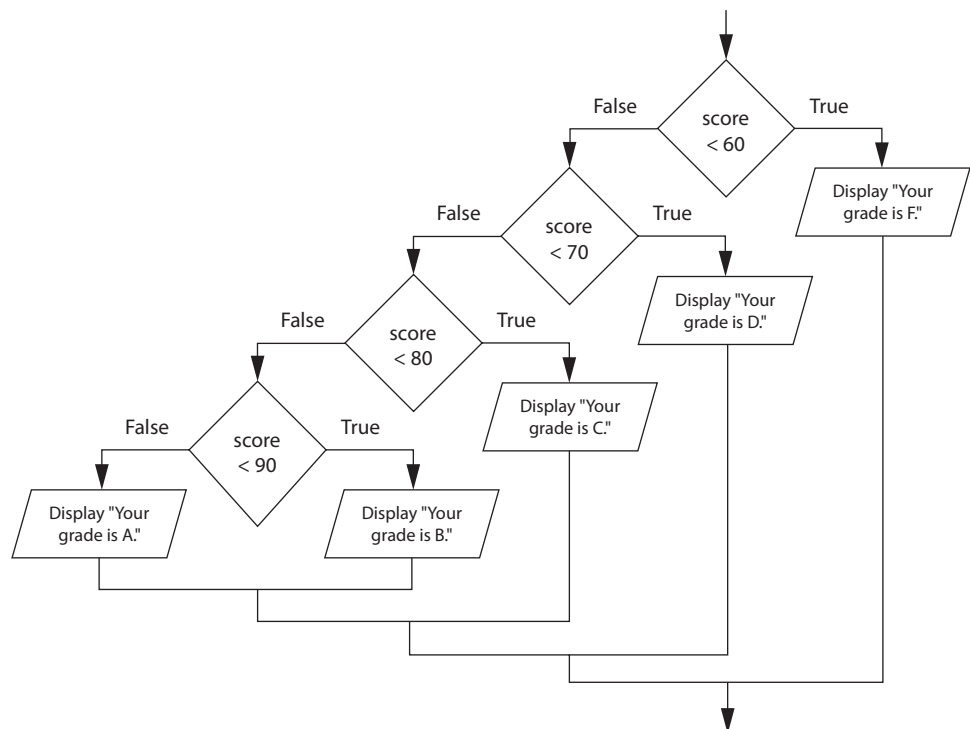
Test Score	Grade
90 and above	A
80–89	B
70–79	C
60–69	D
Below 60	F

The logic of determining the grade can be expressed like this:

- If the test score is less than 60, then the grade is "F."
- Otherwise, if the test score is less than 70, then the grade is "D."
- Otherwise, if the test score is less than 80, then the grade is "C."
- Otherwise, if the test score is less than 90, then the grade is "B."
- Otherwise, the grade is "A."

This logic requires several nested decision structures, as shown in the flowchart in Figure 4-16.

**Figure 4-16** Nested decision structure to determine a grade



Open the code editor and look at the `determineGradeButton_Click` event handler, shown in the following code sample. The nested decision structure appears in lines 12–41.

```

1 private void determineGradeButton_Click(object sender, EventArgs e)
2 {
3     try
4     {
5         // Variable to hold the test score.
6         double testScore;
7
8         // Get the test score.
9         testScore = double.Parse(testScoreTextBox.Text);
10
11        // Determine the grade.
12        if (testScore < 60)
13        {
14            gradeLabel.Text = "F";
15        }
16        else
17        {
18            if (testScore < 70)
19            {
20                gradeLabel.Text = "D";
21            }
22            else
23            {
24                if (testScore < 80)
25                {
26                    gradeLabel.Text = "C";
27                }
28                else
29                {
30                    if (testScore < 90)
31                    {
32                        gradeLabel.Text = "B";
33                    }
34                    else
35                    {
36                        gradeLabel.Text = "A";
37                    }
38                }
39            }
40        }
41    }
42    catch (Exception ex)
43    {
44        // Display an error message.
45        MessageBox.Show(ex.Message);
46    }
47 }

```

## The if-else-if Statement

Even though the *Grader* application previously shown is a simple example, the logic of the nested decision structure is fairly complex. C# provides a special version of the decision structure known as the **if-else-if statement**, which makes this type of logic simpler to write. You write the if-else-if statement using the following general format:

```

if (BooleanExpression_1)
{
    statement;
    statement;
    etc.
}
else if (BooleanExpression_2)
{
    statement;
    statement;
    etc.
}

Insert as many else if clauses as necessary...

else
{
    statement;
    statement;
    etc.
}

```

If *BooleanExpression\_1* is true, this set of statements is executed.

If *BooleanExpression\_2* is true, this set of statements is executed.

This set of statements is executed if none of the Boolean expressions are true.

When the statement executes, *BooleanExpression\_1* is tested. If *BooleanExpression\_1* is true, the set of statements that immediately follows is executed, and the rest of the structure is skipped. If *BooleanExpression\_1* is false, however, the program jumps to the very next `else if` clause and tests *BooleanExpression\_2*. If it is true, the set of statements that immediately follows is executed, and the rest of the structure is then skipped. This process continues until a Boolean expression is found to be true, or no more `else if` clauses are left. If none of the Boolean expressions are true, the set of statements following the final `else` clause is executed.

For example, look at the *Grader2* application in the *Chap04* folder of this book's Student Sample Programs. This application works just like the *Grader* application that was previously discussed. The user enters a numeric test score, and the application displays a grade. Its form is identical to the form shown in Figure 4-15. The *Grader2* application, however, uses an `if-else-if` statement to determine the grade instead of nested `if-else` statements. The *Grader2* application's `determineGradeButton_Click` event handler is shown here:

```

1 private void determineGradeButton_Click(object sender, EventArgs e)
2 {
3     try
4     {
5         // Variable to hold the test score.
6         double testScore;
7
8         // Get the test score.
9         testScore = double.Parse(testScoreTextBox.Text);
10
11        // Determine the grade.
12        if (testScore < 60)
13        {
14            gradeLabel.Text = "F";
15        }
16        else if (testScore < 70)
17        {
18            gradeLabel.Text = "D";
19        }
20        else if (testScore < 80)
21        {
22            gradeLabel.Text = "C";
23        }
24        else if (testScore < 90)
25        {
26            gradeLabel.Text = "B";
27        }
28        else

```

```

29         {
30             gradeLabel.Text = "A";
31         }
32     }
33     catch (Exception ex)
34     {
35         // Display an error message.
36         MessageBox.Show(ex.Message);
37     }
38 }

```

Notice the alignment and indentation that is used with the `if-else-if` statement: The `if`, `else if`, and `else` clauses are all aligned, and the conditionally executed statements are indented.

You never have to use the `if-else-if` statement because its logic can be coded with nested `if-else` statements. However, a long series of nested `if-else` statements has two particular disadvantages when you are debugging code:

- The code can grow complex and become difficult to understand.
- Because indenting is important in nested statements, a long series of nested `if-else` statements can become too long to be displayed on the computer screen without horizontal scrolling. Also, long statements tend to wrap around when printed on paper, making the code even more difficult to read.

The logic of an `if-else-if` statement is usually easier to follow than a long series of nested `if-else` statements. And, because all the clauses are aligned in an `if-else-if` statement, the lengths of the lines in the statement tend to be shorter.



## Checkpoint

4.11 Convert the following set of nested `if-else` statements to an `if-else if` statement:

```

if (number == 1)
{
    MessageBox.Show("One");
}
else
{
    if (number == 2)
    {
        MessageBox.Show("Two");
    }
    else
    {
        if (number == 3)
        {
            MessageBox.Show("Three");
        }
        else
        {
            MessageBox.Show("Unknown");
        }
    }
}
}

```

## 4.4 Logical Operators

**CONCEPT:** The logical AND operator (&&) and the logical OR operator (||) allow you to connect multiple Boolean expressions to create a compound expression. The logical NOT operator (!) reverses the truth of a Boolean expression.

The C# language provides a set of operators known as **logical operators**, which you can use to create complex Boolean expressions. Table 4-3 describes these operators.

**Table 4-3** Logical operators

Operator	Meaning
&&	This is the logical AND operator. It connects two Boolean expressions into one compound expression. Both subexpressions must be true for the compound expression to be true.
	This is the logical OR operator. It connects two Boolean expressions into one compound expression. One or both subexpressions must be true for the compound expression to be true. It is necessary for only one of the subexpressions to be true, and it does not matter which.
!	This is the logical NOT operator. It is a unary operator, meaning it works with only one operand. The operand must be a Boolean expression. The not operator reverses the truth of its operand. If it is applied to an expression that is true, the operator returns false. If it is applied to an expression that is false, the operator returns true.

Table 4-4 shows examples of several compound Boolean expressions that use logical operators.

**Table 4-4** Compound Boolean expressions using logical operators

Expression	Meaning
<code>x &gt; y &amp;&amp; a &lt; b</code>	Is <code>x</code> greater than <code>y</code> AND is <code>a</code> less than <code>b</code> ?
<code>x == y    x == z</code>	Is <code>x</code> equal to <code>y</code> OR is <code>x</code> equal to <code>z</code> ?
<code>! (x &gt; y)</code>	Is the expression <code>x &gt; y</code> NOT true?

### The && Operator

The && operator is the **logical AND operator**. It takes two Boolean expressions as operands and creates a compound Boolean expression that is true only when both subexpressions are true. The following is an example of an `if` statement that uses the && operator:

```
if (temperature < 20 && minutes > 12)
{
    MessageBox.Show("The temperature is in the danger zone.");
}
```

In this statement, the two Boolean expressions `temperature < 20` and `minutes > 12` are combined into a compound expression. The `MessageBox.Show` statement is executed only if `temperature` is less than 20 *and* `minutes` is greater than 12. If either of the Boolean subexpressions is false, the compound expression is false and the message is not displayed.



Table 4-5 shows a truth table for the `&&` operator. The truth table lists expressions showing all the possible combinations of true and false connected with the `&&` operator. The resulting values of the expressions are also shown.

**Table 4-5** Truth table for the AND operator

Expression	Value of the Expression
<code>true &amp;&amp; false</code>	<code>false</code>
<code>false &amp;&amp; true</code>	<code>false</code>
<code>false &amp;&amp; false</code>	<code>false</code>
<code>true &amp;&amp; true</code>	<code>true</code>

As the table shows, both sides of the `&&` operator must be true for the operator to return a true value.

## The `||` Operator

The `||` operator is the **logical OR operator**. It takes two Boolean expressions as operands and creates a compound Boolean expression that is true when either of the subexpressions is true. The following is an example of an `if` statement that uses the `||` operator:

```
if (temperature < 20 || temperature > 100)
{
    MessageBox.Show("The temperature is in the danger zone.");
}
```

The `MessageBox.Show` statement executes only if `temperature` is less than 20 *or* `temperature` is greater than 100. If either subexpression is true, the compound expression is true. Table 4-6 shows a truth table for the `||` operator.

**Table 4-6** Truth table for the `||` operator

Expression	Value of the Expression
<code>true    false</code>	<code>true</code>
<code>false    true</code>	<code>true</code>
<code>false    false</code>	<code>false</code>
<code>true    true</code>	<code>true</code>

All it takes for an `||` expression to be true is for one side of the `||` operator to be true. It doesn't matter if the other side is false or true.

## Short-Circuit Evaluation

Both the `&&` and `||` operators perform **short-circuit evaluation**. Here is how it works with the `&&` operator: if the expression on the left side of the `&&` operator is false, the expression on the right side is not checked. Because the compound expression is false if only one of the subexpressions is false, it would waste CPU time to check the remaining expression. So, when the `&&` operator finds that the expression on its left is false, it short-circuits and does not evaluate the expression on its right.

Here's how short-circuit evaluation works with the `||` operator: if the expression on the left side of the `||` operator is true, the expression on the right side is not checked. Because it is necessary for only one of the expressions to be true, it would waste CPU time to check the remaining expression.

## The ! Operator

The **! operator** is the **logical NOT operator**. It is a unary operator that takes a Boolean expression as its operand and reverses its logical value. In other words, if the expression is true, the ! operator returns false, and if the expression is false, the ! operator returns true. The following is an `if` statement using the NOT operator:

```
if ( !(temperature > 100) )
{
    MessageBox.Show("This is below the maximum temperature.");
}
```

First, the expression `(temperature > 100)` is tested and a value of either true or false is the result. Then the ! operator is applied to that value. If the expression `(temperature > 100)` is true, the ! operator returns false. If the expression `(temperature > 100)` is false, the ! operator returns true. The previous code is equivalent to asking “Is the temperature not greater than 100?”

Notice that in this example, we have put parentheses around the expression `temperature > 100`. This is necessary because the ! operator has higher precedence than the relational operators. If we do not put the parentheses around the expression `temperature > 100`, the ! operator will be applied just to the `temperature` variable.

Table 4-7 shows a truth table for the ! operator.

**Table 4-7** Truth table for the ! operator

Expression	Value of the Expression
! true	false
! false	true

## Precedence of the Logical Operators

We mentioned earlier that the ! operator has higher precedence than the relational operators. The `&&` and `||` logical operators have lower precedence than the relational operators. For example, look at the following expression:

```
creditScore > 700 || accountBalance > 9000
```

When this expression is evaluated, the `>` operators work first, and then the `||` operator works. The expression is the same as the following:

```
(creditScore > 700) || (accountBalance > 9000)
```

Many programmers choose to enclose the expressions that are to the left and the right of a logical operator in parentheses, as shown here. Even though the parentheses are not required in many situations, using them makes the compound expression easier to understand.

## Checking Numeric Ranges with Logical Operators

Sometimes you need to write code that determines whether a numeric value is within a specific range of values or outside a specific range of values. When determining whether a number is inside a range, it is best to use the `&&` operator. For example, the following `if` statement checks the value in `x` to determine whether it is in the range of 20 through 40:

```
if (x > 20 && x < 40)
{
    MessageBox.Show("The value is in the acceptable range.");
}
```

The compound Boolean expression being tested by this statement is true only when  $x$  is greater than 20 *and* less than 40. The value in  $x$  must be between the values of 20 and 40 for this compound expression to be true.

When determining whether a number is outside a range, it is best to use the `||` operator. The following statement determines whether  $x$  is outside the range of 20 through 40:

```
if (x < 20 || x > 40)
{
    MessageBox.Show("The value is outside the acceptable range.");
}
```

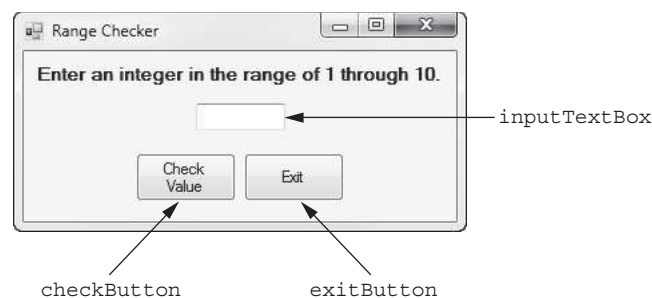
It is important not to get the logic of the logical operators confused when testing for a range of numbers. For example, the compound Boolean expression in the following code would never test true:

```
// This is an error!
if (x < 20 && x > 40)
{
    MessageBox.Show("The value is outside the acceptable range.");
}
```

Obviously,  $x$  cannot be less than 20 and at the same time be greater than 40.

Let's look at an example application that checks the range of a value entered by the user. Open the *Range Checker* application in the *Chap04* folder of this book's Student Sample Programs. Figure 4-17 shows the application's form, along with the names of some of the controls. When you run the application, you enter an integer into the `inputTextBox` control and click the `checkButton` control. If you enter a number in the range of 1 through 10, a message box appears letting you know that the number is acceptable. Otherwise, a message box appears letting you know that the number is *not* acceptable.

**Figure 4-17** The *Range Checker* application's form



The following code sample shows the `checkButton_Click` event handler. Line 7 declares an `int` variable named `number`, initialized with the value that has been entered into the `inputTextBox` control. The `if` statement that begins in line 10 determines whether `number` is greater than or equal to 1 *AND* `number` is less than or equal to 10. If the Boolean expression is true, the statement in line 12 executes. Otherwise, the statement in line 16 executes.

```
1 private void checkButton_Click(object sender, EventArgs e)
2 {
3     try
4     {
5         // Declare a variable and initialize it with
6         // the user's input.
```

```

7         int number = int.Parse(inputTextBox.Text);
8
9         // Check the number's range.
10        if (number >= 1 && number <= 10)
11        {
12            MessageBox.Show("That number is acceptable.");
13        }
14        else
15        {
16            MessageBox.Show("That number is NOT acceptable.");
17        }
18    }
19    catch (Exception ex)
20    {
21        // Display an error message.
22        MessageBox.Show(ex.Message);
23    }
24 }

```



## Checkpoint

- 4.12 What is a compound Boolean expression?
- 4.13 The following truth table shows various combinations of the values `true` and `false` connected by a logical operator. Complete the table by circling T or F to indicate whether the result of such a combination is true or false.

Logical Expression	Result (circle T or F)	
<code>true &amp;&amp; false</code>	T	F
<code>true &amp;&amp; true</code>	T	F
<code>false &amp;&amp; true</code>	T	F
<code>false &amp;&amp; false</code>	T	F
<code>true    false</code>	T	F
<code>true    true</code>	T	F
<code>false    true</code>	T	F
<code>false    false</code>	T	F
<code>! true</code>	T	F
<code>! false</code>	T	F

- 4.14 Assume the variables `a = 2`, `b = 4`, and `c = 6`. Circle T or F for each of the following conditions to indicate if it is true or false.

<code>a == 4    b &gt; 2</code>	T	F
<code>6 &lt;= c &amp;&amp; a &gt; 3</code>	T	F
<code>1 != b &amp;&amp; c != 3</code>	T	F
<code>a &gt;= -1    a &lt;= b</code>	T	F
<code>!(a &gt; 2)</code>	T	F

- 4.15 Explain how short-circuit evaluation works with the `&&` and `||` operators.
- 4.16 Write an `if` statement that displays the message “The number is valid” in a message box if the variable `speed` is within the range 0 through 200.
- 4.17 Write an `if` statement that displays the message “The number is not valid” in a message box if the variable `speed` is outside the range 0 through 200.

## 4.5 bool Variables and Flags

**CONCEPT:** You can store the values `true` and `false` in `bool` variables, which are commonly used as flags.

The C# language provides the `bool` data type that you can use to create variables that hold `true` or `false` values. Here is an example of the declaration of a `bool` variable:

```
bool grandMaster;
```

This declares a `bool` variable named `grandMaster`. In the program we can assign the values `true` or `false` to the variable, as shown here:

```
if (points > 5000)
{
    grandMaster = true;
}
else
{
    grandMaster = false;
}
```

Variables of the `bool` data type are commonly used as flags. A **flag** is a variable that signals when some condition exists in the program. When the flag variable is set to `false`, it indicates that the condition does not yet exist. When the flag variable is set to `true`, it means the condition does exist. For example, the previous code might be used in a game to determine whether the user is a “grand master.” If he or she has earned more than 5,000 points, we set the `grandMaster` variable to `true`. Otherwise, we set the variable to `false`. Later in the program we can test the `grandMaster` variable, like this:

```
if (grandMaster)
{
    powerLevel += 500;
}
```

This code performs the following: if `grandMaster` is `true`, add 500 to `powerLevel`. Here is another example:

```
if (!grandMaster)
{
    powerLevel = 100;
}
```

This code performs the following: if `grandMaster` is not `true`, set `powerLevel` to 100.



### Checkpoint

- 4.18 What special values can you store in a `bool` variable?
- 4.19 What is a flag variable?

## 4.6 Comparing Strings

**CONCEPT:** You can use certain relational operators and methods to compare strings.

You can use the `==` operator to compare two strings. For example, look at the following code sample:

```
string name1 = "Mary";
string name2 = "Mark";

if (name1 == name2)
{
    MessageBox.Show("The names are the same.");
}
else
{
    MessageBox.Show("The names are NOT the same.");
}
```

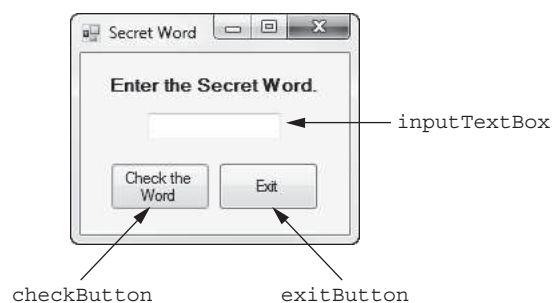
The `==` operator compares `name1` and `name2` to determine whether they are equal. Because the strings “Mary” and “Mark” are not equal, the `else` clause displays the message “The names are NOT the same.”

You can compare `string` variables with string literals as well. Assume `month` is a `string` variable. The following code sample uses the `!=` operator to determine whether `month` is not equal to “October”.

```
if (month != "October")
{
    statement;
}
```

Look at the *Secret Word* application in the *Chap04* folder of this book’s Student Sample Programs. Figure 4-18 shows the application’s form, with the names of some of the controls. The form prompts you to enter the secret word into the `inputTextBox` control. When you click the `checkButton` control, the application compares the string that you entered to “Ariel.”

**Figure 4-18** The *Secret Word* application’s form



The following code sample shows the `checkButton_Click` event handler. Line 5 declares a `string` variable named `secretWord`, initialized with the value that has been entered into the `inputTextBox` control. The `if` statement that begins in line 8 compares the `secretWord` variable to the string literal “Ariel”. If the two are equal, the statement in line 10 executes. Otherwise, the statement in line 14 executes.

```
1 private void checkButton_Click(object sender, EventArgs e)
2 {
3     // Declare a string variable and initialize it with
4     // the user's input.
5     string secretWord = inputTextBox.Text;
6
7     // Did the user enter the correct secret word?
8     if (secretWord == "Ariel")
```

```

 9      {
10      }
11      }
12      else
13      {
14      }
15      }
16      }

```

## Other String Comparisons

In addition to determining whether strings are equal or not equal, you can use the `String.Compare` method to determine whether one string is greater than or less than another string. This is a useful capability because sometimes you need to sort strings in some order. Before we look at how the method works, we should review how characters are stored in memory.

Recall from Chapter 1 that computers do not actually store characters, such as *A*, *B*, *C*, and so on, in memory. Instead, they store numeric codes that represent the characters. We mentioned in Chapter 1 that C# uses Unicode to represent characters. Here are some facts about the Unicode system:

- The uppercase characters *A* through *Z* are represented by the numbers 65 through 90.
- The lowercase characters *a* through *z* are represented by the numbers 97 through 122.
- When the digits 0 through 9 are stored in memory as characters, they are represented by the numeric codes 48 through 57. (For example, the string “abc123” is stored in memory as the codes 97, 98, 99, 49, 50, and 51.)
- A blank space is represented by the number 32.

In addition to establishing a set of numeric codes to represent characters in memory, Unicode also establishes an order for characters. The character *A* comes before the character *B*, which comes before the character *C*, and so on.

When a program compares characters, it actually compares the codes for the characters. The character *A* would be considered less than the character *B* because the character *A*'s numeric code is less than the character *B*'s numeric code.

Let's look at how strings containing more than one character are compared. Suppose we have the strings “Mary” and “Mark” stored in memory, as follows:

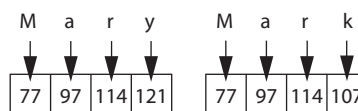
```

string name1 = "Mary";
string name2 = "Mark";

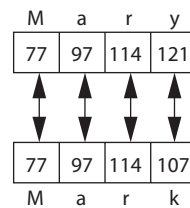
```

Figure 4-19 shows how the strings “Mary” and “Mark” are stored in memory using character codes.

**Figure 4-19** Character codes for the strings “Mary” and “Mark”



When you compare these strings in a program, they are compared character-by-character, beginning with the first, or leftmost, characters. This is shown in Figure 4-20.

**Figure 4-20** Comparing each character in a string

Here is how the comparison takes place:

1. The *M* in “Mary” is compared with the *M* in “Mark.” These are the same, so the next characters are compared.
2. The *a* in “Mary” is compared with the *a* in “Mark.” Because these are the same, the next characters are compared.
3. The *r* in “Mary” is compared with the *r* in “Mark.” These are the same, so the next characters are compared.
4. The *y* in “Mary” is compared with the *k* in “Mark.” Because these are not the same, the two strings are not equal. The character *y* has a higher character code (121) than *k* (107), so it is determined that the string “Mary” is greater than the string “Mark.”

If one of the strings in a comparison is shorter than the other, only the corresponding characters are compared. If the corresponding characters are identical, then the shorter string is considered less than the longer string. For example, suppose the strings “High” and “Hi” are compared. The string “Hi” is considered less than “High” because it is shorter.

In C# you cannot use relational operators to determine whether one string is greater than or less than another string. Instead, you use the `String.Compare` method. You use the following general format to call the method:

```
String.Compare(string1, string2)
```

In the general format, *string1* and *string2* are the strings that are being compared. The method returns an integer value indicating the result of the comparison. The integer value will be one of the following:

- Greater than zero if *string1* is greater than *string2*.
- Zero if *string1* is equal to *string2*.
- Less than zero if *string1* is less than *string2*.

Here is a code sample that uses the method to display two names in alphabetical order:

```
1 string str1 = "Joe";
2 string str2 = "Kerry";
3
4 if (String.Compare(str1, str2) < 0)
5 {
6     MessageBox.Show(str1 + " " + str2);
7 }
8 else
9 {
10    MessageBox.Show(str2 + " " + str1);
11 }
```

The `if` statement in line 4 calls the `String.Compare` method, passing `str1` and `str2` as arguments. If we execute this code, the method will return a value that is less than 0 because the string “Joe” is less than the string “Kerry”. As a result, the statement in line 6 will display *Joe Kerry*.

The `String.Compare` method performs a case sensitive comparison, which means that uppercase characters are not considered the same as their lowercase counterparts. For



example, the strings “Joe” and “joe” are not equal because the case of the first character is different in each. You can pass the Boolean value `true` as an optional third argument to the `String.Compare` method if you want it to perform a case insensitive comparison. Here is an example:

```

1 string str1 = "JOE";
2 string str2 = "joe";
3
4 if (String.Compare(str1, str2, true) == 0)
5 {
6     MessageBox.Show(str1 + " and " + str2 + " are equal.");
7 }
8 else
9 {
10    MessageBox.Show(str1 + " and " + str2 + " are NOT equal.");
11 }

```

Notice that the `if` statement in line 4 passes `true` as the third argument to the `String.Compare` method. This specifies that we want a case insensitive comparison. As a result, the method will return 0 and the statement in line 6 will display *JOE and joe are equal*.



## Checkpoint

4.20 If the following code were part of a complete program, what would it display?

```

if (String.Compare("z", "a") < 0)
{
    MessageBox.Show("z is less than a.");
}
else
{
    MessageBox.Show("z is not less than a.");
}

```

4.21 If the following code were part of a complete program, what would it display?

```

string s1 = "New York";
string s2 = "Boston";
if (String.Compare(s1, s2) > 0)
{
    MessageBox.Show(s2);
    MessageBox.Show(s1);
}
else
{
    MessageBox.Show(s1);
    MessageBox.Show(s2);
}

```

## 4.7

## Preventing Data Conversion Exceptions with the TryParse Methods

**CONCEPT:** Exceptions should be prevented when possible. You can use the `TryParse` methods to prevent exceptions as a result of the user entering invalid data.

In Chapter 3 you learned that the `Parse` methods throw an exception when you try to use them to convert nonnumeric data to a numeric data type. If you use one of the `Parse` methods to convert a `TextBox` control's `Text` property to a number, there is always the possibility of an exception being thrown. After all, the user is free to enter anything he or she wants into a `TextBox` control. To handle the exceptions that are caused by the `Parse` methods, we have been using the `try-catch` statement.

Although many exceptions happen for reasons that the programmer cannot anticipate (such as a system malfunction), some exceptions are predictable. For example, you know that using a `Parse` method to convert nonnumeric input to a numeric data type will throw an exception. In situations like that, where an exception is predictable, you should write your code to prevent the exception. It is a better programming practice to prevent an exception instead of allowing it to happen and then letting a `try-catch` statement react to it. You should use `try-catch` statements primarily for those exceptions that are beyond your control.



**NOTE:** Until now, we've simply been allowing exceptions to happen and letting a `try-catch` statement respond to them. After reading the previous paragraph, you might be wondering why we haven't been preventing exceptions all along. The reason is that you need to know how to write `if` statements to perform the techniques that we discuss in this section. Now that you know how to write `if` statements, you can add more sophistication to your code.

Now that you know how to write `if` statements, you can use a family of methods in the .NET Framework known as the `TryParse` methods. With the **TryParse methods**, you can determine whether a string (such as a control's `Text` property) contains a value that can be converted to a specific data type *before* it is converted to that data type. The `TryParse` methods do not throw an exception, so you can use them without a `try-catch` statement.

There are several `TryParse` methods in the .NET Framework. For now, we are using the `int`, `double`, and `decimal` numeric data types, so we will discuss three of them:

- We use the **`int.TryParse`** method to convert a string to an `int`.
- We use the **`double.TryParse`** method to convert a string to a `double`.
- We use the **`decimal.TryParse`** method to convert a string to a `decimal`.

When you call one of the `TryParse` methods, you pass two arguments: (1) the string that you want to convert, and (2) the name of the variable in which you want to store the converted value. First, let's look at the `int.TryParse` method. Here is the general format of how the `int.TryParse` method is called:

```
int.TryParse(string, out targetVariable)
```

In the general format, *string* is the string that you want to convert, and *targetVariable* is the name of an `int` variable. The method tries to convert the *string* argument to an `int`. If the conversion is successful, the converted value is stored in the *targetVariable*, and the method returns the Boolean value `true` to indicate that the conversion was successful. If the conversion is not successful, the method does not throw an exception. Instead, it stores 0 in the *targetVariable* and returns the Boolean value `false` to indicate that the *string* could not be converted.

Look carefully at the general format and notice that the word `out` appears before the *targetVariable*. The **`out`** keyword is required, and it specifies that the *targetVariable* is an output variable. An **output variable** is a variable that is passed as an argument to a method, and when the method is finished, a value is stored in the variable.

Because the `TryParse` methods return either `true` or `false`, they are commonly called as the Boolean expression in an `if` statement. The following code shows an example using

the `int.TryParse` method. In the example, assume that `inputTextBox` is the name of a `TextBox` control.

```

1 int number;
2
3 if (int.TryParse(inputTextBox.Text, out number))
4 {
5     MessageBox.Show("Success!");
6 }
7 else
8 {
9     MessageBox.Show("Enter a valid integer.");
10 }
```

The purpose of this code sample is to convert the value of the `inputTextBox` control's `Text` property to an `int` and assign that value to the `number` variable. In line 3, the `if` statement calls the `int.TryParse` method, passing `inputTextBox.Text` as argument 1 and `number` as argument 2. Here's what happens:

- If `inputTextBox.Text` is successfully converted to an `int`, the resulting value is assigned to the `number` variable, and the method returns `true`. That causes the statement in line 5 to execute.
- If `inputTextBox.Text` cannot be converted to an `int`, the value 0 is assigned to the `number` variable, and the method returns `false`. That causes the statement in line 9 (after the `else` clause) to execute.

The other `TryParse` methods work in a similar manner. Here is the general format of how the `double.TryParse` method is called:

```
double.TryParse(string, out targetVariable)
```

In the general format, `string` is the string that you want to convert, and `targetVariable` is the name of a `double` variable. If the `string` can be converted to a `double`, its value is stored in the `targetVariable`, and the method returns the Boolean value `true` to indicate that the conversion was successful. If the conversion was not successful, the method stores 0 in the `targetVariable` and returns the Boolean value `false` to indicate that the `string` could not be converted.

The following code shows an example using the `double.TryParse` method. In the example, assume that `inputTextBox` is the name of a `TextBox` control.

```

1 double number;
2
3 if (double.TryParse(inputTextBox.Text, out number))
4 {
5     MessageBox.Show("Success!");
6 }
7 else
8 {
9     MessageBox.Show("Enter a valid double.");
10 }
```

Here is the general format of how the `decimal.TryParse` method is called:

```
decimal.TryParse(string, out targetVariable)
```

In the general format, `string` is the string that you want to convert, and `targetVariable` is the name of a `decimal` variable. If the `string` can be converted to a `decimal`, its value is stored in the `targetVariable`, and the method returns the Boolean value `true` to indicate that the conversion was successful. If the conversion was not successful, the method stores 0 in the `targetVariable` and returns the Boolean value `false` to indicate that the `string` could not be converted.

The following code shows an example using the `decimal.TryParse` method. In the example, assume that `inputTextBox` is the name of a `TextBox` control.

```

1 decimal number;
2
3 if (decimal.TryParse(inputTextBox.Text, out number))
4 {
5     MessageBox.Show("Success!");
6 }
7 else
8 {
9     MessageBox.Show("Enter a valid decimal.");
10 }

```

## Validating the Data in Multiple TextBoxes

If a form has multiple `TextBox`s, then the user has multiple opportunities to enter an invalid piece of data. A well-designed program should validate the contents of each `TextBox` individually. When a piece of invalid data is found, the program should display an error message that tells the user specifically which `TextBox` contains the bad input.

This technique requires a set of nested `if` statements. For example, suppose a form has two `TextBox`s. The following pseudocode shows the logic for validating each `TextBox`. (In the pseudocode, a set of dotted lines connects each `If` statement with its corresponding `Else` clause and its ending.)

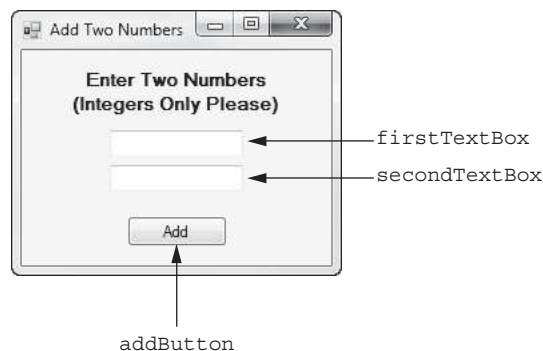
```

----- If the data in the first TextBox is good, then
----- If the data in the second TextBox is good, then
-----     Process the data in both TextBoxes
----- Else
-----     Display an error message about the second TextBox
----- End if
----- Else
-----     Display an error message about the first TextBox
----- End if

```

Let's see how that logic looks in actual C# code. In the *Chap04* folder of this book's Student Sample Programs, you will find a project named *Add Two Numbers*. The application's form is shown in Figure 4-21. When you run the application, enter an integer into each of the `TextBox` controls and then click the *Add* button. A message box will appear showing the sum of the two numbers. If you enter anything other than an integer into either `TextBox`, an error message will appear telling you which `TextBox` contains the invalid data.

**Figure 4-21** The *Add Two Numbers* form



Here is the code for the `addButton_Click` event handler:

```

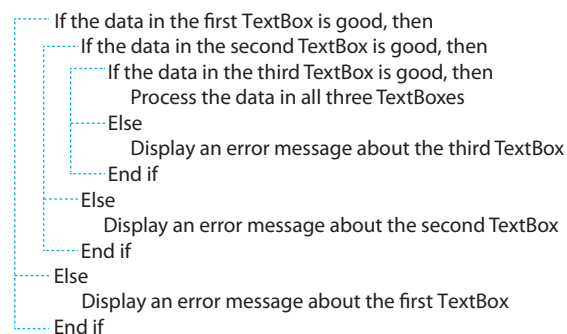
1 private void addButton_Click(object sender, EventArgs e)
2 {
3     // Local variables
4     int first, second, sum;
5
6     if (int.TryParse(firstTextBox.Text, out first))
7     {
8         if (int.TryParse(secondTextBox.Text, out second))
9         {
10            // Add the two numbers and display the sum.
11            sum = first + second;
12            MessageBox.Show(sum.ToString());
13        }
14        else
15        {
16            // Display an error message about the second TextBox.
17            MessageBox.Show("The second TextBox contains invalid data.");
18        }
19    }
20    else
21    {
22        // Display an error message about the first TextBox.
23        MessageBox.Show("The first TextBox contains invalid data.");
24    }
25 }

```

Let's take a closer look:

- Line 4 declares three `int` variables: `first`, `second`, and `sum`.
- The `if` statement in line 6 tries to convert `firstTextBox.Text` to an `int`. If the conversion is successful, the result is stored in the `first` variable, and the program continues executing at line 8. If the conversion is not successful, the program jumps to the `else` clause in line 20, and line 23 displays an error message regarding the first `TextBox` control.
- The `if` statement in line 8 tries to convert `secondTextBox.Text` to an `int`. If the conversion is successful, the result is stored in the `second` variable, and the program continues executing at line 10. If the conversion is not successful, the program jumps to the `else` clause in line 14, and line 17 displays an error message regarding the second `TextBox` control.
- The statements in lines 11 and 12 execute only if both `TextBox` controls contain valid integer values. These statements add the `first` and `second` variables and display their sum.

If you need to validate three `TextBox` controls, you will write a set of three nested `if` statements. Here's the pseudocode:



In Tutorial 4-4 you will complete an application that uses the `TryParse` methods to validate data entered into two `TextBox` controls.



VideoNote

**Tutorial 4-4:**  
Calculating  
Fuel  
Economy



## Tutorial 4-4: Calculating Fuel Economy

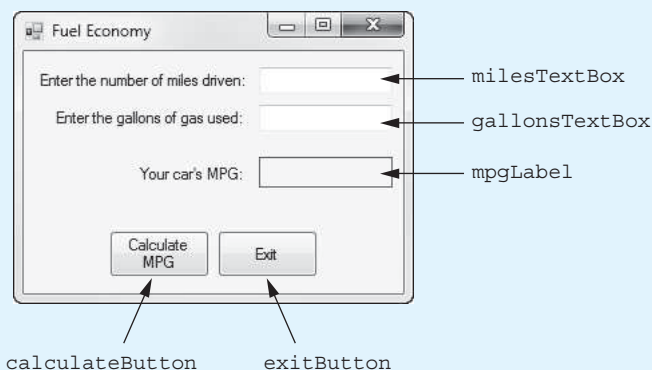
In Tutorial 3-2, you created an application that calculates a car's fuel economy in miles per gallon (MPG). Recall that the application lets the user enter the number of miles he or she has driven and the gallons of gas used. The application calculates and displays the car's MPG. In this tutorial you will create a new version of the application that validates the data entered by the user.

To save time, the project has already been started for you, and the application's form has already been created. To complete the project, follow the steps in this tutorial.

**Step 1:** Start Visual Studio (or Visual Studio Express). Open the project named *Fuel Economy with TryParse* in the *Chap04* folder of this book's Student Sample Programs.

**Step 2:** Open the `Form1` form in the *Designer*. The form is shown, along with the names of the important controls, in Figure 4-22.

**Figure 4-22** The *Fuel Economy* form



**Step 3:** Now you will create the Click event handlers for the Button controls. At the end of this tutorial, Program 4-4 shows the completed code for the form. You will be instructed to refer to Program 4-4 as you write the event handlers.

In the *Designer*, double-click the `calculateButton` control. This will open the code editor, and you see an empty event handler named `calculateButton_Click`. Complete the `calculateButton_Click` event handler by typing the code shown in lines 22–48 in Program 4-4.

Let's take a closer look at the code:

**Lines 22–24:** These lines declare the `double` variables `miles`, `gallons`, and `mpg`. The variables hold the miles driven, the gallons of gas used, and the MPG, respectively.

**Line 27:** This `if` statement tries to convert `milesTextBox.Text` to a `double`. If the conversion is successful, the result is stored in the `miles` variable, and the program continues executing at line 29. If the conversion is not successful, the program jumps to the `else` clause in line 44, and line 47 displays the error message "Invalid input for miles."

**Line 30:** This `if` statement tries to convert `gallonsTextBox.Text` to a double. If the conversion is successful, the result is stored in the `gallons` variable, and the program continues executing at line 32. If the conversion is not successful, the program jumps to the `else` clause in line 38, and line 41 displays the error message “Invalid input for gallons.”

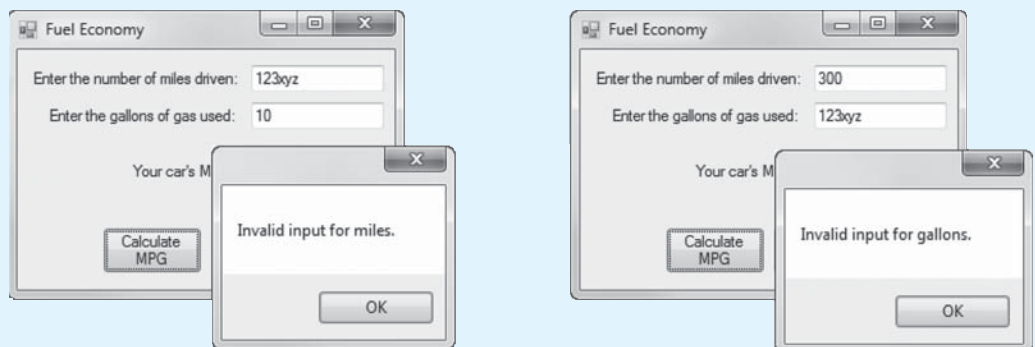
**Lines 32–36:** These lines are executed only if both the `milesTextBox` and `gallonsTextBox` contain valid data. Line 33 calculates MPG and assigns the result to the `mpg` variable, and line 36 displays the value of the `mpg` variable in the `mpgLabel` control.

**Step 4:** Switch your view back to the *Designer* and double-click the `exitButton` control. In the code editor you see an empty event handler named `exitButton_Click`. Complete the `exitButton_Click` event handler by typing the code shown in lines 53–54 in Program 4-4.

**Step 5:** Save the project and run the application. First, enter 300 for the miles and 10 for the gallons. Click the *Calculate MPG* button, and the application should display 30.0 as the MPG.

Now change the miles to an invalid entry, such as `123xyz`, and click the *Calculate MPG* button. The message “Invalid input for miles.” should appear in a message box, as shown on the left in Figure 4-23.

**Figure 4-23** Invalid input entered and the resulting error messages



Now change the miles back to 300, change the gallons to an invalid entry, such as `123xyz`, and click the *Calculate MPG* button. The message “Invalid input for gallons.” should appear in a message box, as shown on the right in Figure 4-23.

Continue to test the application as you wish. When you are finished, click the *Exit* button and the form should close.

**Program 4-4** Completed Form1 code for the *Fuel Economy with TryParse* application

```

1 using System;
2 using System.Collections.Generic;
3 using System.ComponentModel;
4 using System.Data;
5 using System.Drawing;
6 using System.Linq;
7 using System.Text;
8 using System.Threading.Tasks;
9 using System.Windows.Forms;
10
11 namespace Fuel_Economy_with_TryParse
12 {

```

```
13 public partial class Form1 : Form
14 {
15     public Form1()
16     {
17         InitializeComponent();
18     }
19
20     private void calculateButton_Click(object sender, EventArgs e)
21     {
22         double miles;    // To hold miles driven
23         double gallons;  // To hold gallons used
24         double mpg;     // To hold MPG
25
26         // Validate the milesTextBox control.
27         if (double.TryParse(milesTextBox.Text, out miles))
28         {
29             // Validate the gallonsTextBox control.
30             if (double.TryParse(gallonsTextBox.Text, out gallons))
31             {
32                 // Calculate MPG.
33                 mpg = miles / gallons;
34
35                 // Display the MPG in the mpgLabel control.
36                 mpgLabel.Text = mpg.ToString("n1");
37             }
38             else
39             {
40                 // Display an error message for gallonsTextBox.
41                 MessageBox.Show("Invalid input for gallons.");
42             }
43         }
44         else
45         {
46             // Display an error message for milesTextBox.
47             MessageBox.Show("Invalid input for miles.");
48         }
49     }
50
51     private void exitButton_Click(object sender, EventArgs e)
52     {
53         // Close the form.
54         this.Close();
55     }
56 }
57 }
```



## Checkpoint

- 4.22 What value does a TryParse method return if the string argument is successfully converted? What value does it return if the string is not converted?
- 4.23 If a TryParse method successfully converts the string argument, where is the result stored?
- 4.24 If a TryParse method cannot convert the string argument, what is stored in the second argument?
- 4.25 What does the keyword out mean when it is written before an argument to a method call?



## 4.8 Input Validation

**CONCEPT:** Input validation is the process of inspecting data that has been input to a program to make sure it is valid before it is used in a computation.

In the previous section you learned about using the `TryParse` methods to validate the type of data entered by the user. You should also validate the accuracy of the data that is entered by the user. One of the most famous sayings among computer programmers is “garbage in, garbage out.” This saying, sometimes abbreviated as *GIGO*, refers to the fact that computers cannot tell the difference between good input and bad input. If a user provides bad data as input to a program, the program will process that bad data and, as a result, will produce bad data as output.

For example, consider a payroll program that accepts the number of hours that an employee has worked in a given week as input. If the payroll clerk accidentally enters 400 hours instead of 40 hours, an unusually large check will be written because there are less than 400 hours in a week! The computer, however, is unaware of this fact, and unless the program is written to catch such errors, it will process the bad data just as if it were good data.

Sometimes stories are reported in the news about computer errors that mistakenly cause people to be charged thousands of dollars for small purchases or to receive large tax refunds to which they were not entitled. These “computer errors” are rarely caused by a computer, however; they are more commonly caused by software bugs or bad data that was read into a program as input.

The integrity of a program’s output is only as good as the integrity of its input. For this reason, you should write your programs in such a way that bad input is never accepted. When input is given to a program, it should be inspected before it is processed. If the input is invalid, the program should discard it and prompt the user to enter the correct data. This process is known as **input validation**.

For example, in a payroll program we might validate the number of hours worked like this:

```

1 if (int.TryParse(hoursWorkedTextBox.Text, out hours))
2 {
3     if (hours > 0 && hours <= 168)
4     {
5         // Continue to process the input.
6     }
7     else
8     {
9         MessageBox.Show("Invalid number of hours entered.");
10    }
11 }
12 else
13 {
14     MessageBox.Show("The hours worked must be an integer.");
15 }

```

Let’s assume the application uses a `TextBox` named `hoursWorkedTextBox` to get the hours worked. Also assume that the variable `hours` has already been declared as an `int`. The outer `if` statement (line 1) uses the `int.TryParse` method to make sure the user has entered an integer. If so, the value is stored in the `hours` variable and the program continues to the inner `if` statement (line 3). The inner `if` statement ensures that we process the input only if `hours` is greater than 0 *and* `hours` is less than or equal to 168. This is because we cannot write a paycheck for 0 hours worked, and 168 is the maximum number of hours in a week.

Let's look at another example. The following code comes from an application that gets a test score as input. A valid test score is an integer in the range of 0 through 100.

```

1 if (int.TryParse(testScoreTextBox.Text, out testScore))
2 {
3     if (testScore >= 0 && testScore <= 100)
4     {
5         // Continue to process the input.
6     }
7     else
8     {
9         MessageBox.Show("Test score must be in the range 0 - 100.");
10    }
11 }
12 else
13 {
14     MessageBox.Show("The test score must be an integer.");
15 }

```

Let's assume the application uses a `TextBox` named `testScoreTextBox` to get the test score. Also assume that the variable `testScore` has already been declared as an `int`. The outer `if` statement (line 1) uses the `int.TryParse` method to make sure the user has entered an integer. If so, the value is stored in the `testScore` variable and the program continues to the inner `if` statement (line 3). The inner `if` statement ensures that we process the input only if `testScore` is greater than or equal to 0 *and* `testScore` is less than or equal to 100.

## 4.9

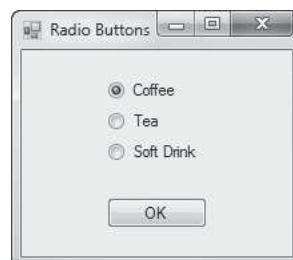
## Radio Buttons and Check Boxes

**CONCEPT:** GUIs commonly use radio buttons and check boxes to let the user select items.

### Radio Buttons

**Radio buttons** are useful when you want the user to select one choice from several possible choices. Figure 4-24 shows a form with a group of three radio buttons. The radio buttons in the figure allow the user to select *Coffee*, *Tea*, or *Soft Drink*.

**Figure 4-24** Radio buttons



A radio button may be either selected or deselected. Each radio button has a small circle that appears filled in when the radio button is selected, and appears empty when the radio button is deselected. In Figure 4-24, the *Coffee* radio button is selected and the other radio buttons are deselected.

At run time, only one radio button in a group may be selected at a time. Clicking on a radio button selects it, and automatically deselects any other radio button in the same group. We call this **mutually exclusive selection**.



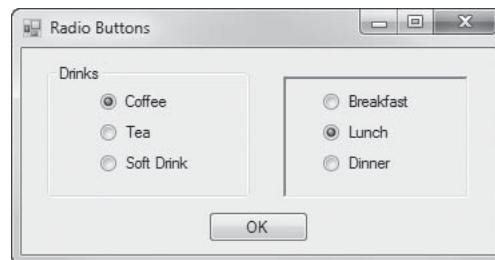
**NOTE:** The name *radio button* refers to the old car radios that had push buttons for selecting stations. Only one button could be pushed in at a time. When you pushed a button, it automatically popped out the currently selected button.

When you want to create a group of radio buttons on a form, you use the **RadioButton control**, which is found in the *Common Controls* section of the *Toolbox*. RadioButton controls are normally grouped in one of the following ways:

- You place them inside a GroupBox control. All RadioButton controls that are inside a GroupBox are members of the same group.
- You place them inside a Panel control. All RadioButton controls that are inside a Panel are members of the same group.
- You place them on a form but not inside a GroupBox or a Panel. All RadioButton controls that are on a form but not inside a GroupBox or Panel are members of the same group.

Figure 4-25 shows a form with two groups of RadioButton controls. The group on the left is inside a GroupBox control, and the group on the right is inside a Panel control. When the application runs, the user will be able to select only one RadioButton from each group. In the figure, *Coffee* is selected in the left group and *Lunch* is selected in the right group.

**Figure 4-25** A form with two groups of RadioButton controls



### The RadioButton Control's Text Property

RadioButton controls have a **Text** property, which holds the text that is displayed next to the radio button's circle. For example, the radio buttons shown in Figure 4-24 have their Text properties set to *Coffee*, *Tea*, and *Soft Drink*.

### The RadioButton Control's Checked Property

RadioButton controls have a **Checked** property that determines whether the control is selected or deselected. The Checked property is a Boolean property, which means that it may be set to either True or False. When the Checked property is set to True, the RadioButton is selected, and when the Checked property is set to False, the RadioButton is deselected. By default, the Checked property is set to False.

You can use the *Properties* window to set the initial value of a RadioButton control's Checked property. Keep in mind that the Checked property of only one RadioButton in a group can be set to True at a given time. When you set a RadioButton control's Checked property to True in the *Properties* window, the Checked properties of all the other RadioButtons in the same group automatically are set to False.



**TIP:** When you create a group of `RadioButton` controls, you should always set one of the control's `Checked` property to `True` in the *Properties* window. If all the `RadioButtons` in a group have their `Checked` property set to `False`, then the `Checked` property of the `RadioButton` with the lowest `TabIndex` value will automatically be set to `True` when you run the application.

### Working with Radio Buttons in Code

In code, you can determine whether a `RadioButton` control is selected by testing its `Checked` property. For example, suppose a form has a `RadioButton` control named `choice1RadioButton`. The following `if` statement determines whether it is selected:

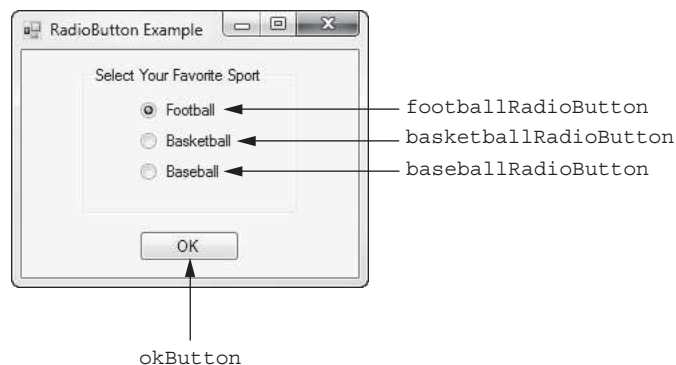
```
if (choice1RadioButton.Checked)
{
    MessageBox.Show("You selected Choice 1");
}
```

Notice that we did not have to use the `==` operator to explicitly compare the `Checked` property to the value `true`. This code is equivalent to the following:

```
if (choice1RadioButton.Checked == true)
{
    MessageBox.Show("You selected Choice 1.");
}
```

Let's look at an example using multiple `RadioButton` controls. Open the *RadioButton* project in the *Chap04* folder of this book's Student Sample Programs. The application's form is shown in Figure 4-26. When you run the application, select one of the radio buttons and then click the *OK* button. A message box appears showing the sport that you selected.

**Figure 4-26** The *RadioButton Example* form



Here is the code for the `okButton_Click` event handler:

```
1 private void okButton_Click(object sender, EventArgs e)
2 {
3     if (footballRadioButton.Checked)
4     {
5         MessageBox.Show("You selected Football.");
6     }
7     else if (basketballRadioButton.Checked)
8     {
9         MessageBox.Show("You selected Basketball.");
10    }
11    else if (baseballRadioButton.Checked)
```

```

12     {
13         MessageBox.Show("You selected Baseball.");
14     }
15 }

```

When the event handler executes, the `if` statement in line 3 determines whether the `footballRadioButton` control's `Checked` property is true. If it is, the message *You selected Football.* is displayed in line 5. Otherwise, line 7 determines whether the `basketballRadioButton` control's `Checked` property is true. If it is, the message *You selected Basketball.* is displayed in line 9. Otherwise, line 11 determines whether the `baseballRadioButton` control's `Checked` property is true. If it is, the message *You selected Baseball.* is displayed in line 13.

## Check Boxes

A **check box** appears as a small box with some accompanying text. Figure 4-27 shows an example. They are called check boxes because clicking on an empty check box causes a check mark to appear in it. If a check mark already appears in a check box, clicking it removes the check mark.

**Figure 4-27** A check box



Check boxes are similar to radio buttons, except that check boxes are not mutually exclusive. You can have one or more check boxes in a group, and any number of them can be selected at any given time. When you want to create a check box on a form, you use the `CheckBox` control, which is found in the *Common Controls* section of the *Toolbox*.

### The CheckBox Control's Text Property

`CheckBox` controls have a `Text` property, which holds the text that is displayed next to the check box. For example, the `CheckBox` control shown in Figure 4-27 has its `Text` property set to *Pepperoni*.

### The CheckBox Control's Checked Property

Like radio buttons, `CheckBox` controls have a `Checked` property. When a `CheckBox` control is selected, or checked, its `Checked` property is set to `True`. When a `CheckBox` control is deselected, or unchecked, its `Checked` property is set to `False`.

### Working with CheckBox Controls in Code

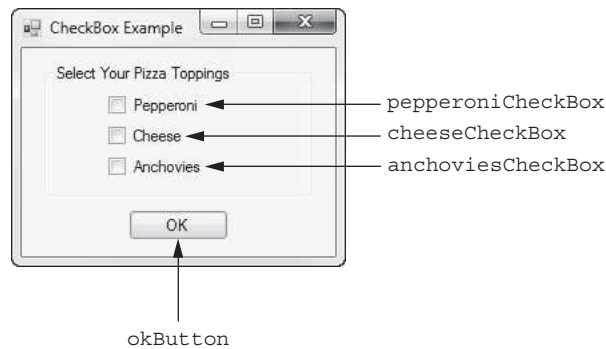
In code, you can determine whether a `CheckBox` control is selected by testing its `Checked` property. For example, suppose a form has a `CheckBox` control named `option1CheckBox`. The following `if` statement determines whether it is selected:

```

if (option1CheckBox.Checked)
{
    MessageBox.Show("You selected Option 1.");
}

```

Let's look at an example program. Open the *CheckBox Example* project in the *Chap04* folder of this book's Student Sample Programs. The application's form is shown in Figure 4-28. When you run the application, select any of the check boxes and then click the *OK* button. One or more message boxes will appear, showing you the items that you selected.

**Figure 4-28** The *CheckBox Example* form

Here is the code for the `okButton_Click` event handler:

```

1 private void okButton_Click(object sender, EventArgs e)
2 {
3     if (pepperoniCheckBox.Checked)
4     {
5         MessageBox.Show("You selected Pepperoni.");
6     }
7
8     if (cheeseCheckBox.Checked)
9     {
10        MessageBox.Show("You selected Cheese.");
11    }
12
13    if (anchoviesCheckBox.Checked)
14    {
15        MessageBox.Show("You selected Anchovies.");
16    }
17 }

```

Notice that we have three separate `if` statements. The `if` statement in line 3 determines whether the `pepperoniCheckBox` control is selected. If so, line 5 displays the message *You selected Pepperoni*. The `if` statement in line 8 determines whether the `cheeseCheckBox` control is selected. If so, line 10 displays the message *You selected Cheese*. The `if` statement in line 13 determines whether the `anchoviesCheckBox` control is selected. If so, line 15 displays the message *You selected Anchovies*.

## The CheckedChanged Event

Any time a `RadioButton` or a `CheckBox` control's `Checked` property changes, a **CheckedChanged** event happens for that control. If you want some action to immediately take place when the user selects (or deselects) a `RadioButton` or `CheckBox` control, you can create a `CheckedChanged` event handler for the control and write the desired code in that event handler.

To create a `CheckedChanged` event handler for a `RadioButton` or a `CheckBox`, simply double-click the control in the *Designer*. An empty `CheckedChanged` event handler is created in the code editor. You can then write code inside the event handler. Tutorial 4-5 leads you through the process.



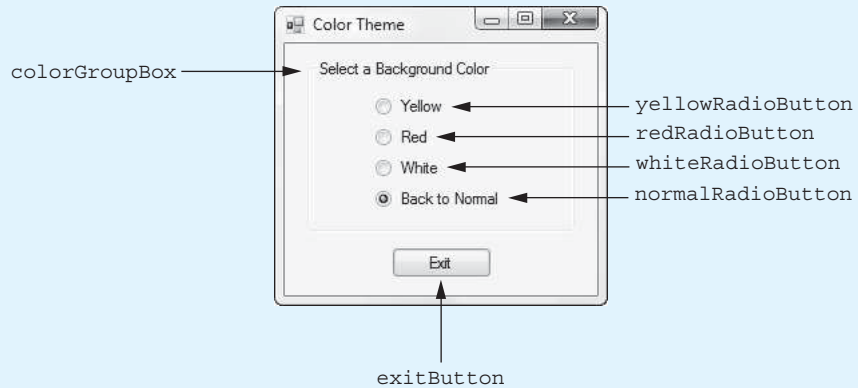
**Tutorial 4-5:**  
Creating the *Color Theme* application



### Tutorial 4-5: Creating the *Color Theme* Application

In this tutorial you create an application that allows the user to select a color using `RadioButton` controls. When the user selects a color, the form's background color is changed to that color immediately. Figure 4-29 shows the application's form, with the names of all the controls.

**Figure 4-29** The *Color Theme* form



- Step 1:** Start Visual Studio (or Visual Studio Express) and begin a new Windows Forms Application project named *Color Theme*.
- Step 2:** Set up the application's form as shown in Figure 4-29. Notice that the form's `Text` property is set to *Color Theme*. The names of the controls are shown in the figure. As you place each of the controls on the form, refer to Table 4-8 for the relevant property settings.

**Table 4-8** Control property settings

Control Name	Control Type	Property Settings
colorGroupBox	GroupBox	<b>Text:</b> <i>Select a Background Color</i>
yellowRadioButton	RadioButton	<b>Text:</b> <i>Yellow</i> <b>Checked:</b> False
redRadioButton	RadioButton	<b>Text:</b> <i>Red</i> <b>Checked:</b> False
whiteRadioButton	RadioButton	<b>Text:</b> <i>White</i> <b>Checked:</b> False
normalRadioButton	RadioButton	<b>Text:</b> <i>Back to Normal</i> <b>Checked:</b> True
exitButton	Button	<b>Text:</b> <i>Exit</i>

- Step 3:** Once you have set up the form with its controls, you can create the `CheckedChanged` event handlers for the `RadioButton` controls. At the end of this tutorial, Program 4-5 shows the completed code for the form. You will be instructed to refer to Program 4-5 as you write the event handlers.

In the *Designer*, double-click the `yellowRadioButton` control. This opens the code editor, and you see an empty event handler named `yellowRadioButton_CheckedChanged`. Complete the `yellowRadioButton_CheckedChanged` event handler by typing the code shown in lines 22–25 in Program 4-5.

The event handler is easy to understand. The `if` statement in line 22 determines whether the `yellowRadioButton` control is checked. If so, line 24 sets the form's background to yellow.

- Step 4:** Switch your view back to the *Designer* and double-click the `redRadioButton` control. This opens the code editor, and you see an empty event handler named `redRadioButton_CheckedChanged`. Complete the `redRadioButton_CheckedChanged` event handler by typing the code shown in lines 30–33 in Program 4-5.
- Step 5:** Switch your view back to the *Designer* and double-click the `whiteRadioButton` control. This opens the code editor, and you see an empty event handler named `whiteRadioButton_CheckedChanged`. Complete the `whiteRadioButton_CheckedChanged` event handler by typing the code shown in lines 38–41 in Program 4-5.
- Step 6:** Switch your view back to the *Designer* and double-click the `normalRadioButton` control. This opens the code editor, and you see an empty event handler named `normalRadioButton_CheckedChanged`. Complete the `normalRadioButton_CheckedChanged` event handler by typing the code shown in lines 46–49 in Program 4-5.
- Step 7:** Switch your view back to the *Designer* and double-click the `exitButton` control. In the code editor you see an empty event handler named `exitButton_Click`. Complete the `exitButton_Click` event handler by typing the code shown in lines 54–55 in Program 4-5.
- Step 8:** Save the project and run the application. Notice that the *Back to Normal* radio button is initially selected. That's because you set its `Checked` property to `True` in the Properties window. Click the other *Radio* buttons and notice that the form's background color changes immediately. When you are finished testing the application, click the *Exit* button to close it.

---

#### Program 4-5 Completed Form1 code for the *Color Theme* application

```
1 using System;
2 using System.Collections.Generic;
3 using System.ComponentModel;
4 using System.Data;
5 using System.Drawing;
6 using System.Linq;
7 using System.Text;
8 using System.Threading.Tasks;
9 using System.Windows.Forms;
10
11 namespace Color_Theme
12 {
13     public partial class Form1 : Form
14     {
15         public Form1()
16         {
17             InitializeComponent();
18         }
19
20         private void yellowRadioButton_CheckedChanged(object sender, EventArgs e)
21         {
22             if (yellowRadioButton.Checked)
```



```

23         {
24             this.BackColor = Color.Yellow;
25         }
26     }
27
28     private void redRadioButton_CheckedChanged(object sender, EventArgs e)
29     {
30         if (redRadioButton.Checked)
31         {
32             this.BackColor = Color.Red;
33         }
34     }
35
36     private void whiteRadioButton_CheckedChanged(object sender, EventArgs e)
37     {
38         if (whiteRadioButton.Checked)
39         {
40             this.BackColor = Color.White;
41         }
42     }
43
44     private void normalRadioButton_CheckedChanged(object sender, EventArgs e)
45     {
46         if (normalRadioButton.Checked)
47         {
48             this.BackColor = SystemColors.Control;
49         }
50     }
51
52     private void exitButton_Click(object sender, EventArgs e)
53     {
54         // Close the form.
55         this.Close();
56     }
57 }
58 }

```



## Checkpoint

- 4.26 If several RadioButton controls have been created in the same GroupBox, how many of them may be selected at one time?
- 4.27 If several CheckBox controls have been created in the same GroupBox, how many of them may be selected at one time?
- 4.28 In code, how do you determine whether a RadioButton or a CheckBox control has been selected?

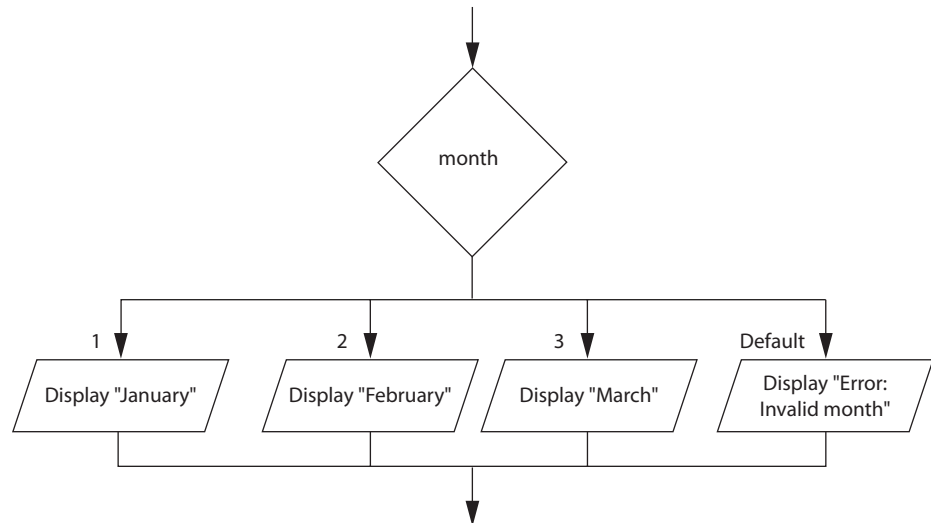
## 4.10 The switch Statement

**CONCEPT:** The **switch** statement lets the value of a variable or an expression determine which path of execution the program will take.

The **switch** statement is a **multiple-alternative decision structure**. It allows you to test the value of a variable or an expression and then use that value to determine which statement

or set of statements to execute. Figure 4-30 shows an example of how a multiple alternative decision structure looks in a flowchart.

**Figure 4-30** A multiple alternative decision structure



In the flowchart, the diamond symbol shows `month`, which is the name of a variable. If the `month` variable contains the value 1, the program displays “January.” If the `month` variable contains the value 2, the program displays “February.” If the `month` variable contains the value 3, the program displays “March.” If the `month` variable contains none of these values, the action that is labeled `Default` is executed. In this case, the program displays “Error: Invalid month.”

Here is the general format of a `switch` statement in C# code:

```

switch (testExpression)
{
    case value_1:
        statement;
        statement;
        etc.
        break;

    case value_2:
        statement;
        statement;
        etc.
        break;

    case value_N:
        statement;
        statement;
        etc.
        break;

    default:
        statement;
        statement;
        etc.
        break;
}

```

The *testExpression* is a variable or expression.

These statements are executed if the *testExpression* is equal to *value\_1*.

These statements are executed if the *testExpression* is equal to *value\_2*.

Insert as many case sections as necessary.

These statements are executed if the *testExpression* is equal to *value\_N*.

These statements are executed if the *testExpression* is not equal to any of the case values.

The first line of the statement starts with the word `switch`, followed by a *testExpression*, which is enclosed in parentheses. The *testExpression* is a variable or an expression that gives an integer, string, or `bool` value. (Several other data types that we have not discussed yet are also permissible. The important thing to remember is that the *testExpression* cannot be a floating-point or decimal value.)

Beginning at the next line is a block of code enclosed in curly braces. Inside this block of code are one or more `case` sections. A `case` section begins with the word `case`, followed by a value, followed by a colon. Each `case` section contains one or more statements, followed by a `break` statement. Each `case` section must end with a `break` statement. At the end is an optional `default` section. The `default` section must also end with a `break` statement.

When the `switch` statement executes, it compares the value of the *testExpression* with the values that follow each of the `case` statements (from top to bottom). When it finds a `case` value that matches the *testExpression*'s value, the program branches to the `case` statement. The statements that follow the `case` statement are executed, until a `break` statement is encountered. At that point the program jumps out of the `switch` statement. If the *testExpression* does not match any of the `case` values, the program branches to the `default` statement and executes the statements that immediately follow it.

For example, the following code performs the same operation as the flowchart in Figure 4-30:

```
switch (month)
{
    case 1:
        MessageBox.Show("January");
        break;

    case 2:
        MessageBox.Show("February");
        break;

    case 3:
        MessageBox.Show("March");
        break;

    default:
        MessageBox.Show("Error: Invalid month");
        break;
}
```

In this example the *testExpression* is the `month` variable. If the value in the `month` variable is 1, the program branches to the `case 1:` section and executes the `MessageBox.Show("January")` statement that immediately follows it. If the value in the `month` variable is 2, the program branches to the `case 2:` section and executes the `MessageBox.Show("February")` statement that immediately follows it. If the value in the `month` variable is 3, the program branches to the `case 3:` section and executes the `MessageBox.Show("March")` statement that immediately follows it. If the value in the `month` variable is not 1, 2, or 3, the program branches to the `default:` section and executes the `MessageBox.Show("Error: Invalid month")` statement that immediately follows it.

The `switch` statement can be used as an alternative to an `if-else-if` statement that tests the same variable or expression for several different values. For example, the previously shown `switch` statement works like this `if-else-if` statement:

```

if (month == 1)
{
    MessageBox.Show("January");
}
else if (month == 2)
{
    MessageBox.Show("February");
}
else if (month == 3)
{
    MessageBox.Show("March");
}
else
{
    MessageBox.Show("Error: Invalid month");
}

```

To see an application that uses a `switch` statement, look at the *Switch Example* project in the *Chap04* folder of this book's Student Sample Programs.



## Checkpoint

4.29 Convert the following `if-else-if` code to a `switch` statement.

```

if (choice == 1)
{
    MessageBox.Show("You chose 1.");
}
else if (choice == 2)
{
    MessageBox.Show("You chose 2.");
}
else if (choice == 3)
{
    MessageBox.Show("You chose 3.");
}
else
{
    MessageBox.Show("Make another choice.");
}

```

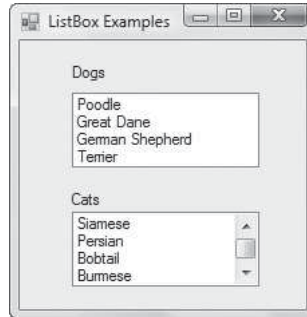
## 4.11

## Introduction to List Boxes

**CONCEPT:** List boxes display a list of items and allow the user to select an item from the list.

A list box displays a list of items and allows the user to select one or more items from the list. In Visual C# you use the **ListBox control** to create a list box on an application's form. Figure 4-31 shows a form with two `ListBox` controls. At run time, the user may select one of the items, causing the item to appear selected.

The topmost `ListBox` in Figure 4-31 does not have a scroll bar, but the bottom one does. A scroll bar appears when a `ListBox` contains more items than can be displayed in the

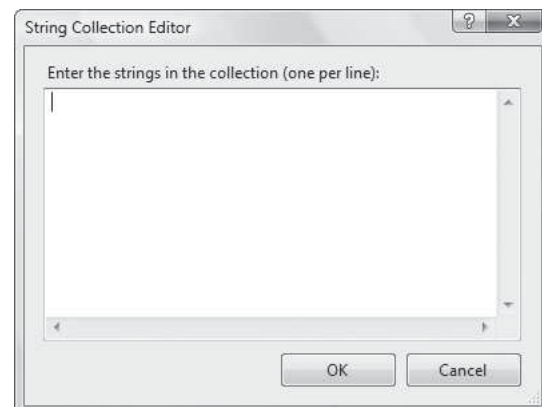
**Figure 4-31** ListBox examples

space provided. In the figure, the top ListBox has four items (Poodle, Great Dane, German Shepherd, and Terrier), and all items are displayed. The bottom ListBox shows four items (Siamese, Persian, Bobtail, and Burmese), but because it has a scroll bar, we know there are more items in the ListBox than those four.

You will find the ListBox control in the *Common Controls* section of the *Toolbox*. Once you create a ListBox control, you add items to its **Items property**. The items that you add to a ListBox's Items property are displayed in the ListBox.

To store values in the Items property at design time, follow these steps:

1. Select the ListBox control in the *Designer* window.
2. In the *Properties* window, the setting for the Items property is displayed as (*Collection*). When you select the Items property, an ellipsis button (⋮) appears.
3. Click the ellipsis button. The *String Collection Editor* dialog box appears, as shown in Figure 4-32.
4. Type the values that are to appear in the ListBox into the *String Collection Editor* dialog box. Type each value on a separate line by pressing the Enter key after each entry.
5. When you have entered all the values, click the *OK* button.

**Figure 4-32** The *String Collection Editor* dialog box

**NOTE:** Once you acquire the necessary skills, you will be able to fill the Items collection of list boxes from external data sources (such as databases).

## The SelectedItem Property

When the user selects an item in a ListBox, the item is stored in the ListBox's `SelectedItem` property. For example, suppose an application has a ListBox control named `fruitListBox` and a string variable named `selectedFruit`. The `fruitListBox` control contains the items *Apples*, *Pears*, and *Bananas*. If the user has selected *Pears*, the following statement assigns the string "Pears" to the variable `selectedFruit`:

```
selectedFruit = fruitListBox.SelectedItem.ToString();
```

Notice that you have to call the `SelectedItem` property's `ToString` method to retrieve the value as a string.

## Determining Whether an Item Is Selected

An exception will occur if you try to get the value of a ListBox's `SelectedItem` property when no item is selected in the ListBox. For that reason, you should always make sure that an item is selected before reading the `SelectedItem` property. You do this with the `SelectedIndex` property.

The items that are stored in a ListBox each have an index. The **index** is simply a number that identifies the item's position in the ListBox. The first item has the index 0, the next has the index 1, and so on. The last index value is  $n - 1$ , where  $n$  is the number of items in the ListBox. When the user selects an item in a ListBox, the item's index is stored in the ListBox's `SelectedIndex` property. If no item is selected in the ListBox, the `SelectedIndex` property is set to  $-1$ .

You can use the `SelectedIndex` property to make sure that an item is selected in a ListBox before you try to get the value of the `SelectedItem` property. You simply make sure the `SelectedIndex` property is not set to  $-1$  before trying to read the `SelectedItem` property. Here is an example:

```
if (fruitListBox.SelectedIndex != -1)
{
    selectedFruit = fruitListBox.SelectedItem.ToString();
}
```

In Tutorial 4-6 you will create an application that lets the user select an item from a ListBox control.



VideoNote

**Tutorial 4-6:**  
Creating the  
*Time Zone*  
application



### Tutorial 4-6:

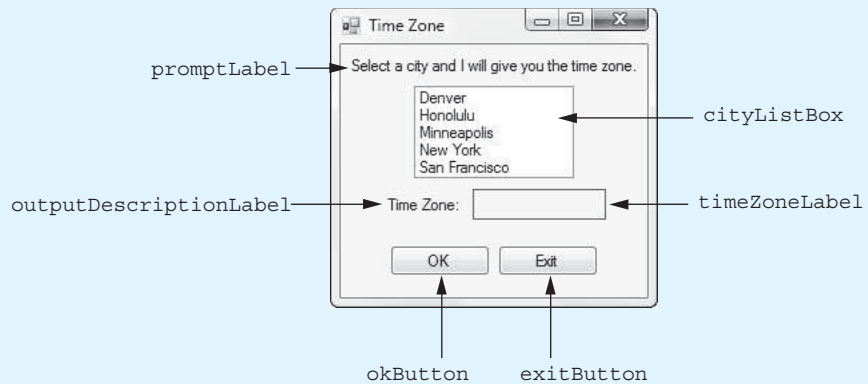
#### Creating the *Time Zone* Application

In this tutorial you create an application that allows the user to select a city from a List-Box control. When the user clicks a button, the application displays the name of the city's time zone. Figure 4-33 shows the application's form, with the names of all the controls.

**Step 1:** Start Visual Studio (or Visual Studio Express) and begin a new Windows Forms Application project named *Time Zone*.

**Step 2:** Set up the application's form, as shown in Figure 4-33. Notice that the form's Text property is set to *Time Zone*. The names of the controls are shown in the figure. As you place each of the controls on the form, refer to Table 4-9 for the relevant property settings.

**Figure 4-33** The *Color Theme* form



**Table 4-9** Control property settings

Control Name	Control Type	Property Settings
promptLabel	Label	<b>Text:</b> <i>Select a city and I will give you the time zone.</i>
cityListBox	ListBox	<b>Items:</b> <i>Denver</i> <i>Honolulu</i> <i>Minneapolis</i> <i>New York</i> <i>San Francisco</i>
outputDescriptionLabel	Label	<b>Text:</b> <i>Time Zone:</i>
timeZoneLabel	Label	<b>AutoSize:</b> False <b>BorderStyle:</b> FixedSingle <b>Text:</b> (The contents of the Text property have been erased.) <b>TextAlign:</b> MiddleCenter
okButton	Button	<b>Text:</b> <i>OK</i>
exitButton	Button	<b>Text:</b> <i>Exit</i>

**Step 3:** Once you have set up the form with its controls, you can create the Click event handlers for the Button controls. At the end of this tutorial, Program 4-6 shows the completed code for the form. You will be instructed to refer to Program 4-6 as you write the event handlers.

In the *Designer*, double-click the `okButton` control. This opens the code editor, and you see an empty event handler named `okButton_Click`. Complete the `okButton_Click` event handler by typing the code shown in lines 22–53 in Program 4-6. Let’s take a closer look at the code:

**Line 22:** This line declares a `string` variable named `city`. It is used to hold the name of the city that the user selects from the `ListBox`.

**Line 24:** This `if` statement determines whether the user has selected an item in the `cityListBox` control. If an item is selected, the control’s `SelectedIndex` property is set to the item’s index (a value of 0 or greater), and the program continues to line 26. If no item is selected, however, the control’s `SelectedIndex` property is set to `-1`, and the program jumps to the `else` clause in line 49.

**Line 27:** This statement gets the selected item from the `ListBox` and assigns it to the `city` variable.

**Line 30:** This `switch` statement tests the `city` variable and branches to one of its case statements, depending on the variable's value:

- If the `city` variable equals "Honolulu", the program jumps to the case statement in line 32.
- If the `city` variable equals "San Francisco", the program jumps to the case statement in line 35.
- If the `city` variable equals "Denver", the program jumps to the case statement in line 38.
- If the `city` variable equals "Minneapolis", the program jumps to the case statement in line 41.
- If the `city` variable equals "New York", the program jumps to the case statement in line 44.

**Step 4:** Switch your view back to the *Designer* and double-click the `exitButton` control. In the code editor you see an empty event handler named `exitButton_Click`. Complete the `exitButton_Click` event handler by typing the code shown in lines 58–59 in Program 4-6.

**Step 5:** Save the project and run the application. Select a city in the `ListBox` control and click the `OK` button to see its time zone. Test each city, and when you are finished, click the *Exit* button and the form should close.

---

#### Program 4-6 Completed Form1 code for the *Time Zone* application

```
1 using System;
2 using System.Collections.Generic;
3 using System.ComponentModel;
4 using System.Data;
5 using System.Drawing;
6 using System.Linq;
7 using System.Text;
8 using System.Threading.Tasks;
9 using System.Windows.Forms;
10
11 namespace Time_Zone
12 {
13     public partial class Form1 : Form
14     {
15         public Form1()
16         {
17             InitializeComponent();
18         }
19
20         private void okButton_Click(object sender, EventArgs e)
21         {
22             string city;    // To hold the name of a city
23
24             if (cityListBox.SelectedIndex != -1)
25             {
26                 // Get the selected item.
27                 city = cityListBox.SelectedItem.ToString();
28
29                 // Determine the time zone.
```



```

30         switch (city)
31         {
32             case "Honolulu":
33                 timeZoneLabel.Text = "Hawaii-Aleutian";
34                 break;
35             case "San Francisco":
36                 timeZoneLabel.Text = "Pacific";
37                 break;
38             case "Denver":
39                 timeZoneLabel.Text = "Mountain";
40                 break;
41             case "Minneapolis":
42                 timeZoneLabel.Text = "Central";
43                 break;
44             case "New York":
45                 timeZoneLabel.Text = "Eastern";
46                 break;
47         }
48     }
49     else
50     {
51         // No city was selected.
52         MessageBox.Show("Select a city.");
53     }
54 }
55
56 private void exitButton_Click(object sender, EventArgs e)
57 {
58     // Close the form.
59     this.Close();
60 }
61 }
62 }

```



## Checkpoint

- 4.30 How do you add items to a ListBox control using the *Properties* window?
- 4.31 How do you get the item that is selected in a ListBox?
- 4.32 How can you determine whether an item has been selected in a ListBox?

## Key Terms

! operator  
 && operator  
 || operator  
 bool data type  
 Boolean expression  
 check box  
 CheckBox control  
 Checked property  
 CheckChanged event  
 conditionally executed  
 control structure  
 decimal.TryParse method  
 decision structure  
 double.TryParse method  
 dual-alternative decision structure  
 flag  
 if-else statement  
 if-else-if statement  
 index  
 input validation  
 int.TryParse method  
 Items property  
 ListBox control  
 logical AND operator  
 logical NOT operator  
 logical operator  
 logical OR operator  
 multiple-alternative decision structure  
 mutually exclusive selection  
 nested decision structure  
 out keyword  
 output variable  
 radio buttons  
 RadioButton control  
 relational operator  
 SelectedIndex property  
 SelectedItem property  
 selection structure  
 sequence structure  
 short-circuit evaluation  
 single-alternative decision structure  
 switch statement  
 TryParse method

## Review Questions

### Multiple Choice

- A \_\_\_\_\_ structure executes a set of statements only under certain circumstances.
  - sequence
  - circumstantial
  - decision
  - Boolean
- A \_\_\_\_\_ structure provides one alternative path of execution.
  - sequence
  - single-alternative decision
  - one-path alternative
  - single-execution decision
- A(n) \_\_\_\_\_ expression has a value of either true or false.
  - binary
  - decision
  - unconditional
  - Boolean
- The symbols >, <, and == are all \_\_\_\_\_ operators.
  - relational
  - logical
  - conditional
  - ternary

5. A \_\_\_\_\_ structure tests a condition and then takes one path if the condition is true or another path if the condition is false.
  - a. multibranch statement
  - b. single-alternative decision
  - c. dual-alternative decision
  - d. sequence
6. You use a(n) \_\_\_\_\_ statement to write a single-alternative decision structure.
  - a. test-jump
  - b. if
  - c. if-else
  - d. if-call
7. You use a(n) \_\_\_\_\_ statement to write a dual alternative decision structure.
  - a. test-jump
  - b. if
  - c. if-else
  - d. if-call
8. A \_\_\_\_\_ decision structure is written inside another decision structure.
  - a. nested
  - b. tiered
  - c. dislodged
  - d. hierarchical
9. `&&`, `||`, and `!` are \_\_\_\_\_ operators.
  - a. relational
  - b. logical
  - c. conditional
  - d. ternary
10. A compound Boolean expression created with the \_\_\_\_\_ operator is true only if both of its subexpressions are true.
  - a. `&&`
  - b. `||`
  - c. `!`
  - d. both
11. A compound Boolean expression created with the \_\_\_\_\_ operator is true if either of its subexpressions is true.
  - a. `&&`
  - b. `||`
  - c. `!`
  - d. either
12. The \_\_\_\_\_ operator takes a Boolean expression as its operand and reverses its logical value.
  - a. `&&`
  - b. `||`
  - c. `!`
  - d. either
13. A \_\_\_\_\_ is a Boolean variable that signals when some condition exists in the program.
  - a. flag
  - b. signal

- c. sentinel
  - d. siren
14. The \_\_\_\_\_ family of methods can be used to convert a string to a specific data type without throwing an exception.
    - a. TryConvert
    - b. Parse
    - c. TryParse
    - d. SafeConvert
  15. If several \_\_\_\_\_ controls exist in a GroupBox, only one of them may be selected at a time.
    - a. CheckBox
    - b. RadioButton
    - c. ListBox
    - d. SelectionButton
  16. You use the \_\_\_\_\_ statement to create a multiple alternative decision structure.
    - a. menu
    - b. branch
    - c. select
    - d. switch
  17. The \_\_\_\_\_ section of a switch statement is branched to if none of the case values match the test expression.
    - a. else
    - b. default
    - c. case
    - d. otherwise
  18. A ListBox's index numbering starts at \_\_\_\_\_.
    - a. 0
    - b. 1
    - c. -1
    - d. any value you specify
  19. You can use the \_\_\_\_\_ property to determine whether an item is selected in a ListBox.
    - a. Index
    - b. SelectedItem
    - c. SelectedIndex
    - d. Items.SelectedIndex
  20. The \_\_\_\_\_ property holds the item that is selected in a ListBox control.
    - a. Index
    - b. SelectedItem
    - c. SelectedIndex
    - d. Items.SelectedIndex

### True or False

1. You can write any program using only sequence structures.
2. A single-alternative decision structure tests a condition and then takes one path if the condition is true or another path if the condition is false.
3. The `if-else` statement is a dual-alternative decision structure.

4. A decision structure can be nested inside another decision structure.
5. A compound Boolean expression created with the `&&` operator is true only when both subexpressions are true.
6. The `TryParse` methods throw an exception if the string argument cannot be converted.
7. Multiple `CheckBox` controls in the same `GroupBox` can be selected at the same time.
8. The test expression in a `switch` statement can be a `double` or a `decimal` value.
9. If an item is not selected in a `ListBox`, the control's `SelectedIndex` property will be set to 0.
10. To store items in a `ListBox`, you add them to the control's `Text` property.

### Short Answer

1. What is meant by the term *conditionally executed*?
2. You need to test a condition and then execute one set of statements if the condition is true. If the condition is false, you need to execute a different set of statements. What structure will you use?
3. Briefly describe how the `&&` operator works.
4. Briefly describe how the `||` operator works.
5. When determining whether a number is inside a range, which logical operator is it best to use?
6. What is a flag and how does it work?
7. What are the two arguments that you pass to a `TryParse` method?
8. How do you determine in code whether a `RadioButton` control or a `CheckBox` control is selected?
9. How do you add items to a `ListBox` using the *Properties* window?
10. How can you read the selected item from a `ListBox` while preventing an exception from occurring if no item is selected?

### Algorithm Workbench

1. Write an `if` statement that assigns 20 to the variable `y` and assigns 40 to the variable `z` if the variable `x` is greater than 100.
2. Write an `if` statement that assigns 0 to the variable `b` and assigns 1 to the variable `c` if the variable `a` is less than 10.
3. Write an `if-else` statement that assigns 0 to the variable `b` if the variable `a` is less than 10. Otherwise, it should assign 99 to the variable `b`.
4. Write nested decision structures that perform the following: if `amount1` is greater than 10 and `amount2` is less than 100, display the greater of `amount1` and `amount2`.
5. Write an `if-else` statement that displays "Speed is normal" if the value of the `speed` variable is at least 24 but no more than 56. If the `speed` variable's value is outside this range, display "Speed is abnormal."
6. Write an `if-else` statement that determines whether the value of the `points` variable is less than 9 or greater than 51. If this is true, display "Invalid points." Otherwise, display "Valid points."

7. Assume `pointsTextBox` is the name of a `TextBox` control and `points` is the name of an `int` variable. Write an `if-else` statement that uses one of the `TryParse` methods to convert the `pointsTextBox` control's `Text` property to an `int` and stores the result in the `points` variable. If the conversion is not successful, display an error message in a message box.
8. Rewrite the following `if-else-if` statement as a `switch` statement.

```

if (selection == 1)
{
    MessageBox.Show("You selected 1.");
}
else if (selection == 2)
{
    MessageBox.Show("You selected 2.");
}
else if (selection == 3)
{
    MessageBox.Show("You selected 3.");
}
else if (selection == 4)
{
    MessageBox.Show("You selected 4.");
}
else
{
    MessageBox.Show("Not good with numbers, eh?");
}

```

9. Assume `nameListBox` is a `ListBox` control. Write code that reads the selected item from the `ListBox`. Be sure to prevent an exception from occurring in case no item has been selected.

## Programming Problems

### 1. Roman Numeral Converter

Create an application that allows the user to enter an integer between 1 and 10 into a `TextBox` control. The program should display the Roman numeral version of that number. If the number is outside the range of 1 through 10, the program should display an error message.

The following table lists the Roman numerals for the numbers 1 through 10.

Number	Roman Numeral
1	I
2	II
3	III
4	IV
5	V
6	VI
7	VII
8	VIII
9	IX
10	X



VideoNote

Solving the  
Mass and  
Weight  
Problem

## 2. Mass and Weight

Scientists measure an object's mass in kilograms and its weight in Newtons. If you know the amount of mass of an object, you can calculate its weight, in Newtons, with the following formula:

$$\text{Weight} = \text{Mass} \times 9.8$$

Create an application that lets the user enter an object's mass and then calculates its weight. If the object weighs more than 1000 Newtons, display a message indicating that it is too heavy. If the object weighs less than 10 Newtons, display a message indicating that it is too light.

## 3. Magic Dates

The date June 10, 1960, is special because when it is written in the following format, the month times the day equals the year:

$$6/10/60$$

Create an application that lets the user enter a month (in numeric form), a day, and a two-digit year. The program should then determine whether the month times the day equals the year. If so, it should display a message saying the date is magic. Otherwise, it should display a message saying the date is not magic.

## 4. Color Mixer

The colors red, blue, and yellow are known as the primary colors because they cannot be made by mixing other colors. When you mix two primary colors, you get a secondary color, as shown here:

- When you mix red and blue, you get purple.
- When you mix red and yellow, you get orange.
- When you mix blue and yellow, you get green.

Create an application that lets the user select two primary colors from two different sets of *Radio* buttons. The form should also have a *Mix* button. When the user clicks the *Mix* button, the form's background should change to the color that you get when you mix the two selected primary colors. Figure 4-34 shows an example of how the form should appear.

**Figure 4-34** The *Color Mixer* form



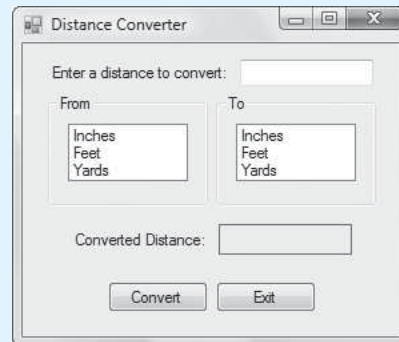
*Note:* If the user picks the same color from both sets of *Radio* buttons, set the form's background to that color.

## 5. Distance Converter

In the English measurement system, 1 yard equals 3 feet and 1 foot equals 12 inches. Use this information to create an application that lets the user convert distances to and from inches, feet, and yards.

Figure 4-35 shows an example of how the application's form might appear. In the example, the user enters the distance to be converted into a TextBox. A ListBox allows the user to select the units being converted from, and another ListBox allows the user to select the units being converted to.

**Figure 4-35** The *Distance Converter* form



*Note:* Be sure to handle the situation where the user picks the same units from both list boxes. The converted value will be the same as the value entered.

## 6. Book Club Points

Serendipity Booksellers has a book club that awards points to its customers based on the number of books purchased each month. The points are awarded as follows:

- If a customer purchases 0 books, he or she earns 0 points.
- If a customer purchases 1 book, he or she earns 5 points.
- If a customer purchases 2 books, he or she earns 15 points.
- If a customer purchases 3 books, he or she earns 30 points.
- If a customer purchases 4 or more books, he or she earns 60 points.

Create an application that lets the user enter the number of books that he or she has purchased this month and displays the number of points awarded.

## 7. Software Sales

A software company sells a package that retails for \$99. Quantity discounts are given according to the following table:

Quantity	Discount
10–19	20%
20–49	30%
50–99	40%
100 or more	50%

Create an application that lets the user enter the number of packages purchased. The program should then display the amount of the discount (if any) and the total amount of the purchase after the discount.

## 8. Body Mass Index Program Enhancement

In Programming Problem 6 in Chapter 3, you were asked to create an application that calculates a person's body mass index (BMI). Recall from that exercise that the BMI is often used to determine whether a person is overweight or underweight for their height. A person's BMI is calculated with the following formula:

$$BMI = Weight \times 703 \div Height^2$$

In the formula, weight is measured in pounds and height is measured in inches. Enhance the program so it displays a message indicating whether the person has optimal weight, is underweight, or is overweight. A person's weight is considered



to be optimal if his or her BMI is between 18.5 and 25. If the BMI is less than 18.5, the person is considered to be underweight. If the BMI value is greater than 25, the person is considered to be overweight.

#### 9. Change for a Dollar Game

Create a change-counting game that gets the user to enter the number of coins required to make exactly one dollar. The program should let the user enter the number of pennies, nickels, dimes, and quarters. If the total value of the coins entered is equal to one dollar, the program should congratulate the user for winning the game. Otherwise, the program should display a message indicating whether the amount entered was more than or less than one dollar.

#### 10. Fat Percentage Calculator

One gram of fat has 9 calories. If you know the number of fat grams in a particular food, you can use the following formula to calculate the number of calories that come from fat in that food:

$$\text{Calories from fat} = \text{Fat grams} \times 9$$

If you know the food's total calories, you can use the following formula to calculate the percentage of calories from fat:

$$\text{Percentage of calories from fat} = \text{Calories from fat} \div \text{Total calories}$$

Create an application that allows the user to enter:

- The total number of calories for a food item
- The number of fat grams in that food item

The application should calculate and display:

- The number of calories from fat
- The percentage of calories that come from fat

Also, the application's form should have a `CheckBox` that the user can check if he or she wants to know whether the food is considered low fat. (If the calories from fat are less than 30% of the total calories of the food, the food is considered low fat.)

Use the following test data to determine if the application is calculating properly:

Calories and Fat	Percentage Fat
200 calories, 8 fat grams	Percentage of calories from fat: 36%
150 calories, 2 fat grams	Percentage of calories from fat: 12% (a low-fat food)
500 calories, 30 fat grams	Percentage of calories from fat: 54%

*Note:* Make sure the number of calories and fat grams are not less than 0. Also, the number of calories from fat cannot be greater than the total number of calories. If that happens, display an error message indicating that either the calories or fat grams were incorrectly entered.

#### 11. Time Calculator

Create an application that lets the user enter a number of seconds and works as follows:

- There are 60 seconds in a minute. If the number of seconds entered by the user is greater than or equal to 60, the program should display the number of minutes in that many seconds.
- There are 3,600 seconds in an hour. If the number of seconds entered by the user is greater than or equal to 3,600, the program should display the number of hours in that many seconds.
- There are 86,400 seconds in a day. If the number of seconds entered by the user is greater than or equal to 86,400, the program should display the number of days in that many seconds.

## 12. Workshop Selector

The following table shows a training company's workshops, the number of days of each, and their registration fees.

Workshop	Number of Days	Registration Fee
Handling Stress	3	\$1,000
Time Management	3	\$800
Supervision Skills	3	\$1,500
Negotiation	5	\$1,300
How to Interview	1	\$500

The training company conducts its workshops in the six locations shown in the following table. The table also shows the lodging fees per day at each location.

Location	Lodging Fees per Day
Austin	\$150
Chicago	\$225
Dallas	\$175
Orlando	\$300
Phoenix	\$175
Raleigh	\$150

When a customer registers for a workshop, he or she must pay the registration fee plus the lodging fees for the selected location. For example, here are the charges to attend the Supervision Skills workshop in Orlando:

**Registration:** \$1,500

**Lodging:**  $\$300 \times 3 \text{ days} = \$900$

**Total:** \$2,400

Create an application that lets the user select a workshop from one ListBox and a location from another ListBox. When the user clicks a button, the application should calculate and display the registration cost, the lodging cost, and the total cost.

*This page intentionally left blank*

## TOPICS

- |     |                         |     |  |
|-----|-------------------------|-----|--|
| 5.1 | More about ListBoxes    | 5.6 | Using Files for Data Storage                   |
| 5.2 | The while Loop          | 5.7 | The OpenFileDialog and SaveFileDialog Controls |
| 5.3 | The ++ and -- operators | 5.8 | Random Numbers                                 |
| 5.4 | The for Loop            | 5.9 | The Load Event                                 |
| 5.5 | The do-while Loop       |     |  |

## 5.1 More about ListBoxes

**CONCEPT:** ListBox controls have various methods and properties that you can use in code to manipulate the ListBox's contents.

In Chapter 4 we introduced the ListBox control, which displays a list of items and allows the user to select one or more items from the list. In this chapter we use ListBox controls to display output. Many of the algorithms that you will see in this chapter generate lists of data and then display those lists in ListBox controls.

Recall from Chapter 4 that you add items to a ListBox control's Items property, and those items are displayed in the ListBox. At design time, you can use the *Properties* window to add items to the control's Items property. You can also write code that adds items to a ListBox control at run time. To add an item to a ListBox control with code, you call the control's **Items.Add** method. Here is the method's general format:

```
ListBoxName.Items.Add(Item);
```

*ListBoxName* is the name of the ListBox control. *Item* is the value to be added to the Items property. For example, in the *Chap05* folder of this book's Student Sample Programs, you will find a project named *Name List*. Figure 5-1 shows the application's form. As shown in the image on the left, the ListBox's name is `nameListBox` and the Button control's name is `addButton`. At run time, when you click the `addButton` control, the names shown in the image on the right are added to the `nameListBox` control.

**Figure 5-1** The *Name List* application

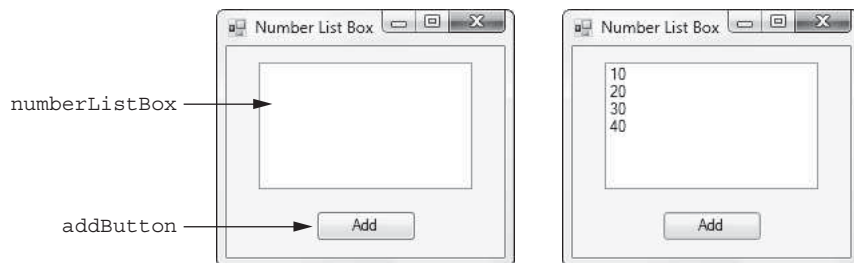
Here is the code for the `addButton_Click` event handler:

```

1 private void addButton_Click(object sender, EventArgs e)
2 {
3     namesListBox.Items.Add("Chris");
4     namesListBox.Items.Add("Alicia");
5     namesListBox.Items.Add("Justin");
6     namesListBox.Items.Add("Holly");
7 }

```

You can add values of other types as well. In the *Chap05* folder of the book's Student Sample Programs, you will find a project named *Number List*. Figure 5-2 shows the application's form. As shown in the image on the left, the `ListBox`'s name is `numberListBox` and the `Button` control's name is `addButton`. At run time, when you click the `addButton` control, the numbers shown in the image on the right are added to the `numberListBox` control.

**Figure 5-2** The *Number List* application

Here is the code for the `addButton_Click` event handler:

```

1 private void addButton_Click(object sender, EventArgs e)
2 {
3     numberListBox.Items.Add(10);
4     numberListBox.Items.Add(20);
5     numberListBox.Items.Add(30);
6     numberListBox.Items.Add(40);
7 }

```

## The `Items.Count` Property

`ListBox` controls have an `Items.Count` property that reports the number of items stored in the `ListBox`. If the `ListBox` is empty, the `Items.Count` property equals 0. For example,

assume an application has a `ListBox` control named `employeesListBox`. The following `if` statement displays a message box if there are no items in the `ListBox`:

```
if (employeesListBox.Items.Count == 0)
{
    MessageBox.Show("There are no items in the list!");
}
```

The `Items.Count` property holds an integer value. Assuming `numEmployees` is an `int` variable, the following statement assigns the number of items in the `employeesListBox` to the `numEmployees` variable:

```
numEmployees = employeesListBox.Items.Count;
```

## The Items.Clear Method

`ListBox` controls have an `Items.Clear` method that erases all the items in the `Items` property. Here is the method's general format:

```
ListBoxName.Items.Clear();
```

For example, assume an application has a `ListBox` control named `employeesListBox`. The following statement clears all the items in the list.

```
employeesListBox.Items.Clear();
```



### Checkpoint

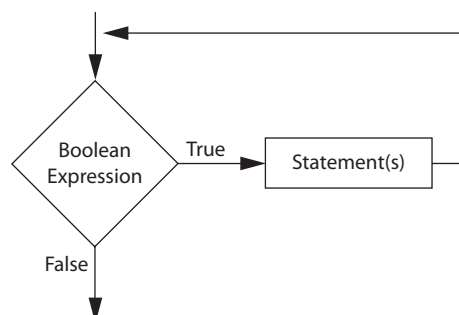
- 5.1 In code, how do you add an item to a `ListBox` control?
- 5.2 How do you determine the number of items that are stored in a `ListBox` control?
- 5.3 How do you erase the contents of a `ListBox` control?

## 5.2 The while Loop

**CONCEPT:** The `while` loop causes a statement or set of statements to repeat as long as a Boolean expression is true.

The `while` loop gets its name from the way it works: *While a Boolean expression is true, do some task*. The loop has two parts: (1) a Boolean expression that is tested for a true or false value and (2) a statement or set of statements that is repeated as long as the Boolean expression is true. Figure 5-3 shows the logic of a `while` loop.

**Figure 5-3** The logic of a `while` loop



The diamond symbol represents the Boolean expression that is tested. Notice what happens if the expression is true: One or more statements are executed and the program's execution flows back to the point just above the diamond symbol. The Boolean expression is tested again, and if it is true, the process repeats. If the Boolean expression is false, the program exits the loop. Each time the loop executes its statement or statements, we say the loop is iterating, or performing an **iteration**.

Here is the general format of the `while` loop:

```
while (BooleanExpression)
{
    statement;
    statement;
    etc.
}
```

] This set of statements is repeated while the Boolean expression is true.

We refer to the first line as the **while clause**. The `while` clause begins with the word `while`, followed by a Boolean expression that is enclosed in parentheses. Beginning on the next line is a set of statements enclosed in curly braces. This block of statements is known as the **body** of the loop.

When the `while` loop executes, the Boolean expression is tested. If the Boolean expression is true, the statements that appear in the body of the loop are executed, and then the loop starts over. If the Boolean expression is false, the loop ends and the program resumes execution at the statement immediately following the loop.

We say that the statements in the body of the loop are conditionally executed because they are executed only under the condition that the Boolean expression is true. If you are writing a `while` loop that has only one statement in its body, you do not have to enclose the statement inside curly braces. Such a loop can be written in the following general format:

```
while (BooleanExpression)
    statement;
```

When a `while` loop written in this format executes, the Boolean expression is tested. If it is true, the one statement that appears on the next line is executed, and then the loop starts over. If the Boolean expression is false, however, the loop ends.

Although the curly braces are not required when there is only one statement in the loop's body, it is still a good idea to use them, as shown in the following general format:

```
while (BooleanExpression)
{
    statement;
}
```

When we discussed the various `if` statements in Chapter 4, we mentioned that this is a good style of programming because it cuts down on errors. If you have more than one statement in the body of a loop, those statements *must* be enclosed in curly braces. If you get into the habit of always enclosing the conditionally executed statements in a set of curly braces, it's less likely that you will forget them.

You should also notice that the statements in the body of the loop are indented. As with `if` statements, this indentation makes the code easier to read and debug. By indenting the statements in the body of the loop, you visually set them apart from the surrounding code.

Let's look at an example. In the *Chap05* folder of this book's Student Sample Programs, you will find a project named *while Loop Demo*. Figure 5-4 shows the application's form. As shown in the image on the left, the Button control's name is `goButton`. At run time, when you click the `goButton` control, the message box shown in the image on the right

**Figure 5-4** The *while Loop Demo* application

is displayed. When you click the *OK* button to close the message box, another identical message box is displayed. The message box is displayed a total of five times.

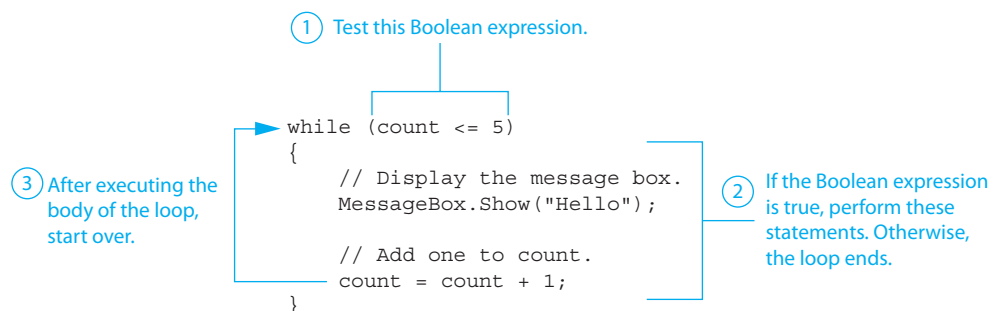
Here is the code for the `goButton_Click` event handler:

```

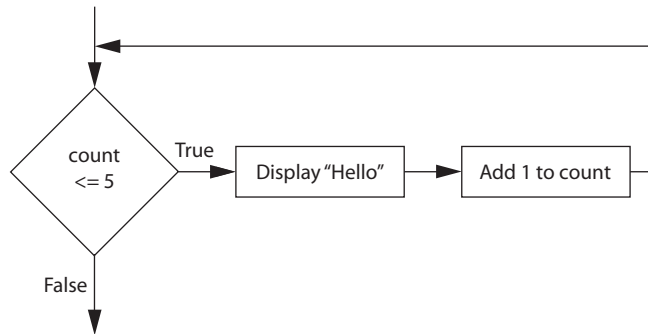
1 private void goButton_Click(object sender, EventArgs e)
2 {
3     // Declare a variable to count the loop iterations.
4     int count = 1;
5
6     // Display "Hello" in a message box five times.
7     while (count <= 5)
8     {
9         // Display the message box.
10        MessageBox.Show("Hello");
11
12        // Add one to count.
13        count = count + 1;
14    }
15 }

```

Let's take a closer look at this code. In line 4 an `int` variable named `count` is declared and initialized with the value 1. A `while` loop begins in line 7. Notice that the `while` loop tests the expression `count <= 5`. The statements in the body of the `while` loop repeat as long as the `count` variable is less than or equal to 5. Inside the body of the loop, line 10 displays "Hello" in a message box, and then line 13 adds one to the `count` variable. This is the last statement in the body of the loop, so after it executes, the loop starts over. It tests the Boolean expression again, and if it is true, the statements in the body of the loop are executed. This cycle repeats until the Boolean expression `count <= 5` is false, as illustrated in Figure 5-5. A flowchart for the loop is shown in Figure 5-6.

**Figure 5-5** The *while* Loop



**Figure 5-6** Flowchart for the `while` Loop

## The `while` Loop Is a Pretest Loop

The `while` loop is known as a **pretest loop**, which means it tests its condition *before* performing an iteration. Because the test is done at the beginning of the loop, you usually have to perform some steps prior to the loop to make sure that the loop executes at least once. Notice the declaration of the `count` variable in the *while Loop Demo* program:

```
int count = 1;
```

The `count` variable is initialized with the value 1. If `count` had been initialized with a value that is greater than 5, as shown in the following program sample, the loop would never execute:

```

1 private void goButton_Click(object sender, EventArgs e)
2 {
3     // Declare a variable to count the loop iterations.
4     int count = 6;
5
6     // This loop will never iterate!
7     while (count <= 5)
8     {
9         // Display the message box.
10        MessageBox.Show("Hello");
11
12        // Add one to count.
13        count = count + 1;
14    }
15 }

```

An important characteristic of the `while` loop is that the loop will never iterate if the Boolean expression is false to start with. If you want to be sure that a `while` loop executes the first time, you must initialize the relevant data in such a way that the Boolean expression starts out as true.

## Counter Variables

In the *while Loop Demo* application, the variable `count` is initialized with the value 1, and then 1 is added to the variable `count` during each loop iteration. The loop executes as long as `count` is less than or equal to 5. The variable `count` is used as a **counter variable**, which means it is regularly incremented in each loop iteration. In essence, the `count` variable keeps count of the number of iterations the loop has performed. Counter variables are commonly used to control the number of times that a loop iterates.

Tutorial 5-1 will give you some practice writing a loop and using a counter variable. In the tutorial you will write a `while` loop that calculates the amount of interest earned by a bank account each month for a number of months.



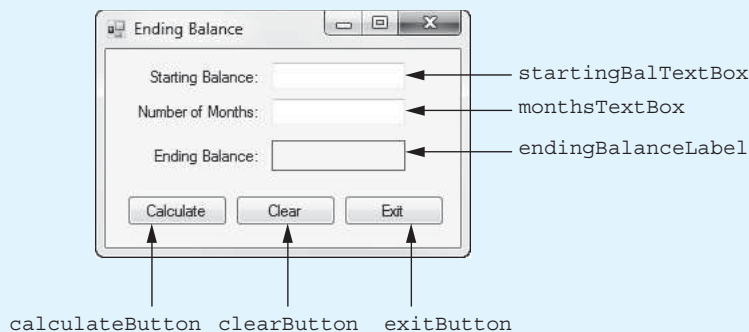
**Tutorial 5-1:**  
Using a Loop to Calculate an Account Balance



## Tutorial 5-1: Using a Loop to Calculate an Account Balance

In this tutorial you complete the *Ending Balance* application. The project has already been started for you and is located in the *Chap05* folder of this book's Student Sample Programs. The application's form is shown in Figure 5-7.

**Figure 5-7** The *Ending Balance* form



When you complete the application, it will allow the user to enter an account's starting balance into the `startingBalTextBox` control and the number of months that the account will be left to earn interest into the `monthsTextBox` control. When the user clicks the `calculateButton` control, the application calculates the account's balance at the end of the time period. The account's monthly interest rate is 0.005, and the interest is compounded monthly.

**Step 1:** Start Visual Studio (or Visual Studio Express). Open the project named *Ending Balance* in the *Chap05* folder of this book's Student Sample Programs.

**Step 2:** Open the `Form1` form in the *Designer*. The form is shown, along with the names of the important controls, in Figure 5-7.

**Step 3:** Now you will create the Click event handlers for the Button controls. At the end of this tutorial, Program 5-1 shows the completed code for the form. You will be instructed to refer to Program 5-1 as you write the event handlers.

In the *Designer*, double-click the `calculateButton` control. This opens the code editor, and you will see an empty event handler named `calculateButton_Click`. Complete the `calculateButton_Click` event handler by typing the code shown in lines 22–59 in Program 5-1. Let's take a closer look at the code:

**Line 23:** This statement declares a constant `decimal` named `INTEREST_RATE`, set to the value 0.005. This is the monthly interest rate.

**Lines 26–28:** These statements declare the following variables:

- `balance`, a `decimal` variable to hold the account balance.
- `months`, an `int` variable to hold the number of months that the account will be left to earn interest.
- `count`, an `int` that is used to count the months as a loop iterates. Notice that the `count` variable is initialized with the value 1.

**Line 31:** This `if` statement tries to convert `startingBalTextBox.Text` to a `decimal`. If the conversion is successful, the result is stored in the `balance` variable, and the program continues executing at line 33. If the conversion is not successful, the program jumps to the `else` clause in line 55, and line 58 displays the error message *Invalid value for starting balance*.

**Line 34:** This `if` statement tries to convert `monthsTextBox.Text` to an `int`. If the conversion is successful, the result is stored in the `months` variable, and the program continues executing at line 36. If the conversion is not successful, the program jumps to the `else` clause in line 49, and line 52 displays the error message *Invalid value for months*.

**Line 37:** This is the beginning of a `while` loop. The loop executes as long as the expression `count <= months` is true.

**Lines 39–43:** These statements are the body of the loop. Line 40 calculates the monthly interest and adds it to the `balance` variable. Line 43 adds 1 to the `count` variable.

**Line 47:** This statement executes after the loop has finished all of its iterations. It converts the value of the `balance` variable to a string (formatted as currency) and assigns the resulting string to the `endingBalanceLabel` control's `Text` property.

**Step 4:** Switch your view back to the *Designer* and double-click the `clearButton` control. In the code editor you will see an empty event handler named `clearButton_Click`. Complete the `clearButton_Click` event handler by typing the code shown in lines 64–70 in Program 5-1.

**Step 5:** Switch your view back to the *Designer* and double-click the `exitButton` control. In the code editor you will see an empty event handler named `exitButton_Click`. Complete the `exitButton_Click` event handler by typing the code shown in lines 75–76 in Program 5-1.

**Step 6:** Save the project. Then, press `[F5]` on the keyboard, or click the *Start Debugging* button (🐞) on the toolbar to compile and run the application.

First, enter **1000** as the starting balance and **48** as the number of months. Click the *Calculate Average* button and \$1,270.49 should appear as the ending balance. Think about the value that you entered for the number of months. How many times did the `while` loop in line 36 iterate? (Answer: 48 times.)

Next, click the *Clear* button to clear the `TextBoxes` and the ending balance. Now, enter **100** as the starting balance and **1** as the number of months. Click the *Calculate Average* button and \$100.50 should appear as the ending balance. How many times did the `while` loop iterate this time? (Answer: 1 time.)

Continue to test the application as you wish. When you are finished, click the *Exit* button and the form should close. (If you plan to continue to the next tutorial, leave this project open in Visual Studio.)

### Program 5.1 Completed Form1 code for the *Ending Balance* application

```

1 using System;
2 using System.Collections.Generic;
3 using System.ComponentModel;
4 using System.Data;
5 using System.Drawing;

```

```

6 using System.Linq;
7 using System.Text;
8 using System.Threading.Tasks;
9 using System.Windows.Forms;
10
11 namespace Ending_Balance
12 {
13     public partial class Form1 : Form
14     {
15         public Form1()
16         {
17             InitializeComponent();
18         }
19
20         private void calculateButton_Click(object sender, EventArgs e)
21         {
22             // Constant for the monthly interest rate.
23             const decimal INTEREST_RATE = 0.005m;
24
25             // Local variables
26             decimal balance; // The account balance
27             int months; // The number of months
28             int count = 1; // Loop counter, initialized with 1
29
30             // Get the starting balance.
31             if (decimal.TryParse(startingBalTextBox.Text, out balance))
32             {
33                 // Get the number of months.
34                 if (int.TryParse(monthsTextBox.Text, out months))
35                 {
36                     // The following loop calculates the ending balance.
37                     while (count <= months)
38                     {
39                         // Add this month's interest to the balance.
40                         balance = balance + (INTEREST_RATE * balance);
41
42                         // Add one to the loop counter.
43                         count = count + 1;
44                     }
45
46                     // Display the ending balance.
47                     endingBalanceLabel.Text = balance.ToString("c");
48                 }
49                 else
50                 {
51                     // Invalid number of months was entered.
52                     MessageBox.Show("Invalid value for months.");
53                 }
54             }
55             else
56             {
57                 // Invalid starting balance was entered.
58                 MessageBox.Show("Invalid value for starting balance.");
59             }
60         }
61
62         private void clearButton_Click(object sender, EventArgs e)
63         {
64             // Clear the TextBoxes and the endingBalanceLabel control.

```

```

65         startingBalTextBox.Text = "";
66         monthsTextBox.Text = "";
67         endingBalanceLabel.Text = "";
68
69         // Reset the focus.
70         startingBalTextBox.Focus();
71     }
72
73     private void exitButton_Click(object sender, EventArgs e)
74     {
75         // Close the form.
76         this.Close();
77     }
78 }
79 }

```



## Tutorial 5-2: Enhancing the *Ending Balance* Application

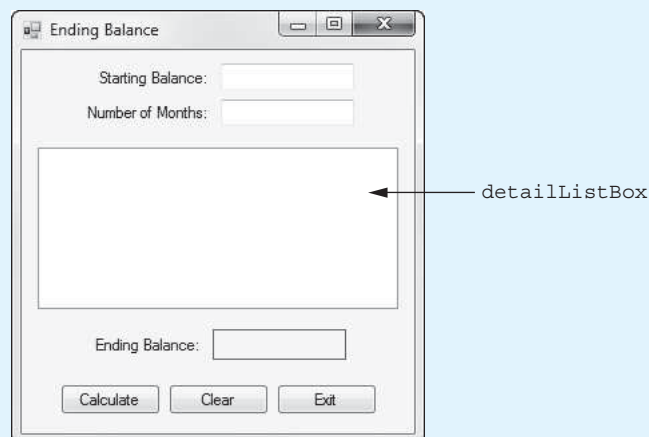


VideoNote

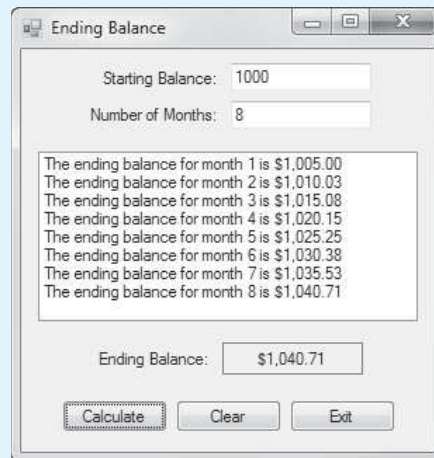
**Tutorial 5-2:**  
Enhancing  
the *Ending  
Balance*  
Application

In this tutorial you enhance the *Ending Balance* application that you created in Tutorial 5-1. First, add a `ListBox` control to the application's form, as shown in Figure 5-8. Then modify the `calculateButton_Click` event handler so it displays each month's ending balance in the `ListBox`. Figure 5-9 shows an example of how the form will appear when the user has entered 1000 for the starting balance and 8 for the months.

**Figure 5-8** The modified *Ending Balance* form



- Step 1:** Start Visual Studio (or Visual Studio Express) and open the *Ending Balance* project that you completed in Tutorial 5-1.
- Step 2:** Enlarge the form so it is roughly the size shown in Figure 5-8. (310 pixels wide by 325 pixels high should be sufficient.)
- Step 3:** Create a `ListBox` control named `detailListBox`. Resize the `ListBox` as shown in Figure 5-8.

**Figure 5-9** Example output

**Step 4:** Switch to the code editor and insert the code shown in lines 42–45 in Program 5-2. (The new lines of code are shown in bold.) The statement in lines 43–45 adds a string to the `detailListBox` control. If you examine the statement carefully, you will see that it uses concatenation to create a string in the following format:

The ending balance for month *count* is *balance*.

In the actual string that is created, *count* will be the value of the `count` variable and *balance* will be the value of the `balance` variable, formatted as currency.

**Step 5:** Find the `clearButton_Click` event handler in the code editor. Update the comment as shown in lines 69–70, and insert the line of code shown in line 74. (The lines are shown in bold.) The statement in line 74 clears the contents of the `detailListBox` control.

**Step 6:** Save the project. Then, press **F5** on the keyboard or click the *Start Debugging* button (▶) on the toolbar to compile and run the application.

As shown in Figure 5-9, enter *1000* as the starting balance and *8* as the number of months. Click the *Calculate Average* button. Your output should look like that shown in Figure 5-9. Click the *Clear* button and enter any other values you wish to test the application further. When you are finished, click the *Exit* button and the form should close.

### Program 5.2 Completed Form1 code for the *Ending Balance* application

```

1 using System;
2 using System.Collections.Generic;
3 using System.ComponentModel;
4 using System.Data;
5 using System.Drawing;
6 using System.Linq;
7 using System.Text;
8 using System.Threading.Tasks;
9 using System.Windows.Forms;
10
11 namespace Ending_Balance
12 {

```

```

13 public partial class Form1 : Form
14 {
15     public Form1()
16     {
17         InitializeComponent();
18     }
19
20     private void calculateButton_Click(object sender, EventArgs e)
21     {
22         // Constant for the monthly interest rate.
23         const decimal INTEREST_RATE = 0.005m;
24
25         // Local variables
26         decimal balance;           // The account balance
27         int months;                // The number of months
28         int count = 1;            // Loop counter, initialized with 1
29
30         // Get the starting balance.
31         if (decimal.TryParse(startingBalTextBox.Text, out balance))
32         {
33             // Get the number of months.
34             if (int.TryParse(monthsTextBox.Text, out months))
35             {
36                 // The following loop calculates the ending balance.
37                 while (count <= months)
38                 {
39                     // Add this month's interest to the balance.
40                     balance = balance + (INTEREST_RATE * balance);
41
42                     // Display this month's ending balance.
43                     detailListBox.Items.Add("The ending balance " +
44                         "for month " + count + " is " +
45                         balance.ToString("c"));
46
47                     // Add one to the loop counter.
48                     count = count + 1;
49                 }
50
51                 // Display the ending balance.
52                 endingBalanceLabel.Text = balance.ToString("c");
53             }
54             else
55             {
56                 // Invalid number of months was entered.
57                 MessageBox.Show("Invalid value for months.");
58             }
59         }
60         else
61         {
62             // Invalid starting balance was entered.
63             MessageBox.Show("Invalid value for starting balance.");
64         }
65     }
66
67     private void clearButton_Click(object sender, EventArgs e)
68     {
69         // Clear the TextBoxes, the endingBalanceLabel control,
70         // and the ListBox.

```

```

71         startingBalTextBox.Text = "";
72         monthsTextBox.Text = "";
73         endingBalanceLabel.Text = "";
74         detailListBox.Items.Clear();
75
76         // Reset the focus.
77         startingBalTextBox.Focus();
78     }
79
80     private void exitButton_Click(object sender, EventArgs e)
81     {
82         // Close the form.
83         this.Close();
84     }
85 }
86 }

```

## Infinite Loops

In all but rare cases, loops must contain a way to terminate within themselves. This means that something inside the loop must eventually make the loop's Boolean expression false. The loop in Program 5-2 stops when the expression `count <= months` is false. If a loop does not have a way of stopping, it is called an infinite loop. An *infinite loop* continues to repeat until the program is interrupted. Infinite loops usually occur when the programmer forgets to write code inside the loop that makes the test condition false. In most circumstances you should avoid writing infinite loops.

The following code sample demonstrates an infinite loop. In line 1 the `count` variable is declared and initialized with the value 1. The `while` loop that begins in line 5 executes as long as `count` is less than or equal to 5. There is no code inside the loop to change the `count` variable's value, so the expression `count <= 5` in line 5 is always true. As a consequence, the loop has no way of stopping.

```

1 // Declare a variable to count the loop iterations.
2 int count = 1;
3
4 // How many times will this loop iterate?
5 while (count <= 5)
6 {
7     // Display the message box.
8     MessageBox.Show("Hello");
9 }

```

## Checkpoint

- 5.4 What is a loop iteration?
- 5.5 What is a counter variable?
- 5.6 What is a pretest loop?
- 5.7 Does the `while` loop test its condition before or after it performs an iteration?
- 5.8 What is an infinite loop?



## 5.3 The ++ and -- operators

**CONCEPT:** To increment a variable means to increase its value, and to decrement a variable means to decrease its value. C# provides special operators to increment and decrement variables.

To **increment** a variable means to increase its value and to **decrement** a variable means to decrease its value. Both of the following statements increment the variable `num` by 1:

```
num = num + 1;
num += 1;
```

And `num` is decremented by 1 in both the following statements:

```
num = num - 1;
num -= 1;
```

Incrementing and decrementing is so commonly done in programs that C# provides a set of simple unary operators designed just for incrementing and decrementing variables. The increment operator is `++`, and the decrement operator is `--`. The following statement uses the `++` operator to add 1 to `num`:

```
num++;
```

After this statement executes, the value of `num` is increased by 1. The following statement uses the `--` operator to subtract 1 from `num`:

```
num--;
```



**NOTE:** The `++` operator is pronounced “plus plus,” and the `--` operator is pronounced “minus minus.” The expression `num++` is pronounced “num plus plus,” and the expression `num--` is pronounced “num minus minus.”

In these examples, we have written the `++` and `--` operators after their operands (or, on the right side of their operands). This is called **postfix mode**. The operators can also be written before (or, on the left side) of their operands, which is called **prefix mode**. Here are examples:

```
++num;
--num;
```

When you write a simple statement to increment or decrement a variable, such as the ones shown here, it doesn’t matter if you use prefix mode or postfix mode. The operators do the same thing in either mode. However, if you write statements that mix these operators with other operators or with other operations, there is a difference in the way the two modes work. Such complex code can be difficult to understand and debug. When we use the increment and decrement operators, we will do so only in ways that are straightforward and easy to understand, such as the statements previously shown.

We introduce these operators at this point because they are commonly used in loops. The following code segment shows an example. In the code, the `count` variable is initialized with the value 1. The `while` loop that begins in line 5 iterates as long as `count` is less than or equal to 5. The statement in line 11 increments `count`. The loop will iterate 5 times.

```
1 // Declare a variable to count the loop iterations.
2 int count = 1;
```

```

3
4 // Display "Hello" in a message box five times.
5 while (count <= 5)
6 {
7     // Display the message box.
8     MessageBox.Show("Hello");
9
10    // Increment count.
11    count++;
12 }

```

In the next section, which discusses the `for` loop, you will see these operators used often.

## Checkpoint

5.9 What messages will the following code sample display?

```

int number = 5;
number++;
MessageBox.Show(number.ToString());
number--;
MessageBox.Show(number.ToString());

```

5.10 How many times will the following loop iterate?

```

int count = 0;
while (count < 4)
{
    MessageBox.Show(count.ToString());
    count++;
}

```

## 5.4 The for Loop

**CONCEPT:** The `for` loop is ideal for performing a known number of iterations.

The `for` loop is specifically designed for situations requiring a counter variable to control the number of times that a loop iterates. When you write a `for` loop, you specify three actions:

- **Initialization:** This action takes place when the loop begins. It happens only once.
- **Test:** A Boolean expression is tested. If the expression is true, the loop iterates. Otherwise, the loop stops.
- **Update:** This action takes place at the end of each loop iteration.

Figure 5-10 shows how these three actions are used in the logic of a `for` loop.

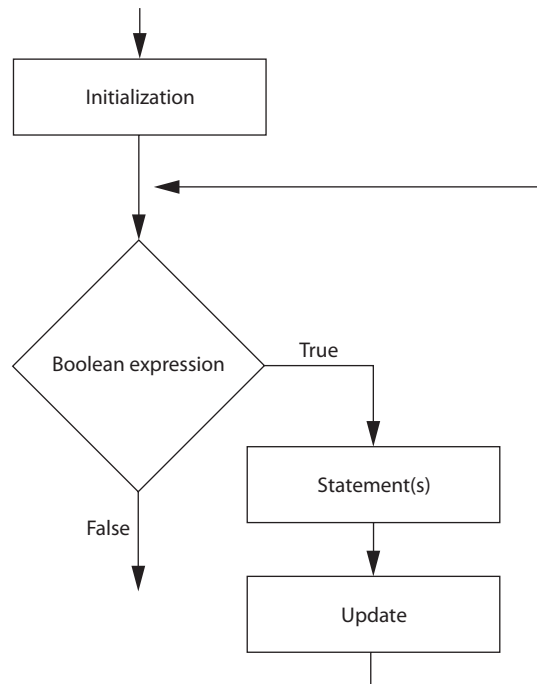
Here is the general format of the `for` loop:

```

for (InitializationExpression; TestExpression; UpdateExpression)
{
    statement;
    statement;
    etc.
}

```

The statements that appear inside the curly braces are the body of the loop. These are the statements that are executed each time the loop iterates. As with other control structures,

**Figure 5-10** Logic of a `for` loop

the curly braces are optional if the body of the loop contains only one statement, as shown in the following general format:

```

for (InitializationExpression; TestExpression; UpdateExpression)
    statement;
  
```

The first line of the `for` loop is the *loop header*. After the key word `for`, there are three expressions inside the parentheses, separated by semicolons. (Notice that there is not a semicolon after the third expression.)

The first expression is the **initialization expression**. It is normally used to initialize a counter variable to its starting value. This is the first action performed by the loop, and it is only done once. The second expression is the **test expression**. This is a Boolean expression that controls the execution of the loop. As long as this expression is true, the body of the `for` loop will repeat. The `for` loop is a pretest loop, so it evaluates the test expression before each iteration. The third expression is the **update expression**. It executes at the end of each iteration. Typically, this is a statement that increments the loop's counter variable.

Let's assume that `count` is an `int` variable that has already been declared. Here is an example of a simple `for` loop that displays "Hello" in a message box 5 times:

```

for (count = 1; count <= 5; count++)
{
    MessageBox.Show("Hello");
}
  
```

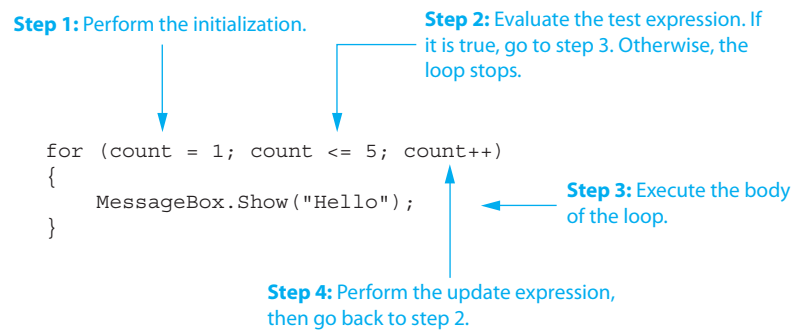
In this loop, the initialization expression is `count = 1`, the test expression is `count <= 5`, and the increment expression is `count++`. The body of the loop has one statement, which

is the call to `MessageBox.Show` method. This is a summary of what happens when this loop executes:

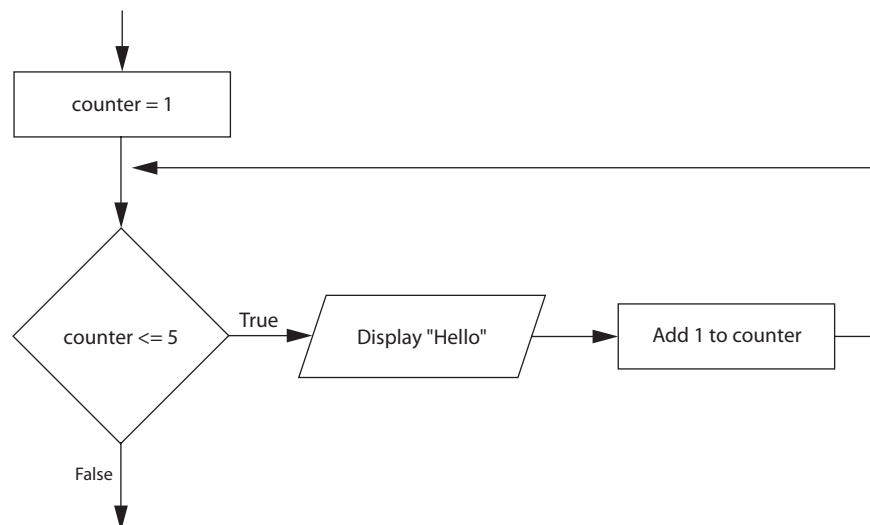
1. The initialization expression `count = 1` is executed. This assigns 1 to the `count` variable.
2. The expression `count <= 5` is tested. If the expression is true, continue with Step 3. Otherwise, the loop is finished.
3. The statement `MessageBox.Show("Hello");` is executed.
4. The update expression `count++` is executed. This adds 1 to the `count` variable.
5. Go back to Step 2.

Figure 5-11 illustrates this sequence of events. Notice that Steps 2–4 are repeated as long as the test expression is true. Figure 5-12 shows the logic of the loop as a flowchart.

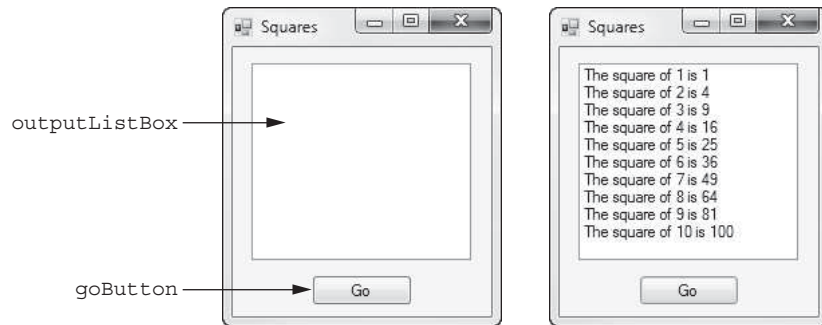
**Figure 5-11** Sequence of events in the `for` loop



**Figure 5-12** Logic of the `for` loop



Let's look at a complete application that uses a `for` loop. In the *Chap05* folder of this book's Student Sample Programs, you will find a project named *Squares*. The purpose of the application is to display the numbers 1–10 and their squares. Figure 5-13 shows the application's form. As shown in the image on the left, the `ListBox`'s name is `outputListBox` and the `Button` control's name is `goButton`. At run time, when you click the `goButton` control, the `outputListBox` control displays the program's output, as shown in the image on the right.

**Figure 5-13** The *Squares* application

Here is the code for the `goButton_Click` event handler:

```

1 private void goButton_Click(object sender, EventArgs e)
2 {
3     // Constant for the maximum number
4     const int MAX_VALUE = 10;
5
6     // Loop counter
7     int number;
8
9     // Display the list of numbers and their squares.
10    for (number = 1; number <= MAX_VALUE; number++)
11    {
12        outputListbox.Items.Add("The square of " +
13            number + " is " + (number * number));
14    }
15 }

```

Let's take a closer look at the code:

- Line 4 declares an `int` constant named `MAX_VALUE`, set to the value 10. This is the maximum number that we will use to calculate a square.
- Line 7 declares an `int` variable named `number`. This variable is used both as a counter variable and in the calculation of squares.
- Line 10 is the beginning of a `for` loop. You can see from this line that the loop works in the following way:
  - Initialization:** The `number` variable is initialized with the value 1.
  - Test:** The expression `number <= MAX_VALUE` is tested at the beginning of each iteration.
  - Update:** The expression `number++` is executed at the end of each iteration.
- Since the `MAX_VALUE` constant is set to the value 10, the `number` variable will be assigned the values 1 through 10 as the loop iterates.
- Lines 12 and 13: This statement adds a line to the `Listbox` showing the current value of the `number` variable, and the square of that value.

## The `for` Loop Is a Pretest Loop

Because the `for` loop tests its Boolean expression before it performs an iteration, it is a pretest loop. It is possible to write a `for` loop in such a way that it will never iterate. Here is an example:

```

for (count = 6; count <= 5; count++)
{
    MessageBox.Show("Hello");
}

```

Because the variable `count` is initialized to a value that makes the Boolean expression false from the beginning, this loop terminates as soon as it begins.

## Declaring the Counter Variable in the Initialization Expression

Not only may the counter variable be initialized in the initialization expression, but it may also be declared there. The following code shows an example:

```
for (int count = 1; count <= 5; count++)
{
    MessageBox.Show("Hello");
}
```

In this loop, the `count` variable is both declared and initialized in the initialization expression. If the variable is used only in the loop, it makes sense to define it in the loop header. This makes the variable's purpose clearer.

When a variable is declared in the initialization expression of a `for` loop, the scope of the variable is limited to the loop. This means you cannot access the variable in statements outside the loop. For example, the following code would cause a compiler error because the statement in line 6 cannot access the `count` variable.

```
1 for (int count = 1; count <= 5; count++)
2 {
3     MessageBox.Show("Hello");
4 }
5
6 MessageBox.Show("The value of count is " + count);
```

## Other Forms of the Update Expression

In the update expression, the counter variable is typically incremented by 1. This makes it convenient to use the `++` operator in the increment expression. This is not a requirement, however. You can write virtually any expression you wish as the update expression. For example, the following loop increments `count` by 10.

```
for (int count = 0; count <= 100; count += 10)
{
    MessageBox.Show(count.ToString());
}
```

Notice that in this example the increment expression is `count += 10`. This means that at the end of each iteration, 10 is added to `count`. During the first iteration `count` is set to 0, during the second iteration `count` is set to 10, during the third iteration `count` is set to 20, and so forth.

## Counting Backward by Decrementing the Counter Variable

Although the counter variable is usually incremented in a count-controlled loop, you can alternatively decrement the counter variable. For example, look at the following code:

```
for (int count = 10; count >= 0; count--)
{
    MessageBox.Show(count.ToString());
}
MessageBox.Show("Blastoff!");
```

In this loop the `count` variable is initialized with the value 10. The loop iterates as long as `count` is greater than or equal to 0. At the end of each iteration, `count` is decremented by 1.

During the first iteration count is 10, during the second iteration count is 9, and so forth. If this were in an actual program, it would display the numbers 10, 9, 8, and so forth, down to 0, and then display Blastoff!

## Avoiding Modifying the Counter Variable in the Body of the for Loop

Be careful not to place a statement that modifies the counter variable in the body of the for loop. All modifications of the control variable should take place in the update expression, which is automatically executed at the end of each iteration. If a statement in the body of the loop also modifies the counter variable, the loop probably will not terminate when you expect it to. The following loop, for example, increments count twice for each iteration:

```
for (int count = 1; count <= 10; count++)
{
    MessageBox.Show(count.ToString());
    count++; // Wrong!
}
```

You have seen several examples of the for loop. Tutorial 5-3 gives you an opportunity to write one. In the tutorial you will complete an application that uses a for loop to convert a series of measurements from the metric system to the English system.



### Tutorial 5-3: Using the for Loop



VideoNote

**Tutorial 5-3:**  
Using the  
for Loop

Your friend Amanda just inherited a European sports car from her uncle. Amanda lives in the United States, and she is afraid she will get a speeding ticket because the car's speedometer works in kilometers per hour. She has asked you to write a program that displays a table of speeds in kilometers per hour with their values converted to miles per hour. The formula for converting kilometers per hour to miles per hour is:

$$MPH = KPH * 0.6214$$

In the formula, *MPH* is the speed in miles per hour and *KPH* is the speed in kilometers per hour.

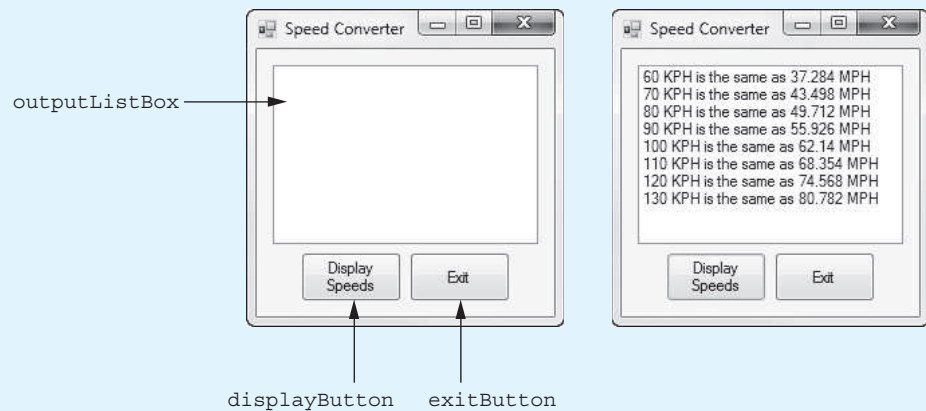
The table that your program displays should show speeds from 60 kilometers per hour through 130 kilometers per hour, in increments of 10, along with their values converted to miles per hour. The table should look something like this:

KPH	MPH
60	37.284
70	43.498
80	49.712
<i>etc. . . .</i>	

After thinking about this table of values, you decide that you will write a for loop that uses a counter variable to hold the kilometers-per-hour speeds. The counter's starting value will be 60, its ending value will be 130, and you will increase its value by 10 in the update expression. Inside the loop you will use the counter variable to calculate a speed in miles per hour.

The project, which is named *Speed Converter*, has already been started for you. It is located in the *Chap05* folder of this book's Student Sample Programs. The application's form is shown in Figure 5-14. The image on the left in the figure shows the names of the controls. The image on the right shows how the form appears after the user clicks the *Display Speeds* button.

**Figure 5-14** The *Speed Converter* form



**Step 1:** Start Visual Studio (or Visual Studio Express). Open the project named *Speed Converter* in the *Chap05* folder of this book's Student Sample Programs.

**Step 2:** Open the Form1 form in the *Designer*.

**Step 3:** In the *Designer*, double-click the `displayButton` control. This opens the code editor, and you will see an empty event handler named `displayButton_Click`. Complete the `displayButton_Click` event handler by typing the code shown in lines 22–41 in Program 5-3 (at the end of this tutorial). Let's take a closer look at the code:

**Lines 23–26:** These statements declare the following named constants:

- `START_SPEED`, an `int` constant set to 60. This is the starting speed for the list of conversions and the value with which the loop's counter variable is initialized.
- `END_SPEED`, an `int` constant set to 130. This is the ending speed for the list of conversions. When the counter variable exceeds this value, the loop stops.
- `INTERVAL`, an `int` constant set to 10. This is the amount that you add to loop's counter variable after each iteration.
- `CONVERSION_FACTOR`, a `double` constant set to 0.6214. This is the conversion factor that you use in the formula to convert KPH to MPH.

**Lines 29–30:** These statements declare the following variables:

- `kph`, an `int` variable to hold the speed in kilometers per hour.
- `mph`, a `double` variable to hold the speed in miles per hour.

**Line 33:** This is the beginning of a `for` loop that works in the following way:

**Initialization:** The `kph` variable is initialized with the value of `START_SPEED`, which is 60.

**Test:** The expression `kph <= END_SPEED` is tested at the beginning of each iteration.



**Update:** The expression `kph += INTERVAL` is executed at the end of each iteration. This adds the value of `INTERVAL` (which is 10) to the `kph` variable.

As the loop iterates, the `kph` variable is assigned the values 60, 70, 80, and so forth, through 130.

**Line 36:** This statement converts the value of the `kph` variable to miles per hour and assigns the result to the `mph` variable.

**Lines 39–40:** This statement adds a line to the `outputListBox` control showing the current value of the `kph` variable and the equivalent value in miles per hour.

**Step 4:** Switch your view back to the *Designer* and double-click the `exitButton` control. In the code editor you will see an empty event handler named `exitButton_Click`. Complete the `exitButton_Click` event handler by typing the code shown in lines 46–47 in Program 5-3.

**Step 5:** Save the project. Then, press `F5` on the keyboard or click the *Start Debugging* button (🐞) on the toolbar to compile and run the application. Click the *Display Speeds* button, and you should see the output shown in the image on the right in Figure 5-14. Click the *Exit* button to close the form.

---

### Program 5-3 Completed Form1 code for the *Speed Converter* application

```

1 using System;
2 using System.Collections.Generic;
3 using System.ComponentModel;
4 using System.Data;
5 using System.Drawing;
6 using System.Linq;
7 using System.Text;
8 using System.Threading.Tasks;
9 using System.Windows.Forms;
10
11 namespace Speed_Converter
12 {
13     public partial class Form1 : Form
14     {
15         public Form1()
16         {
17             InitializeComponent();
18         }
19
20         private void displayButton_Click(object sender, EventArgs e)
21         {
22             // Constants
23             const int START_SPEED = 60;
24             const int END_SPEED = 130;
25             const int INTERVAL = 10;
26             const double CONVERSION_FACTOR = 0.6214;
27
28             // Variables
29             int kph;           // Kilometers per hour
30             double mph;       // Miles per hour
31
32             // Display the table of speeds.
33             for (kph = START_SPEED; kph <= END_SPEED; kph += INTERVAL)
34             {

```

```

35         // Calculate miles per hour.
36         mph = kph * CONVERSION_FACTOR;
37
38         // Display the conversion.
39         outputListBox.Items.Add(kph + " KPH is the same as " +
40             mph + " MPH");
41     }
42 }
43
44 private void exitButton_Click(object sender, EventArgs e)
45 {
46     // Close the form.
47     this.Close();
48 }
49 }
50 }

```

## Checkpoint

- 5.11 Name the three expressions that appear inside the parentheses in the first line of a for loop.
- 5.12 You want to write a for loop that displays *I love to program* 50 times. Assume that you will use a variable named `count` as the counter variable.
- What initialization expression will you use?
  - What test expression will you use?
  - What update expression will you use?
  - Write the loop.
- 5.13 What would the following code display?
- ```

for (int count = 1; count <= 5; count++)
{
    MessageBox.Show(count.ToString());
}

```
- 5.14 What would the following code display?
- ```

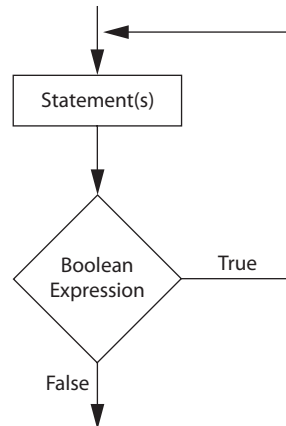
for (int count = 0; count <= 500; count += 100)
{
    MessageBox.Show(count.ToString());
}

```

## 5.5 The do-while Loop

**CONCEPT:** The **do-while** loop is a posttest loop, which means it performs an iteration before testing its Boolean expression.

You have learned that the `while` loop and the `for` are pretest loops, which means they test their Boolean expressions before performing an iteration. The `do-while` loop is a **posttest loop**. This means it performs an iteration before testing its Boolean expression. As a result, the `do-while` loop always performs at least one iteration, even if its Boolean expression is false to begin with. The logic of a `do-while` loop is shown in Figure 5-15.

**Figure 5-15** The logic of a `do-while` loop

In the flowchart, one or more statements are executed, and then a Boolean expression is tested. If the Boolean expression is true, the program's execution flows back to the point just above the first statement in the body of the loop, and this process repeats. If the Boolean expression is false, the program exits the loop.

In code, the `do-while` loop looks something like an inverted `while` loop. Here is the general format of the `do-while` loop:

```

do
{
    statement;
    statement;
    etc.
} while (BooleanExpression);
  
```

As with the `while` loop, the braces are optional if there is only one statement in the body of the loop. This is the general format of the `do-while` loop with only one conditionally executed statement:

```

do
    statement;
while (BooleanExpression);
  
```

Notice that a semicolon appears at the very end of the `do-while` statement. This semicolon is required; leaving it out is a common error.

The `do-while` loop is a *posttest* loop. This means it does not test its Boolean expression until it has completed an iteration. As a result, the `do-while` loop always performs at least one iteration, even if the expression is false to begin with. This differs from the behavior of a `while` loop. For example, in the following `while` loop, the statement that calls `MessageBox.Show` will not execute at all:

```

int number = 1;
while (number < 0)
{
    MessageBox.Show(number.ToString());
}
  
```

But, the statement that calls `MessageBox.Show` in the following `do-while` loop executes one time because the `do-while` loop does not test the expression `number < 0` until the end of the iteration.

```

int number = 1;
do
  
```

```

{
    MessageBox.Show(number.ToString());
} while (number < 0);

```



## Checkpoint

- 5.15 What is a posttest loop?
- 5.16 What is the difference between the `while` loop and the `do-while` loop?
- 5.17 How many times will the following loop iterate?

```

int count = 0;
do
{
    MessageBox.Show(count.ToString());
    count++;
} while (count < 0);

```

## 5.6 Using Files for Data Storage

**CONCEPT:** When a program needs to save data for later use, it writes the data in a file. The data can be read from the file at a later time.

The programs you have written so far require the user to reenter data each time the program runs because data kept in variables and control properties is stored in RAM and disappears once the program stops running. If a program is to retain data between the times it runs, it must have a way of saving it. Data is saved in a file, which is usually stored on a computer's disk. Once the data is saved in a file, it will remain there after the program stops running. Data that is stored in a file can be retrieved and used at a later time.

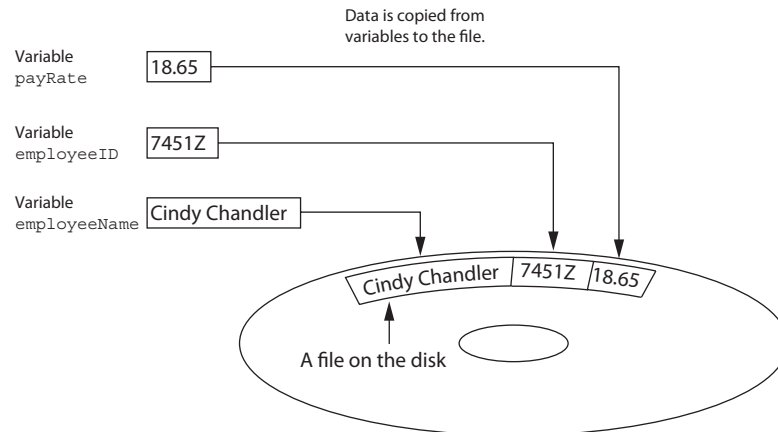
Most of the commercial software that you use on a day-to-day basis store data in files. The following are a few examples.

- **Word processors:** Word processing programs are used to write letters, memos, reports, and other documents. The documents are then saved in files so they can be edited and printed.
- **Image editors:** Image-editing programs are used to draw graphics and edit images, such as the ones that you take with a digital camera. The images that you create or edit with an image editor are saved in files.
- **Spreadsheets:** Spreadsheet programs are used to work with numerical data. Numbers and mathematical formulas can be inserted into the rows and columns of the spreadsheet. The spreadsheet can then be saved in a file for use later.
- **Games:** Many computer games keep data stored in files. For example, some games keep a list of player names with their scores stored in a file. These games typically display the players' names in order of their scores, from highest to lowest. Some games also allow you to save your current game status in a file so you can quit the game and then resume playing it later without having to start from the beginning.
- **Web browsers:** Sometimes when you visit a Web page, the browser stores a small file known as a *cookie* on your computer. Cookies typically contain information about the browsing session, such as the contents of a shopping cart.

Programs that are used in daily business operations rely extensively on files. Payroll programs keep employee data in files, inventory programs keep data about a company's products in files, accounting systems keep data about a company's financial operations in files, and so on.

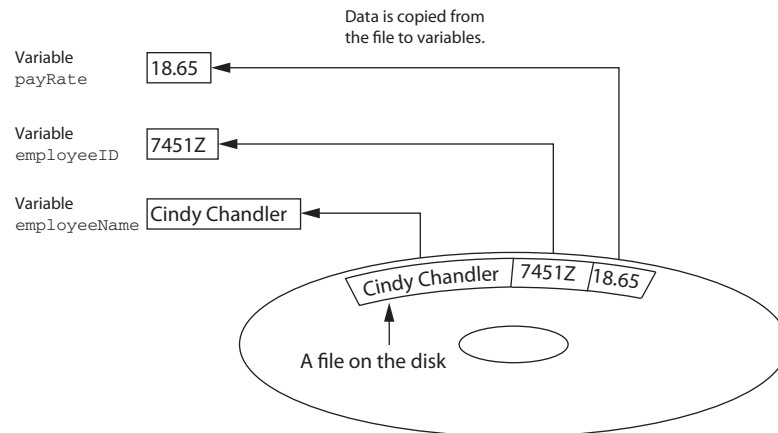
Programmers usually refer to the process of saving data in a file as *writing data* to the file. When a piece of data is written to a file, it is copied from a variable in RAM to the file. This is illustrated in Figure 5-16. The term **output file** is used to describe a file to which data is written. It is called an output file because the program stores output in it.

**Figure 5-16** Writing data to a file



The process of retrieving data from a file is known as *reading data* from the file. When a piece of data is read from a file, it is copied from the file into a variable in RAM. Figure 5-17 illustrates this. The term **input file** is used to describe a file from which data is read. It is called an input file because the program gets input from the file.

**Figure 5-17** Reading data from a file



In this section we discuss ways to create programs that write data to files and read data from files. There are always three steps that must be taken when a file is used by a program.

1. **Open the file**—Opening a file creates a connection between the file and the program. Opening an output file usually creates the file on the disk and allows the program to write data to it. Opening an input file allows the program to read data from the file.
2. **Process the file**—In this step data is either written to the file (if it is an output file) or read from the file (if it is an input file).
3. **Close the file**—When the program is finished using the file, the file must be closed. Closing a file disconnects the file from the program.

## Types of Files

In general, there are two types of files: text and binary. A **text file** contains data that has been encoded as text using a scheme such as Unicode. Even if the file contains numbers, those numbers are stored in the file as a series of characters. As a result, the file may be opened and viewed in a text editor such as Notepad. A **binary file** contains data that has not been converted to text. As a consequence, you cannot view the contents of a binary file with a text editor. In this chapter we work only with text files.

## File Access Methods

Most programming languages provide two different ways to access data stored in a file: sequential access and direct access. When you work with a **sequential access file**, you access data from the beginning of the file to the end of the file. If you want to read a piece of data that is stored at the very end of the file, you have to read all the data that comes before it—you cannot jump directly to the desired data. This is similar to the way cassette tape players work. If you want to listen to the last song on a cassette tape, you have to either fast-forward over all of the songs that come before it or listen to them. There is no way to jump directly to a specific song.

When you work with a **direct access file** (which is also known as a **random access file**), you can jump directly to any piece of data in the file without reading the data that comes before it. This is similar to the way a CD player or an MP3 player works. You can jump directly to any song you want to listen to.

This chapter focuses on sequential access files. Sequential access files are easy to work with, and you can use them to gain an understanding of basic file operations.

## Filenames and File Objects

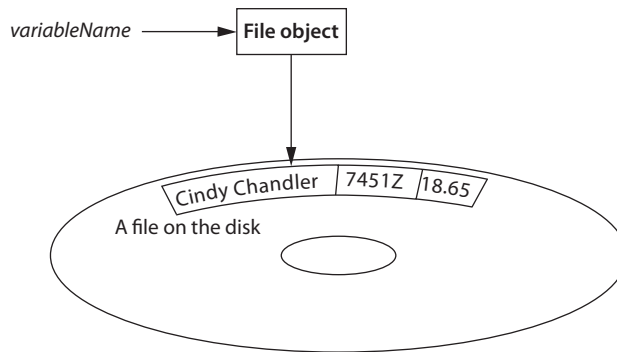
Files on a disk are identified by a **filename**. For example, when you create a document with a word processor and then save the document in a file, you have to specify a filename. When you use a utility such as Windows Explorer to examine the contents of your disk, you see a list of filenames. Figure 5-18 shows how three files named `cat.jpg`, `notes.txt`, and `resume.doc` might be represented in Windows Explorer.

**Figure 5-18** Three files



Each operating system has its own rules for naming files. Many systems, including Windows, support the use of **filename extensions**, which are short sequences of characters that appear at the end of a filename and are preceded by a period (which is known as a “dot”). For example, the files depicted in Figure 5-18 have the extensions `.jpg`, `.txt`, and `.doc`. The extension usually indicates the type of data stored in the file. For example, the `.jpg` extension usually indicates that the file contains a graphic image that is compressed according to the JPEG image standard. The `.txt` extension usually indicates that the file contains text. The `.doc` extension usually indicates that the file contains a Microsoft Word document.

In order for a program to work with a file on the computer’s disk, the program must create a file object in memory. A **file object** is an object that is associated with a specific file and provides a way for the program to work with that file. In the program, a variable is linked with the file object. We say that the variable *references* the object. This variable is used to carry out any operations that are performed on the file. This concept is shown in Figure 5-19.

**Figure 5-19** A variable referencing a file object that is associated with a file

You will be using two classes from the .NET Framework to create file objects. When you want to write data to a text file, you use the **StreamWriter** class, and when you want to read data from a text file you use the **StreamReader** class. These classes are in the `System.IO` namespace in the .NET Framework, so you will need to write the following directive at the top of your programs:

```
using System.IO;
```



**NOTE:** In programming terminology, files are considered streams of data. In C# you use a `StreamWriter` object to open a stream, such as a file, and write data to it. You use a `StreamReader` object to open a stream, such as a file, and read data from it.

## Writing Data to a File with a StreamWriter Object

You can use the `StreamWriter` class's **WriteLine** method to write a line of text to a file. Let's suppose you want to write a program that creates a text file named `courses.txt` and writes the names of the courses you are taking to the file. The following code sample shows how you can do this:

```
1 StreamWriter outputFile;
2 outputFile = File.CreateText("courses.txt");
3
4 outputFile.WriteLine("Intro to Computer Science");
5 outputFile.WriteLine("English Composition");
6 outputFile.WriteLine("Calculus I");
7 outputFile.WriteLine("Music Appreciation");
8
9 outputFile.Close();
```

Let's look at each line of code.

**Line 1:** This statement declares a variable named `outputFile`, which can be used to reference a `StreamWriter` object.

**Line 2:** In a nutshell, this statement opens the file to which you will be writing data. It does so by calling the `File.CreateText` method, passing the string `"courses.txt"` as an argument. The `File.CreateText` method does the following:

- It creates a text file with the name specified by the argument. If the file already exists, its contents are erased.
- It creates a `StreamWriter` object in memory, associated with the file.
- It returns a reference to the `StreamWriter` object.

Notice that an assignment operator assigns the value returned from the `File.CreateText` method to the `outputFile` variable. This causes the `outputFile` variable to reference the `StreamWriter` object that was created by the method.

After the statement in line 2 executes, the `courses.txt` file is created on the disk, a `StreamWriter` object associated with the file exists in memory, and the `outputFile` variable references that object.

**Line 4:** This statement writes the string "Intro to Computer Science" to the `courses.txt` file. It does that by calling the `StreamWriter` class's `WriteLine` method, passing the string that is to be written to the file as an argument. When the `WriteLine` method writes data to a file, it writes a newline character immediately following the data. A **newline character** is an invisible character that specifies the end of a line of text.

**Line 5:** This statement writes the string "English Composition" to the `courses.txt` file.

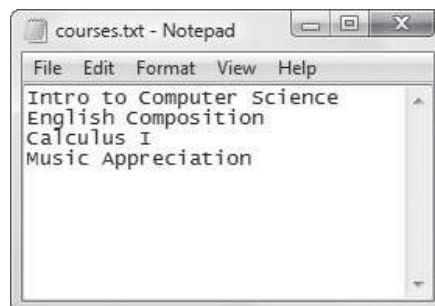
**Line 6:** This statement writes the string "Calculus I" to the `courses.txt` file.

**Line 7:** This statement writes the string "Music Appreciation" to the `courses.txt` file.

**Line 9:** This statement closes the `courses.txt` file. It does that by calling the `StreamWriter` class's `Close` method.

After this code has executed, we can open the `courses.txt` file using a text editor and look at its contents. Figure 5-20 shows how the file's contents will appear in Notepad.

**Figure 5-20** Contents of the `courses.txt` file shown in Notepad

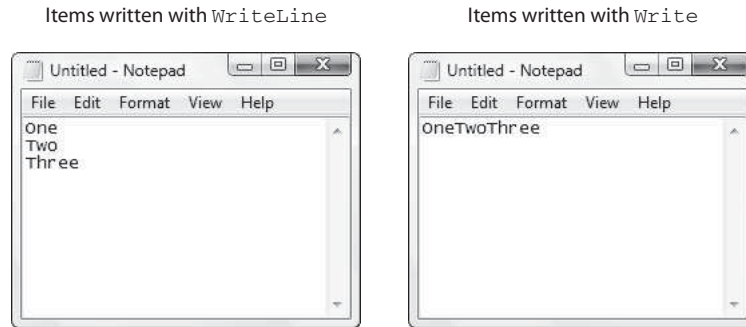


## Writing Data with the `write` Method

Earlier you read that the `StreamWriter` class's `WriteLine` method writes an item of data to a file and then writes a newline character. The newline character specifies the end of a line of text. For example, the following code sample opens a file named `Example.txt` and then uses the `WriteLine` method to write the strings "One", "Two", and "Three" to the file. Because a newline character is written after each string, the strings appear on separate lines when viewed in a text editor. The screen shown on the left in Figure 5-21 shows how the file would appear in Notepad.

```
1 StreamWriter outputFile;  
2 outputFile = File.CreateText("Example.txt");  
3  
4 outputFile.WriteLine("One");  
5 outputFile.WriteLine("Two");  
6 outputFile.WriteLine("Three");  
7  
8 outputFile.Close();
```



**Figure 5-21** Items written with the `WriteLine` and `Write` methods

In some situations you might want to write an item to a file without a newline character immediately following it. The `StreamWriter` class provides the **Write method** for this purpose. It writes an item of data to a text file without writing a newline character. The following code sample demonstrates. The screen shown on the right in Figure 5-21 shows how the resulting file would appear in Notepad.

```

1 StreamWriter outputFile;
2 outputFile = File.CreateText("Example.txt");
3
4 outputFile.Write("One");
5 outputFile.Write("Two");
6 outputFile.Write("Three");
7
8 outputFile.Close();

```

## Handling File-Related Exceptions

Unexpected problems can potentially occur when working with files. For example, your program might not have sufficient rights to create a file when it calls the `File.CreateText` method, or the disk might be full when you call the `StreamWriter` class's `WriteLine` method. When unexpected errors such as these occur, an exception is thrown. To handle such exceptions, you can write a `try-catch` statement, with the code that performs file operations placed in the `try` block. Here is an example:

```

1 try
2 {
3     StreamWriter outputFile;
4     outputFile = File.CreateText("courses.txt");
5
6     outputFile.WriteLine("Intro to Computer Science");
7     outputFile.WriteLine("English Composition");
8     outputFile.WriteLine("Calculus I");
9     outputFile.WriteLine("Music Appreciation");
10
11     outputFile.Close();
12 }
13 catch (Exception ex)
14 {
15     // Display an error message.
16     MessageBox.Show(ex.Message);
17 }

```

In Tutorial 5-4 you will complete an application that reads input from a `TextBox` control and writes the input to a file.



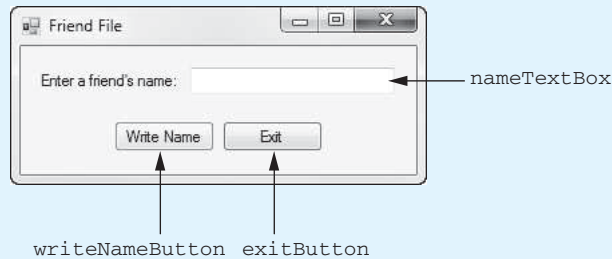
**Tutorial 5-4:**  
Writing  
Data to a  
Text File



## Tutorial 5-4: Writing Data to a Text File

In this tutorial you complete the *Friend File* application. The project has already been started for you and is located in the *Chap05* folder of this book's Student Sample Programs. The application's form is shown in Figure 5-22.

**Figure 5-22** The *Friend File* form



When you complete the application, it will allow the user to enter a name into the `nameTextBox` control. When the user clicks the `writeNameButton` control, the application opens a text file named `Friend.txt`, writes the name that was entered into the `TextBox` control to the file, and then closes the file.

- Step 1:** Start Visual Studio (or Visual Studio Express). Open the project named *Ending Balance* in the *Chap05* folder of this book's Student Sample Programs.
- Step 2:** Open the `Form1` form's code in the code editor. Insert the `using System.IO;` directive shown in line 10 of Program 5-4 at the end of this tutorial. This statement is necessary because the `StreamWriter` class is part of the `System.IO` namespace in the .NET Framework.
- Step 3:** Open the `Form1` form in the *Designer*. The form is shown, along with the names of the important controls, in Figure 5-22. Double-click the `writeNameButton` control. This opens the code editor, and you will see an empty event handler named `writeNameButton_Click`. Complete the `writeNameButton_Click` event handler by typing the code shown in lines 23–44 in Program 5-4. Let's take a closer look at the code:

**Line 23:** This is the beginning of a `try-catch` statement. The `try` block appears in lines 25–38, and the `catch` block appears in lines 42–43. If an exception is thrown by any statement in the `try` block, the program jumps to the `catch` block, and line 43 displays an error message.

**Line 26:** This statement declares a `StreamWriter` variable named `outputFile`. You use this variable to reference a `StreamWriter` object.

**Line 29:** This statement calls the `File.CreateText` method to create a text file named `Friend.txt`. The method also creates a `StreamWriter` object in memory associated with the file. The method returns a reference to that object, which is assigned to the `outputFile` variable. As a result, the `outputFile` variable references the `StreamWriter` object. You will be able to use the `outputFile` variable to perform operations on the `Friend.txt` file.

**Line 32:** This statement uses the `outputFile` variable to call the `StreamWriter` class's `writeLine` method. The `nameTextBox` control's `Text` property is passed as an argument. As a result, the value entered into the `TextBox` is written to the `Friend.txt` file.

**Line 35:** This statement closes the Friend.txt file.

**Line 38:** This statement displays a message box to let the user know that the name was written to the file.

**Step 4:** Switch your view back to the *Designer* and double-click the `exitButton` control. In the code editor you will see an empty event handler named `exitButton_Click`. Complete the `exitButton_Click` event handler by typing the code shown in lines 49–50 in Program 5-4.

**Step 5:** Save the project. Then, press **F5** on the keyboard or click the *Start Debugging* button (▶) on the toolbar to compile and run the application.

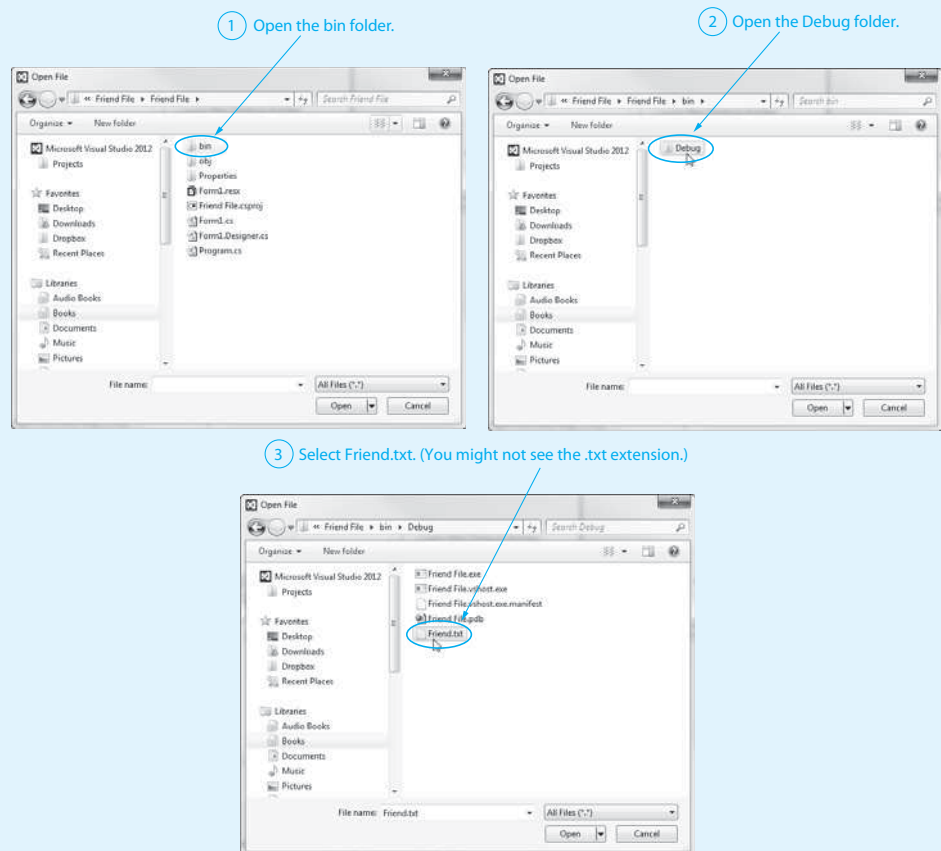
Enter a name into the `nameTextBox` control, and then click the *Write Name* button. You should see a message box appear letting you know that the name was written to the file. Click the *OK* button to dismiss the message box; then click the *Exit* button on the application’s form to end the application.

**Step 6:** Now you will look at the contents of the `Friend.txt` file that the application created. Perform one of the following, depending on whether you are using Visual Studio or Visual Studio Express:

- If you are using Visual Studio, click *FILE* on the menu bar, then click *Open*, and then click *File*.
- If you are using Visual Studio Express, click *FILE* on the menu bar, and then click *Open File*.

**Step 7:** You should now see the *Open File* window, viewing the contents of the *Friend File* project folder. As shown in Figure 5-23, open the *bin* folder, then open the

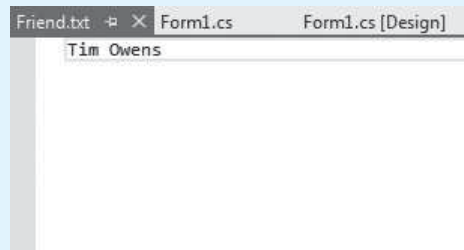
**Figure 5-23** Opening the `Friend.txt` file in the *Open File* window



*Debug* folder, and then select the file *Friend.txt*. (You might not see the .txt extension, depending on how your system is set up.) Click the *Open* button.

**Step 8:** You should now see the contents of the *Friend.txt* file in Visual Studio, as shown in Figure 5-24. (The example in the figure shows the contents of the file after the user has written *Tim Owens* to the file.) When you are finished examining the contents of the file, you can close its tab. We come back to this project in the next tutorial.

**Figure 5-24** Sample contents of the *Friend.txt* file shown in Visual Studio



**Program 5-4** Completed *Form1* code for the *Friend File* application

```

1 using System;
2 using System.Collections.Generic;
3 using System.ComponentModel;
4 using System.Data;
5 using System.Drawing;
6 using System.Linq;
7 using System.Text;
8 using System.Threading.Tasks;
9 using System.Windows.Forms;
10 using System.IO;
11
12 namespace Friend_File
13 {
14     public partial class Form1 : Form
15     {
16         public Form1()
17         {
18             InitializeComponent();
19         }
20
21         private void writeNameButton_Click(object sender, EventArgs e)
22         {
23             try
24             {
25                 // Declare a StreamWriter variable.
26                 StreamWriter outputFile;
27
28                 // Create a file and get a StreamWriter object.
29                 outputFile = File.CreateText("Friend.txt");
30
31                 // Write the friend's name to the file.
32                 outputFile.WriteLine(nameTextBox.Text);
33
34                 // Close the file.
35                 outputFile.Close();

```

```

36
37         // Let the user know the name was written.
38         MessageBox.Show("The name was written.");
39     }
40     catch (Exception ex)
41     {
42         // Display an error message.
43         MessageBox.Show(ex.Message);
44     }
45 }
46
47 private void exitButton_Click(object sender, EventArgs e)
48 {
49     // Close the form.
50     this.Close();
51 }
52 }
53 }

```

## Writing Numeric Data to a Text File

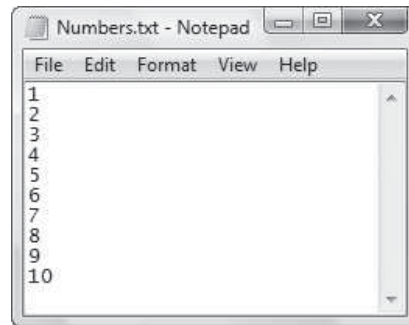
You can use the `StreamWriter` class's `WriteLine` or `Write` method to write numbers (such as ints, doubles, and decimals) to a text file, but the numbers are converted to strings. For example, look at the following sample code (taken from the *Number File* project in the *Chap05* folder of the Student Sample Programs):

```

1 private void writeNumbersButton_Click(object sender, EventArgs e)
2 {
3     try
4     {
5         // Declare a StreamWriter variable.
6         StreamWriter outputFile;
7
8         // Create a file and get a StreamWriter object.
9         outputFile = File.CreateText("Numbers.txt");
10
11        // Write the numbers 1 through 10 to the file.
12        for (int count = 1; count <= 10; count++)
13        {
14            outputFile.WriteLine(count);
15        }
16
17        // Close the file.
18        outputFile.Close();
19    }
20    catch (Exception ex)
21    {
22        // Display an error message.
23        MessageBox.Show(ex.Message);
24    }
25 }

```

When this event handler executes, line 9 creates a text file named `Numbers.txt`, and the loop in lines 12–15 writes the numbers 1–10 to the file. Figure 5-25 shows how the file appears when opened with Notepad.

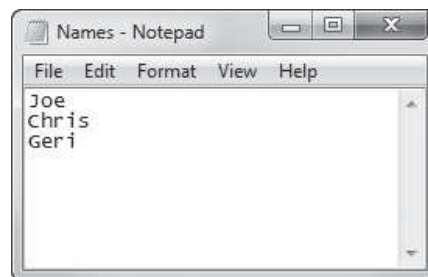
**Figure 5-25** The Numbers.txt file opened in Notepad

## Appending Data to an Existing File

When you call the `File.CreateText` method to open a file and the file specified by the argument already exists, it is erased and a new empty file with the same name is created. For example, when you run the *Friend File* application that you completed in Tutorial 5-4, each time you click the *Write Name* button, the `Friend.txt` file is erased and a new file is created.

Sometimes you want to preserve an existing file and append new data to its current contents. To append data to an existing file, you open it with the `File.AppendText` method. It works like the `File.CreateText` method, but the file is not erased if it already exists. Any data written to the file is appended to the file's existing contents.

For example, assume the file `Names.txt` exists and contains the data shown in Figure 5-26:

**Figure 5-26** Names.txt file

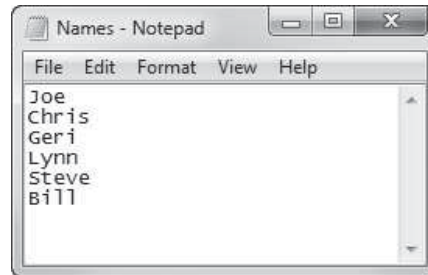
The following code opens the file and appends additional data to its existing contents:

```

1 StreamWriter outputFile;
2 outputFile = File.AppendText("Names.txt");
3
4 outputFile.WriteLine("Lynn");
5 outputFile.WriteLine("Steve");
6 outputFile.WriteLine("Bill");
7
8 outputFile.Close();

```

After this code executes, the `Names.txt` file contains the data shown in Figure 5-27:

**Figure 5-27** Names.txt file after data has been appended

VideoNote

**Tutorial 5-5:**  
Appending  
Data to the  
Friend.txt  
File



### Tutorial 5-5: Appending Data to the Friend.txt File

In this tutorial you will modify the *Friend File* application so it appends data to the Friend.txt file. When the user clicks the *Write Name* button, instead of erasing the file's current contents, the application adds the contents of the `nameTextBox` control to the Friend.txt file.

**Step 1:** If the *Friend File* project from Tutorial 5-4 is not currently open in Visual Studio (or Visual Studio Express), open it now.

**Step 2:** Open the Form1 form's code in the code editor. You will make modifications to the `writeNameButton_Click` event handler. Program 5-5, at the end of this tutorial, shows how the event handler code will appear after you make the following changes:

**Lines 8 and 9:** Change the comments as shown to reflect the way that the Friend.txt file will be opened in line 10.

**Line 10:** Change this statement so it calls the `File.AppendText` method instead of the `File.CreateText` method.

**Lines 21–25:** Add the new comments and statements shown in these lines. Line 22 clears the `nameTextBox` control's contents, and line 25 gives the focus to the `nameTextBox` control. This makes the application more convenient for adding several names to the file.

**Step 3:** Save the project. Then, press **F5** on the keyboard or click the *Start Debugging* button (🐞) on the toolbar to compile and run the application.

Enter a name into the `nameTextBox` control and then click the *Write Name* button. You should see a message box letting you know that the name was written to the file. When you click the *OK* button to dismiss the message box, notice that the `nameTextBox` is cleared, and the focus is given to the `TextBox`. Enter another name, and click the *Write Name* button. Again, you see the message box. Click the *OK* button to dismiss the message box and then click the *Exit* button to end the application.

**Step 4:** Now you will look at the contents of the Friend.txt file.

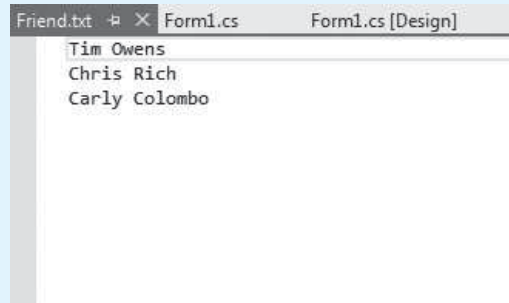
- If you are using Visual Studio, click *FILE* on the menu bar, then click *Open*, and then click *File*.
- If you are using Visual Studio Express, click *FILE* on the menu bar and then click *Open File*.

You should now see the *Open File* window, viewing the contents of the *Friend File* project folder. Open the *bin* folder, then open the *Debug* folder, and then

select the file *Friend.txt*. (You might not see the .txt extension, depending on how your system is set up.) Click the *Open* button.

**Step 5:** You should now see the contents of the *Friend.txt* file in Visual Studio. Figure 5-28 shows an example. Notice that the names that you entered were appended to the file each time you clicked the *Write Name* button. When you are finished examining the contents of the file, you can close its tab. We come back to this project in the next tutorial.

**Figure 5-28** Sample contents of the *Friend.txt* file shown in Visual Studio



**Program 5-5** Partial code for *Form1* in the *Friend File* application

```

1 private void writeNameButton_Click(object sender, EventArgs e)
2 {
3     try
4     {
5         // Declare a StreamWriter variable.
6         StreamWriter outputFile;
7
8         // Open the Friend.txt file for appending,
9         // and get a StreamWriter object.
10        outputFile = File.AppendText("Friend.txt");
11
12        // Write the friend's name to the file.
13        outputFile.WriteLine(nameTextBox.Text);
14
15        // Close the file.
16        outputFile.Close();
17
18        // Let the user know the name was written.
19        MessageBox.Show("The name was written.");
20
21        // Clear the nameTextBox control.
22        nameTextBox.Text = "";
23
24        // Give the focus to the nameTextBox control.
25        nameTextBox.Focus();
26    }
27    catch (Exception ex)
28    {
29        // Display an error message.
30        MessageBox.Show(ex.Message);
31    }
32 }

```



## Specifying the Location of an Output File

When you call the `File.CreateText` or `File.AppendText` methods to open a file, you pass the filename as a string argument. If the filename that you pass as an argument does not contain the file's path, the file's location will be the *bin\Debug* folder, under the application's project folder. You saw this in Tutorials 5-4 and 5-5 when you opened the `Friend.txt` file in Visual Studio.

If you want to open a file in a different location, you can specify a path as well as a filename in the argument that you pass to the `File.CreateText` or `File.AppendText` method. If you specify a path in a string literal, be sure to prefix the string with the `@` character. Here is an example:

```
StreamWriter outputFile;
outputFile = File.CreateText(@"C:\Users\Chris\Documents\Names.txt");
```

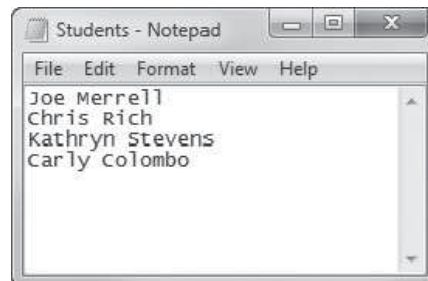


**TIP:** You can also let the user specify the file location. See Section 5.7 for more information on the `SaveFileDialog` control.

## Reading Data from a File with a StreamReader Object

To read data from a text file, you create a `StreamReader` object. You can then use the `StreamReader` class's **`ReadLine`** method to read a line of text from a file. For example, suppose a file named `Students.txt` exists and contains the four names shown in Figure 5-29.

**Figure 5-29** Contents of the `Students.txt` file



Let's suppose you want to write a program that reads the four names from the `Students.txt` file and displays them in message boxes. The following code sample shows how you can do this. (This code sample is taken from the *Student Names* project, in the *Chap05* folder of this book's Student Sample Programs.)

```
1 try
2 {
3     // Declare a variable to hold an item read from the file.
4     string studentName;
5
6     // Declare a StreamReader variable.
7     StreamReader inputFile;
8
9     // Open the file and get a StreamReader object.
10    inputFile = File.OpenText("Students.txt");
11
```

```

12     // Read and display the first name.
13     studentName = inputFile.ReadLine();
14     MessageBox.Show(studentName);
15
16     // Read and display the second name.
17     studentName = inputFile.ReadLine();
18     MessageBox.Show(studentName);
19
20     // Read and display the third name.
21     studentName = inputFile.ReadLine();
22     MessageBox.Show(studentName);
23
24     // Read and display the fourth name.
25     studentName = inputFile.ReadLine();
26     MessageBox.Show(studentName);
27
28     // Close the file.
29     inputFile.Close();
30 }
31 catch (Exception ex)
32 {
33     // Display an error message.
34     MessageBox.Show(ex.Message);
35 }

```

Let's take a closer look at the code.

**Line 1:** This is the beginning of a `try-catch` statement. An exception will be thrown in the `try` block if a problem occurs while the file is being opened or while an item is being read from the file. If that happens, the program jumps to the `catch` clause in line 31.

**Line 4:** This statement declares a `string` variable named `studentName`. Each time we read a line of text from the file, we assign it to this variable.

**Line 7:** This statement declares a variable named `inputFile` that can be used to reference a `StreamReader` object.

**Line 10:** This statement opens the file from which we will be reading data. It does so by calling the `File.OpenText` method, passing the string `"Students.txt"` as an argument. The `File.OpenText` method does the following:

- It opens an existing text file with the name specified by the argument. If the file does not exist, an exception is thrown.
- It creates a `StreamReader` object in memory associated with the file.
- It returns a reference to the `StreamReader` object.

Notice that an assignment operator assigns the value returned from the `File.OpenText` method to the `inputFile` variable. This causes the `inputFile` variable to reference the `StreamReader` object that was created by the method.

**Line 13:** This statement calls the `inputFile.ReadLine` method, which reads a line of text from the file. The line of text is returned as a `string` from the method and assigned to the `studentName` variable. Since this statement reads the first line of text from the file, the `studentName` variable is assigned the string `"Joe Merrell"`.

**Line 14:** This statement displays the contents of the `studentName` variable in a message box.

**Lines 17 and 18:** The statement in line 17 reads the next line of text from the file and assigns it to the `studentName` variable. After this line executes, the `studentName` variable is assigned the string `"Chris Rich"`. The statement in line 18 displays the contents of the `studentName` variable in a message box.

**Lines 21 and 22:** The statement in line 21 reads the next line of text from the file and assigns it to the `studentName` variable. After this line executes, the `studentName` variable is assigned the string `"Kathryn Stevens"`. The statement in line 22 displays the contents of the `studentName` variable in a message box.

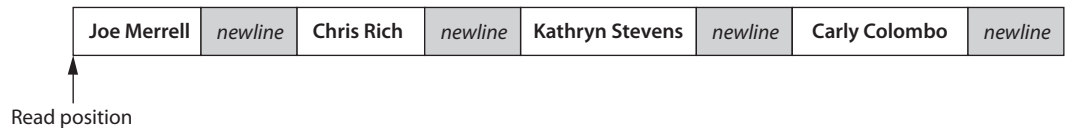
**Lines 25 and 26:** The statement in line 25 reads the next line of text from the file and assigns it to the `studentName` variable. After this line executes, the `studentName` variable is assigned the string `"Carly Colombo"`. The statement in line 26 displays the contents of the `studentName` variable in a message box.

**Line 29:** This statement closes the `Students.txt` file.

## The Read Position

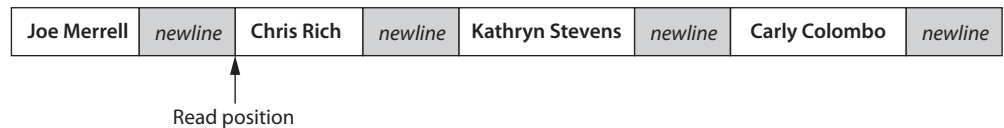
When a program works with an input file, a special value known as a **read position** is internally maintained for that file. A file's read position marks the location of the next item that will be read from the file. When an input file is opened, its read position is initially set to the first item in the file. As items are read from the file, the read position moves forward, toward the end of the file. Let's see how this works in the previous code sample (from the *Student Names* project) After the statement in line 10 executes, the read position for the `Students.txt` file is positioned as shown in Figure 5-30.

**Figure 5-30** The initial read position



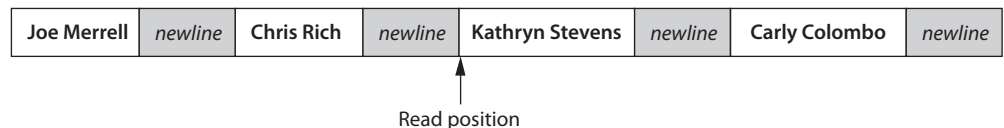
The `readLine` method call in line 13 reads an item from the file's current read position and assigns that item to the `studentName` variable. Once this statement executes, the `studentName` variable is assigned the string `"Joe Merrell"`. In addition, the file's read position is advanced to the next item in the file, as shown in Figure 5-31.

**Figure 5-31** Read position after the first `readLine` method call



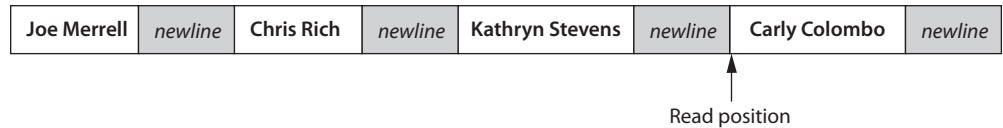
The `readLine` method call in line 17 reads an item from the file's current read position and assigns that value to the `studentName` variable. Once this statement executes, the `studentName` variable is assigned the string `"Chris Rich"`. The file's read position is advanced to the next item, as shown in Figure 5-32.

**Figure 5-32** Read position after the second `readLine` method call



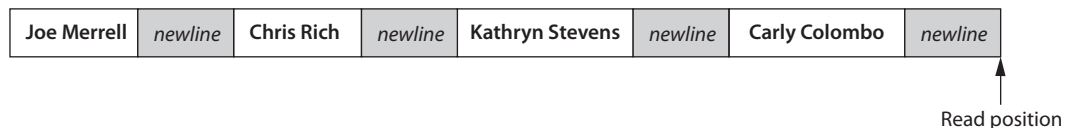
The `ReadLine` method call in line 21 reads an item from the file's current read position and assigns that value to the `studentName` variable. Once this statement executes, the `studentName` variable is assigned the string "Kathryn Stevens". The file's read position is advanced to the next item, as shown in Figure 5-33.

**Figure 5-33** Read position after the third `ReadLine` method call



The last `ReadLine` method call appears in line 25. It reads an item from the file's current read position and assigns that value to the `studentName` variable. Once this statement executes, the `studentName` variable is assigned the string "Carly Colombo". The file's read position is advanced to the end of the file, as shown in Figure 5-34.

**Figure 5-34** Read position after the fourth `ReadLine` method call



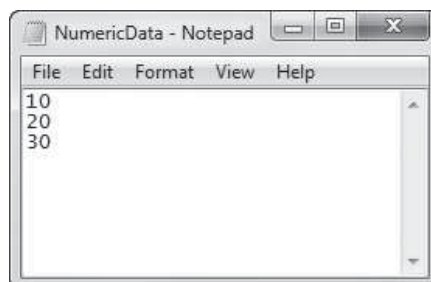
**NOTE:** Did you notice that the previous code sample read the items in the `Students.txt` file in sequence, from the beginning of the file to the end of the file? Recall from our discussion at the beginning of the section that this is the nature of a sequential access file.

## Reading Numeric Data from a Text File

Remember that when data is stored in a text file, it is encoded as text, using a scheme such as Unicode. Even if the file contains numbers, those numbers are stored in the file as a series of characters. Furthermore, when you read an item from a text file with the `StreamReader` class's `ReadLine` method, that item is returned as a string.

Suppose a text file contains numeric data, such as that shown in Figure 5-35. When we use the `ReadLine` method to read the items from the file, we get the strings "10", "20", and "30". If we need to perform math with these values, we must convert each value from a string to a numeric data type. We can use the `Parse` or `TryParse` families of methods that you already know about to perform this conversion.

**Figure 5-35** A text file containing numeric data



Let's suppose you want to write a program that reads the three numbers from the `NumericData.txt` file shown in Figure 5-35 and displays their total in a message box. The following code sample shows a simple demonstration. (This code sample is taken from the *Numeric Data* project in the *Chap05* folder of this book's Student Sample Programs.)

```

1 try
2 {
3     // Variables to hold the numbers read from the file
4     // and their total
5     int number1, number2, number3, total;
6
7     // A StreamReader variable.
8     StreamReader inputFile;
9
10    // Open the file and get a StreamReader object.
11    inputFile = File.OpenText("NumericData.txt");
12
13    // Read three numbers from the file.
14    number1 = int.Parse(inputFile.ReadLine());
15    number2 = int.Parse(inputFile.ReadLine());
16    number3 = int.Parse(inputFile.ReadLine());
17
18    // Calculate the total of the numbers.
19    total = number1 + number2 + number3;
20
21    // Display the total.
22    MessageBox.Show("The total is " + total);
23
24    // Close the file.
25    inputFile.Close();
26 }
27 catch (Exception ex)
28 {
29     // Display an error message.
30     MessageBox.Show(ex.Message);
31 }

```

Let's take a closer look at the code.

**Line 1:** This is the beginning of a `try-catch` statement. Various exceptions can be thrown by the code in the `try` block, which cause the program to jump to the `catch` clause in line 27.

**Line 5:** This statement declares the `int` variables `number1`, `number2`, `number3`, and `total`. These variables hold the three values read from the file and their total.

**Lines 8–11:** After these statements have executed, the `NumericData.txt` file is opened for reading, and the `inputFile` variable references a `StreamReader` object that is associated with the file.

**Line 14:** This statement does the following:

- It calls the `inputFile.ReadLine` method to read a line of text from the file.
- The value that is returned from the `inputFile.ReadLine` method (a string) is passed as an argument to the `int.Parse` method.
- The value that is returned from the `int.Parse` method is assigned to the `number1` variable.

After this statement executes, the `number1` variable is assigned the first value read from the file, converted to an `int`. (The `number1` variable is assigned the value 10.)

**Line 15:** This statement reads the next value from the file, converts it to an `int`, and assigns the result to the `number2` variable. (The `number2` variable is assigned the value 20.)

**Line 16:** This statement reads the next value from the file, converts it to an `int`, and assigns the result to the `number3` variable. (The `number3` variable is assigned the value 30.)

**Line 19:** This statement calculates the sum of `number1`, `number2`, and `number3`, and assigns the result to `total`.

**Line 22:** This statement displays the sum of the numbers in a message box.

**Line 25:** This statement closes the file.

## Reading a File with a Loop and Detecting the End of the File

Quite often a program must read the contents of a file without knowing the number of items that are stored in the file. For example, suppose you need to write a program that displays all the items in a file, but you do not know how many items the file contains. You can open the file and then use a loop to repeatedly read an item from the file and display it. However, an exception will be thrown if the program attempts to read beyond the end of the file. The program needs some way of knowing when the end of the file has been reached so it will not try to read beyond it. The following pseudocode shows the logic:

```
Open the file
While not at the end of the file:
    Read an item from the file
    Display the item
End While
Close the file
```

`StreamReader` objects have a Boolean property named `EndOfStream` that signals whether the end of the file has been reached. If the file's read position is at the end of the file (and there is no more data to read), the `EndOfStream` property is set to `true`. Otherwise, it is set to `false`. When you need to read all the items in a file without knowing how many items the file contains, you can write a loop that iterates as long as the `EndOfStream` property is `false`.

Let's assume `inputFile` references a `StreamReader` object that is associated with a file that is already open. You can write the loop in the following manner:

```
while (inputFile.EndOfStream == false)
{
    // Read an item from the file.
    // Process the item.
}
```

However, most programmers prefer the following logic, which uses the `!` operator:

```
while (!inputFile.EndOfStream)
{
    // Read an item from the file.
    // Process the item.
}
```

Recall that the `!` operator is the logical NOT operator. When you read the first line of this loop, you naturally think *while NOT at the end of the stream*. In Tutorial 5-6 you will complete an application that uses this technique to display all the items in a file.



## Tutorial 5-6: Using a Loop to Read to the End of a File

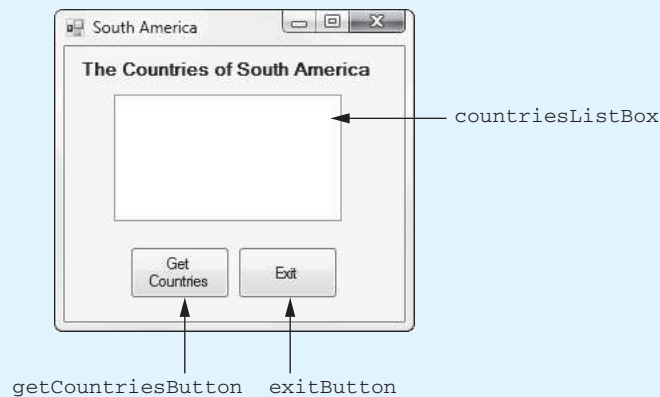


VideoNote

**Tutorial 5-6:**  
Using a  
Loop to  
Read to the  
End of a File

In this tutorial you complete the *South America* application that is found in the *Chap05* folder of this book's Student Sample Programs. The application's form has already been created and is shown in Figure 5-36. The application also has an accompanying text file named *Countries.txt* that is stored in the *bin\Debug* folder under the project folder. The *Countries.txt* file contains the names of the countries of South America. Figure 5-37 shows the file as it appears in Notepad.

**Figure 5-36** The *South America* application's form



**Figure 5-37** The *Countries.txt* file



When the completed application runs and the user clicks the *Get Countries* button, the application reads each country name from the file and adds each one to the `countriesListBox` control.

**Step 1:** Start Visual Studio (or Visual Studio Express). Open the project named *South America* in the *Chap05* folder of this book's Student Sample Programs.

**Step 2:** Open the `Form1` form's code in the code editor. Insert the `using System.IO;` directive shown in line 10 of Program 5-6 at the end of this tutorial. This statement is necessary because the `StreamReader` class is part of the `System.IO` namespace in the .NET Framework.

**Step 3:** Open the Form1 form in the *Designer*. The form is shown, along with the names of the important controls, in Figure 5-36. Double-click the `getCountriesButton` control. This opens the code editor, and you will see an empty event handler named `getCountriesButton_Click`. Complete the `getCountriesButton_Click` event handler by typing the code shown in lines 23–46 in Program 5-6. Let’s take a closer look at the code:

**Line 23:** This is the beginning of a `try-catch` statement, which handles any exceptions that are thrown while the file is being processed. If an exception is thrown by any statement in the `try` block, the program jumps to the `catch` clause in line 50.

**Line 26:** This statement declares the `string` variable `countryName`, which holds the lines of text that are read from the file.

**Lines 29–32:** After these statements have executed, the `Countries.txt` file is opened for reading, and the `inputFile` variable references a `StreamReader` object that is associated with the file.

**Line 35:** This statement clears anything that might be displayed in the `countriesListBox` control. (This prevents the names of the countries from appearing multiple times in the `ListBox` if the user clicks the *Get Countries* button multiple times.)

**Line 38:** This is the beginning of a `while` loop that iterates as long as the end of the `Countries.txt` file has not been reached.

**Line 41:** This statement reads a line of text from the file and assigns it to the `countryName` variable.

**Line 44:** This statement adds the contents of the `countryName` variable to the `ListBox`.

**Line 48:** This statement closes the file.

**Step 4:** Switch your view back to the *Designer* and double-click the `exitButton` control. In the code editor you will see an empty event handler named `exitButton_Click`. Complete the `exitButton_Click` event handler by typing the code shown in lines 59–60 in Program 5-6.

**Step 5:** Save the project. Then, press `F5` on the keyboard or click the *Start Debugging* button (🐞) on the toolbar to compile and run the application. When the application runs, click the *Get Countries* button. This should fill the `ListBox` with the names of the countries from the `Countries.txt` file, as shown in Figure 5-38. Click the *Exit* button to exit the application.

**Figure 5-38** The *South America* application displaying the list of countries





**Program 5-6** Completed code for Form1 in the *South America* application

```
1 using System;
2 using System.Collections.Generic;
3 using System.ComponentModel;
4 using System.Data;
5 using System.Drawing;
6 using System.Linq;
7 using System.Text;
8 using System.Threading.Tasks;
9 using System.Windows.Forms;
10 using System.IO;
11
12 namespace South_America
13 {
14     public partial class Form1 : Form
15     {
16         public Form1()
17         {
18             InitializeComponent();
19         }
20
21         private void getCountriesButton_Click(object sender, EventArgs e)
22         {
23             try
24             {
25                 // Declare a variable to hold a country name.
26                 string countryName;
27
28                 // Declare a StreamReader variable.
29                 StreamReader inputFile;
30
31                 // Open the file and get a StreamReader object.
32                 inputFile = File.OpenText("Countries.txt");
33
34                 // Clear anything currently in the ListBox.
35                 countriesListBox.Items.Clear();
36
37                 // Read the file's contents.
38                 while (!inputFile.EndOfStream)
39                 {
40                     // Get a country name.
41                     countryName = inputFile.ReadLine();
42
43                     // Add the country name to the ListBox.
44                     countriesListBox.Items.Add(countryName);
45                 }
46
47                 // Close the file.
48                 inputFile.Close();
49             }
50             catch (Exception ex)
51             {
52                 // Display an error message.
53                 MessageBox.Show(ex.Message);
54             }
55         }
56
57         private void exitButton_Click(object sender, EventArgs e)
```

```

58     {
59         // Close the form.
60         this.Close();
61     }
62 }
63 }

```

## Calculating a Running Total

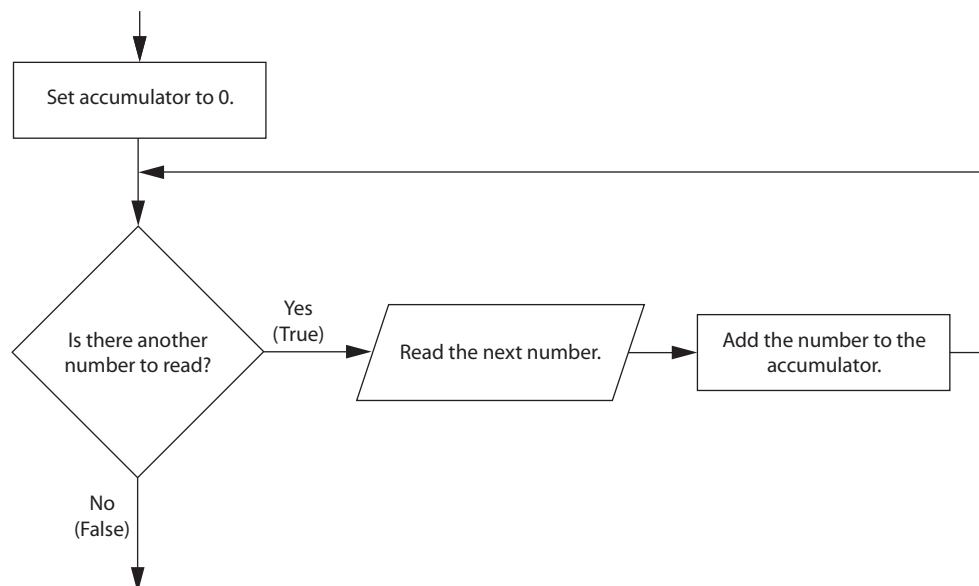
Many programming tasks require you to calculate the total of a series of numbers. In this section you learn how to calculate the total of a series of numbers that are stored in a file. For example, suppose you have a file that contains a business's sales for each day of a week and you need to write a program that calculates the total of all the amounts in the file. The program would read the values in the file and keep a total of the values as they are read.

Programs that calculate the total of a series of numbers typically use two elements:

- A loop that reads each number in the series
- A variable that accumulates the total of the numbers as they are read

The variable that is used to accumulate the total of the numbers is called an **accumulator**. It is often said that the loop keeps a **running total** because it accumulates the total as it reads each number in the series. Figure 5-39 shows the general logic of a loop that calculates a running total.

**Figure 5-39** Logic for calculating a running total



When the loop finishes, the accumulator will contain the total of the numbers that were read by the loop. Notice that the first step in the flowchart is to set the accumulator variable to 0. This is a critical step. Each time the loop reads a number, it adds it to the accumulator. If the accumulator starts with any value other than 0, it will not contain the correct total when the loop finishes.

In Tutorial 5-7 you will complete an application that calculates a running total of the values in a file.



VideoNote

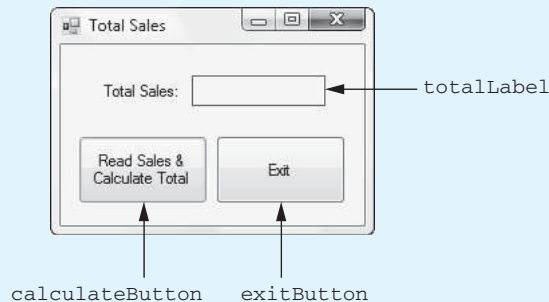
### Tutorial 5-7: Calculating a Running Total



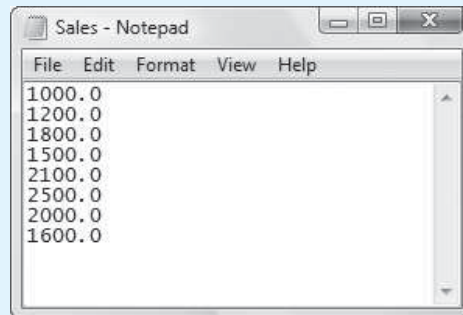
## Tutorial 5-7: Calculating a Running Total

In this tutorial you complete the *Total Sales* application that is found in the *Chap05* folder of this book's Student Sample Programs. The application's form has already been created and is shown in Figure 5-40. The application also has an accompanying text file named *Sales.txt* that is stored in the *bin\Debug* folder, under the project folder. The *Sales.txt* file contains the amounts shown in Figure 5-41.

**Figure 5-40** The *Total Sales* application's form



**Figure 5-41** Contents of the *Sales.txt* file



When the completed application runs and the user clicks the *Read Sales & Calculate Total* button, the application calculates the total of the values in the *Sales.txt* file and displays the total in the `totalLabel` control.

- Step 1:** Start Visual Studio (or Visual Studio Express). Open the project named *Total Sales* in the *Chap05* folder of this book's Student Sample Programs.
- Step 2:** Open the `Form1` form's code in the code editor. Insert the `using System.IO;` directive shown in line 10 of Program 5-7 at the end of this tutorial.
- Step 3:** Open the `Form1` form in the *Designer*. The form is shown, along with the names of the important controls, in Figure 5-40. Double-click the `calculateButton` control. This opens the code editor, and you will see an empty event handler named `calculateButton_Click`. Complete the `calculateButton_Click` event handler by typing the code shown in lines 23–56 in Program 5-7. Let's take a closer look at the code:

**Line 23:** This is the beginning of a `try-catch` statement, which handles any exceptions that are thrown while the file is being processed. If an exception is thrown by any statement in the `try` block, the program jumps to the `catch` clause in line 52.

**Lines 26–27:** These statements declare the `decimal` variables `sales` and `total`. The `sales` variable holds each value that is read from the file, and the `total` variable is used as an accumulator. Notice that the `total` variable is explicitly initialized to 0.

**Lines 30–33:** After these statements have executed, the `Sales.txt` file is opened for reading, and the `inputFile` variable references a `StreamReader` object that is associated with the file.

**Line 36:** This is the beginning of a `while` loop that iterates as long as the end of the `Countries.txt` file has not been reached.

**Line 39:** This statement reads a line of text from the file, converts it to a decimal, and assigns the result to the `sales` variable.

**Line 42:** This statement adds the `sales` variable to the `total` variable.

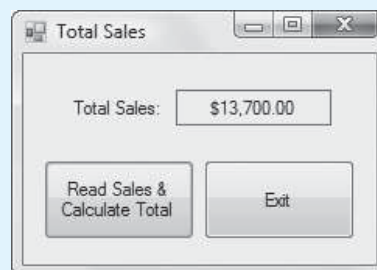
**Line 46:** This statement closes the file.

**Line 49:** This statement displays the total, formatted as currency, in the `totalLabel` control.

**Step 4:** Switch your view back to the *Designer* and double-click the `exitButton` control. In the code editor you will see an empty event handler named `exitButton_Click`. Complete the `exitButton_Click` event handler by typing the code shown in lines 61–62 in Program 5-7.

**Step 5:** Save the project. Then, press `[F5]` on the keyboard or click the *Start Debugging* button (🐞) on the toolbar to compile and run the application. When the application runs, click the *Read Sales & Calculate Total* button. The total sales should be calculated and displayed, as shown in Figure 5-42. Click the *Exit* button to exit the application.

**Figure 5-42** The *Total Sales* application displaying the total sales



**Program 5-7** Completed code for `Form1` in the *Total Sales* application

```
1 using System;
2 using System.Collections.Generic;
3 using System.ComponentModel;
4 using System.Data;
5 using System.Drawing;
6 using System.Linq;
7 using System.Text;
```

```

8 using System.Threading.Tasks;
9 using System.Windows.Forms;
10 using System.IO;
11
12 namespace Total_Sales
13 {
14     public partial class Form1 : Form
15     {
16         public Form1()
17         {
18             InitializeComponent();
19         }
20
21         private void calculateButton_Click(object sender, EventArgs e)
22         {
23             try
24             {
25                 // Variables
26                 decimal sales;           // To hold a sales amount
27                 decimal total = 0m;     // Accumulator, set to 0
28
29                 // Declare a StreamReader variable.
30                 StreamReader inputFile;
31
32                 // Open the file and get a StreamReader object.
33                 inputFile = File.OpenText("Sales.txt");
34
35                 // Read the file's contents.
36                 while (!inputFile.EndOfStream)
37                 {
38                     // Get a sales amount.
39                     sales = decimal.Parse(inputFile.ReadLine());
40
41                     // Add the sales amount to total.
42                     total += sales;
43                 }
44
45                 // Close the file.
46                 inputFile.Close();
47
48                 // Display the total.
49                 totalLabel.Text = total.ToString("C");
50
51             }
52             catch (Exception ex)
53             {
54                 // Display an error message.
55                 MessageBox.Show(ex.Message);
56             }
57         }
58
59         private void exitButton_Click(object sender, EventArgs e)
60         {
61             // Close the form.
62             this.Close();
63         }
64     }
65 }

```

 **Checkpoint**

- 5.18 What is an output file?
- 5.19 What is an input file?
- 5.20 What three steps must be taken by a program when it uses a file?
- 5.21 What is the difference between a text file and a binary file?
- 5.22 What are the two types of file access? What is the difference between these two?
- 5.23 What type of object do you create if you want to write data to a text file?
- 5.24 What type of object do you create if you want to read data from a text file?
- 5.25 If you call the `File.CreateText` method and the specified file already exists, what happens to the existing file?
- 5.26 If you call the `File.AppendText` method and the specified file already exists, what happens to the existing file?
- 5.27 What is the difference between the `writeLine` and `write` methods discussed in this chapter?
- 5.28 What method do you call to open a text file to read data from it?
- 5.29 What is a file's read position? Initially, where is the read position when an input file is opened?
- 5.30 How do you read a line of text from a text file?
- 5.31 How do you close a file?
- 5.32 Assume `inputFile` references a `StreamReader` object that is associated with an open file. Which of the following loops is written in the correct general format to read all of the items from the file?

*Loop A:*

```
while (inputFile.EndOfStream)
{
    // Read an item from the file.
}
```

*Loop B:*

```
while (!inputFile.EndOfStream)
{
    // Read an item from the file.
}
```

## 5.7 The OpenFileDialog and SaveFileDialog Controls

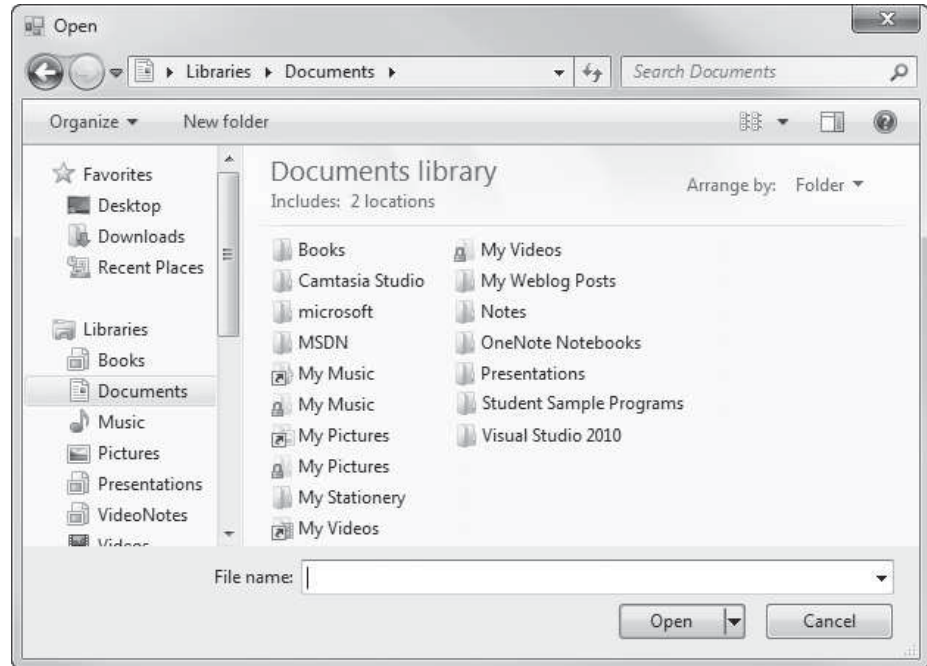
**CONCEPT:** The `OpenFileDialog` and `SaveFileDialog` controls allow your application to display standard Windows dialog boxes for opening and saving files. These allow the user to easily specify a file's name and location.

So far, the applications in this chapter that open a file specify the filename as a string literal. Most Windows users, however, are accustomed to using a dialog box to browse their disk for a file to open or for a location to save a file. You can use the `OpenFileDialog` and `SaveFileDialog` controls to equip applications with standard Windows dialog boxes for these purposes.

## The OpenFileDialog Control

The `OpenFileDialog` control displays a standard Windows *Open* dialog box, such as the one shown in Figure 5-43. The *Open dialog box* is useful in applications that must open an existing file because it allows the user to browse the system and select the file.

**Figure 5-43** Windows *Open* dialog box



### Adding the OpenFileDialog Control to Your Project

To add an `OpenFileDialog` control to a form, double-click the `OpenFileDialog` tool under the *Dialogs* group in the *Toolbox* window. When the control is created, it does not appear on the form, but in an area at the bottom of the *Designer* known as the **component tray**. Figure 5-44 shows an example of how an `OpenFileDialog` control appears in the component tray. The control's default name is `openFileDialog1`. As with other controls, you can change the control's `Name` property to change its name.

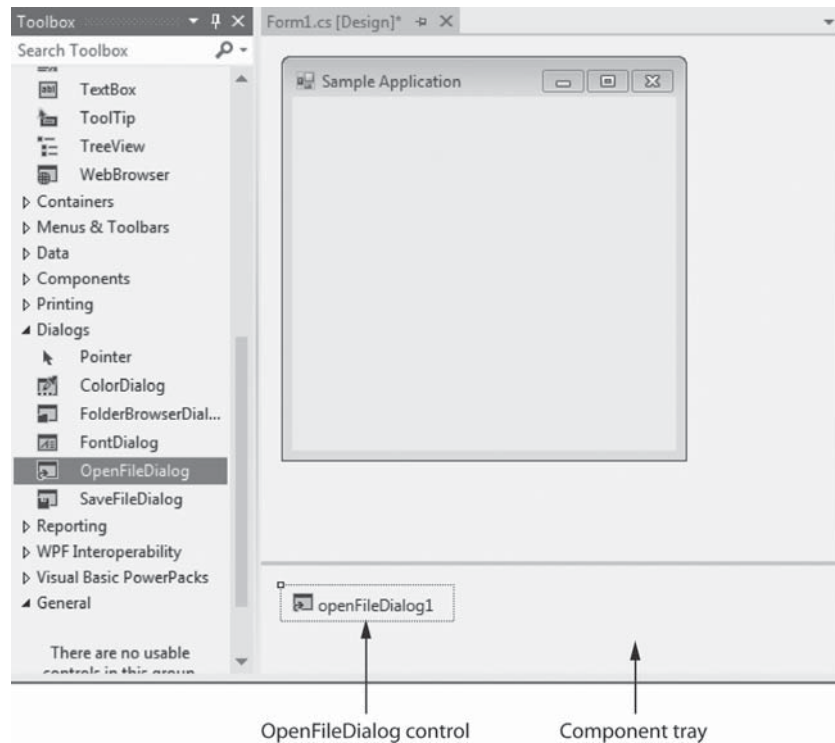
### Displaying an Open Dialog Box

In code, you can display an *Open* dialog box by calling the `OpenFileDialog` control's `ShowDialog` method. For example, assume that we have created an `OpenFileDialog` control and changed its name to `openFile`. The following statement calls the control's `ShowDialog` method:

```
openFile.ShowDialog();
```

In most cases, however, you will want to know whether the user clicked the *Open* button or the *Cancel* button to dismiss the *Open* dialog box. If the user clicked the *Open* button, it means that the user has selected a file and he or she can open it. If the user clicked the *Cancel* button, it means that the user does not want to proceed.

The `ShowDialog` method returns a value that indicates which button the user clicked to dismiss the dialog box. If the user clicked the *Open* button, the value `DialogResult.OK` is returned. If the user clicked the *Cancel* button, the value `DialogResult.Cancel` is returned. Assuming `openFile` is the name of an `OpenFileDialog` control, the following is

**Figure 5-44** An OpenFileDialog control in the component tray

an example of an *if-else* statement that calls the `ShowDialog` method and determines whether the user clicked the *Open* button or the *Cancel* button.

```

if (openFile.ShowDialog() == DialogResult.OK)
{
    MessageBox.Show("You clicked the Open button.");
}
else
{
    MessageBox.Show("You clicked the Cancel button.");
}

```

### The Filename Property

When the user selects a file with the *Open* dialog box, the file's path and filename are stored in the control's **Filename** property. Assume `openFile` is the name of an `OpenFileDialog` control. The following code is an example of how you can display an *Open* dialog box and, if the user clicks the *Open* button to dismiss the dialog box, open the selected file.

```

1 StreamReader inputFile;
2
3 if (openFile.ShowDialog() == DialogResult.OK)
4 {
5     // Open the selected file.
6     inputFile = File.OpenText(openFile.Filename);
7
8     // Continue processing the file...
9 }
10 else
11 {
12     MessageBox.Show("Operation canceled.");
13 }

```



Let's take a closer look at the code. The statement in line 1 declares a `StreamReader` variable named `inputFile`. The `if` statement in line 3 calls the `openFile` control's `ShowDialog` method to display an *Open* dialog box. If the user clicks the *Open* button to dismiss the dialog box, the program continues to line 6, where the name of the selected file is retrieved from the control's `Filename` property and that file is opened. Otherwise (if the user clicks the *Cancel* button), the program jumps to the `else` clause in line 10.



**TIP:** When you create an `OpenFileDialog` control, its `Filename` property is initially set to the control's default name. For example, if the control's default name is `openFileDialog1`, then the `Filename` property is also set to `openFileDialog1`. Always be sure to delete the default value of the `Filename` property.

### The InitialDirectory Property

By default, the *Open* dialog box displays the contents of the user's *Documents* directory (or folder). You can specify another directory to be initially displayed by storing its path in the **InitialDirectory** property. For example, the following code stores the path `C:\Data` in the `openFile` control's `InitialDirectory` property before displaying an *Open* dialog box:

```
openFile.InitialDirectory = "C:\Data";

if (openFile.ShowDialog() == DialogResult.OK)
{
    // Continue to process the selected file...
}
else
{
    // The operation was canceled.
}
```

In this example, when the *Open* dialog box is displayed it shows the contents of the directory `C:\Data`.

### The Title Property

By default, the word *Open* is displayed in an *Open* dialog box's title bar. You can change the default text displayed in the title bar by changing the control's **Title** property.

## The SaveFileDialog Control

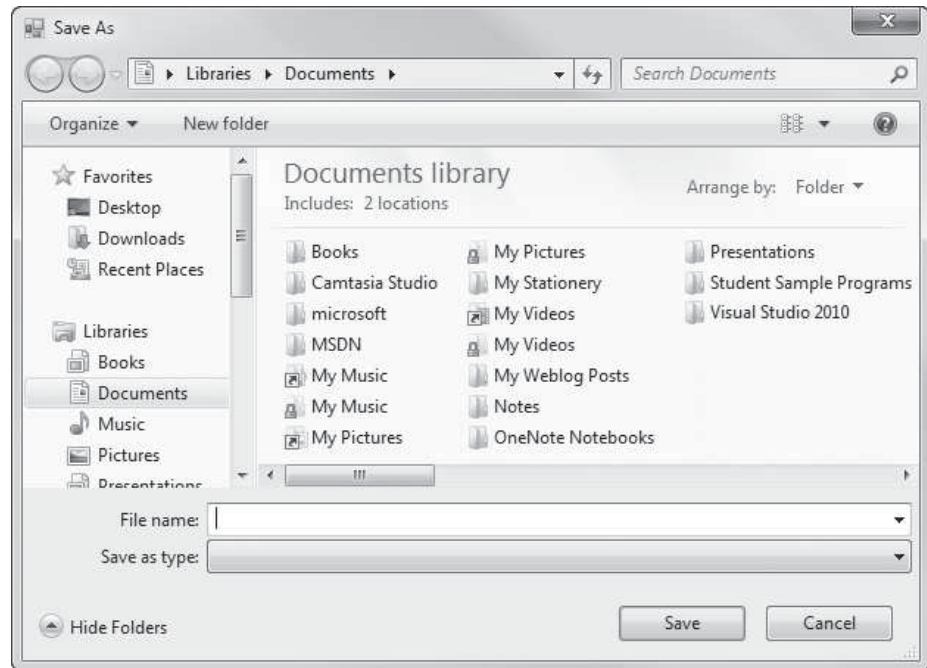
The `SaveFileDialog` control displays a standard Windows *Save As* dialog box, such as the one shown in Figure 5-45. The **Save As dialog box** allows the user to browse the system and select a location and name for a file that is about to be saved.

### Adding the SaveFileDialog Control to Your Project

The `SaveFileDialog` control has much in common with the `OpenFileDialog` control. To add a `SaveFileDialog` control to a form, double-click the `SaveFileDialog` tool under the *Dialogs* group in the *Toolbox* window. When the control is created, it appears in the component tray at the bottom of the *Designer*. The control will be given a default name such as `saveFileDialog1`, but you can change the name with the `Name` property.

### Displaying a Save As Dialog Box

In code, you can display a *Save As* dialog box by calling the `SaveFileDialog` control's `ShowDialog` method. For example, assume that we have created a `SaveFileDialog`

**Figure 5-45** Windows *Save As* dialog box

control and changed its name to `saveFile`. The following statement calls the control's `ShowDialog` method:

```
saveFile.ShowDialog();
```

The method returns a value indicating whether the user clicked the *Save* button or the *Cancel* button to dismiss the *Save As* dialog box. If the user clicks the *Save* button, the value `DialogResult.OK` is returned. If the user clicks the *Cancel* button, the value `DialogResult.Cancel` is returned. Assume `saveFile` is the name of a `SaveFileDialog` control. The following is an example of an `if-else` statement that calls the `ShowDialog` method and determines whether the user clicked the *Save* button or the *Cancel* button.

```
if (saveFile.ShowDialog() == DialogResult.OK)
{
    MessageBox.Show("You clicked the Save button.");
}
else
{
    MessageBox.Show("You clicked the Cancel button.");
}
```

### The Filename Property

When the user specifies a location and filename with the *Save As* dialog box, the file's path and filename are stored in the control's `Filename` property. Assume `saveFile` is the name of a `SaveFileDialog` control. The following code is an example of how you can display a *Save As* dialog box, and if the user clicks the *Save* button to dismiss the dialog box, open the selected file.

```
1 StreamWriter outputFile;
2
3 if (saveFile.ShowDialog() == DialogResult.OK)
4 {
```

```

5     // Create the selected file.
6     outputFile = File.CreateText(openFile.Filename);
7
8     // Write data to the file..
9 }
10 else
11 {
12     MessageBox.Show("Operation canceled.");
13 }

```

Let's take a closer look at the code. The statement in line 1 declares a `StreamWriter` variable named `outputFile`. The `if` statement in line 3 calls the `saveFile` control's `ShowDialog` method to display a *Save As* dialog box. If the user clicks the *Save* button to dismiss the dialog box, the program continues to line 6, where the selected name and path are retrieved from the control's `Filename` property, and that file is created. Otherwise (if the user clicks the *Cancel* button), the program jumps to the `else` clause in line 10.

### The InitialDirectory Property

By default, the *Save As* dialog box displays the contents of the user's *Documents* directory (or folder). You can specify another directory to be initially displayed by storing its path in the `InitialDirectory` property. The following code stores the path `C:\Data` in the `saveFile` control's `InitialDirectory` property before displaying a *Save As* dialog box:

```

saveFile.InitialDirectory = "C:\Data";

if (saveFile.ShowDialog() == DialogResult.OK)
{
    // Continue to process the file..
}
else
{
    // The operation was cancelled.
}

```

In this example, when the *Save As* dialog box is displayed, it shows the contents of the directory `C:\Data`.

### The Title Property

By default the words *Save As* are displayed in a *Save As* dialog box's title bar. You can change the default text displayed in the title bar by changing the control's `Title` property.



## Checkpoint

- 5.33 What is the benefit of using an *Open* and/or *Save As* dialog box in an application that works with files?
- 5.34 What is the purpose of the following `OpenFileDialog` and `SaveFileDialog` properties?
  - `InitialDirectory`
  - `Title`
  - `Filename`

## 5.8 Random Numbers

**CONCEPT:** Random numbers are used in a variety of applications. The .NET Framework provides the `Random` class that you can use in C# to generate random numbers.

Random numbers are useful for lots of different programming tasks. The following are just a few examples.

- Random numbers are commonly used in games. For example, computer games that let the player roll dice use random numbers to represent the values of the dice. Programs that show cards being drawn from a shuffled deck use random numbers to represent the face values of the cards.
- Random numbers are useful in simulation programs. In some simulations, the computer must randomly decide how a person, animal, insect, or other living being will behave. Formulas can be constructed in which a random number is used to determine various actions and events that take place in the program.
- Random numbers are useful in statistical programs that must randomly select data for analysis.
- Random numbers are commonly used in computer security to encrypt sensitive data.

The .NET Framework provides a class named `Random` that you can use in C# to generate random numbers. First you create an object from the `Random` class with a statement such as this:

```
Random rand = new Random();
```

Let's dissect the statement into two parts. The first part of the statement, appearing on the left side of the `=` operator, is as follows:

```
Random rand = new Random();
```

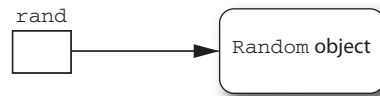
This declares a variable named `rand` that can reference a `Random` object.

This declares a variable named `rand` that can be used to reference a `Random` object. The second part of the statement, appearing on the right side of the `=` operator, is as follows:

```
Random rand = new Random();
```

This creates a `Random` object in memory.

The expression `new Random()` causes an object of the `Random` class to be created in memory. The `=` operator causes the `rand` variable to reference the `Random` object, as illustrated in Figure 5-46. After this statement has executed, we can use the `rand` variable to work with the `Random` object.

**Figure 5-46** The `rand` variable references a `Random` object

## The Next Method

Once you have created a `Random` object, you can call its `Next` method to get a random integer number. The following code shows an example:

```

// Declare an int variable.
int number;

// Create a Random object.
Random rand = new Random();

// Get a random integer and assign it to number.
number = rand.Next();
  
```

After this code executes, the `number` variable contains a random integer. If you call the `Next` method with no arguments, as shown in this example, the returned integer is somewhere between 0 and 2,147,483,647. Alternatively, you can pass an argument that specifies an upper limit to the generated number's range. In the following statement, the value assigned to `number` is somewhere between 0 and 99:

```
number = rand.Next(100);
```

The random integer's range does not have to begin at zero. You can add or subtract a value to shift the numeric range upward or downward. In the following statement, we call the `Next` method to get a random number in the range of 0 through 9, and then we add 1 to it. So, the number assigned to `number` is somewhere in the range of 1 through 10:

```
number = rand.Next(10) + 1;
```

The following statement shows another example. It assigns a random integer to `number` between  $-50$  and  $+49$ :

```
number = rand.Next(100) - 50
```

## The NextDouble Method

You can call a `Random` object's `NextDouble` method to get a random floating-point number between 0.0 and 1.0 (not including 1.0). The following code shows an example:

```

// Declare a Double variable.
double number;

// Create a Random object.
Random rand = new Random();

// Get a random number and assign it to number.
number = rand.NextDouble();
  
```

After this code executes, the `number` variable will contain a random floating-point number in the range of 0.0 up to (but not including) 1.0.

In Tutorial 5-8 you will use random numbers to determine whether the heads or tails side of a coin is facing up after the coin has been tossed.



## Tutorial 5-8 Simulating Coin Tosses



### Tutorial 5-8: Simulating Coin Tosses

In this tutorial you create an application that simulates the tossing of a coin. Each time the user tosses the coin, the application uses a `Random` object to get a random integer in the range of 0 through 1. If the random number is 0, it means the tails side of the coin is up, and if the random number is 1, it means the heads side is up. The application displays an image of a coin showing either heads or tails, depending on the value of the random number.

**Step 1:** Start Visual Studio (or Visual Studio Express) and begin a new Windows Forms Application project named *Coin Toss*.

**Step 2:** Set up the application’s form as shown in Figure 5-47. Notice that the form’s Text property is set to *Coin Toss*. The names of the controls are shown in the figure. As you place each of the controls on the form, refer to Table 5-1 for the relevant property settings. (Make sure the `headsPictureBox` control’s Visible property is set to True, and the `tailsPictureBox` control’s Visible property is set to False. This will cause the coin to initially appear heads up when the application runs.)

**Figure 5-47** Initial setup of the *Coin Toss* form

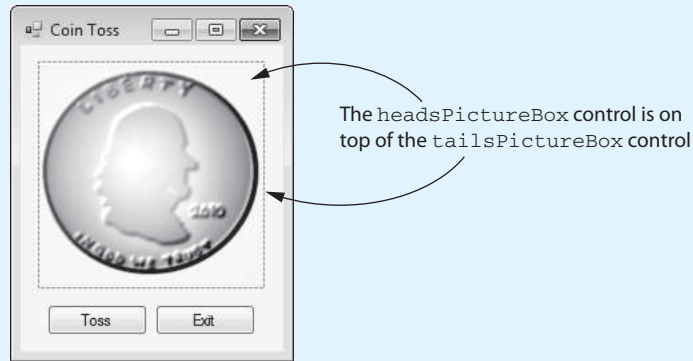


**Table 5-1** Control property settings

Control Name	Control Type	Property Settings
<code>headsPictureBox</code>	PictureBox	<b>Image:</b> Select and import the Heads1.bmp file from the <i>Chap05</i> folder of the Student Sample Programs. <b>Size:</b> 170, 170 <b>SizeMode:</b> Zoom <b>Visible:</b> True
<code>tailsPictureBox</code>	PictureBox	<b>Image:</b> Select and import the Tails1.bmp file from the <i>Chap05</i> folder of the Student Sample Programs. <b>Size:</b> 170, 170 <b>SizeMode:</b> Zoom <b>Visible:</b> False
<code>tossButton</code>	Button	<b>Text:</b> <i>Toss</i>
<code>exitButton</code>	Button	<b>Text:</b> <i>Exit</i>

**Step 3:** After you have set all of the control properties as shown in Table 5-1, move the PictureBox controls so one is on top of the other, as shown in Figure 5-48. (In the figure, the `headsPictureBox` control is on top, but it really doesn't matter which is on top.) Also, reduce the width of the form and position the button controls as shown in the figure.

**Figure 5-48** The controls repositioned and the form size adjusted



**Step 4:** Now you will create the Click event handlers for the Button controls. At the end of this tutorial, Program 5-8 shows the completed code for the form. You will be instructed to refer to Program 5-8 as you write the event handlers.

In the *Designer*, double-click the `tossButton` control. This opens the code editor, and you will see an empty event handler named `tossButton_Click`. Complete the `tossButton_Click` event handler by typing the code shown in lines 22–44 in Program 5-8. Let's take a closer look at the code:

**Line 23:** This statement declares an `int` variable named `sideUp`. This variable is used to hold a random number that indicates which side of the coin is up.

**Line 26:** This statement does the following:

- It declares a variable named `rand` that can be used to reference a `Random` object.
- It creates a `Random` object in memory.
- The `=` operator causes the `rand` variable to reference the `Random` object.

**Line 30:** This statement gets a random integer in the range of 0 through 1 and assigns it to the `sideUp` variable. The random integer represents which side of the coin is facing up. The value 0 means that the tails side is facing up, and the value 1 means that the heads side is facing up.

**Lines 33–44:** This `if-else` statement displays the side of the coin that is facing up. If `sideUp` equals 0, then the statements in lines 36 and 37 display the `tailsPictureBox` control and hide the `headsPictureBox` control. If `sideUp` equals 1, then the statements in lines 42 and 43 display the `headsPictureBox` control and hide the `tailsPictureBox` control.

**Step 5:** Switch your view back to the *Designer* and double-click the `exitButton` control. In the code editor you will see an empty event handler named `exitButton_Click`. Complete the `exitButton_Click` event handler by typing the code shown in lines 49–50 in Program 5-8.

**Step 6:** Save the project. Then, press **[F5]** on the keyboard or click the *Start Debugging* button (🐞) on the toolbar to compile and run the application. When the application runs, click the *Toss* button several times to simulate several coin tosses. When you are finished, click the *Exit* button to exit the application.

**Program 5-8** Completed code for Form1 in the *Coin Toss* application

```
1 using System;
2 using System.Collections.Generic;
3 using System.ComponentModel;
4 using System.Data;
5 using System.Drawing;
6 using System.Linq;
7 using System.Text;
8 using System.Threading.Tasks;
9 using System.Windows.Forms;
10
11 namespace Coin_Toss
12 {
13     public partial class Form1 : Form
14     {
15         public Form1()
16         {
17             InitializeComponent();
18         }
19
20         private void tossButton_Click(object sender, EventArgs e)
21         {
22             // Variable to indicate which side is up
23             int sideUp;
24
25             // Create a Random object.
26             Random rand = new Random();
27
28             // Get a random integer in the range of 0 through 1.
29             // 0 means tails up, 1 means heads up.
30             sideUp = rand.Next(2);
31
32             // Display the side that is up.
33             if (sideUp == 0)
34             {
35                 // Display tails up.
36                 tailsPictureBox.Visible = true;
37                 headsPictureBox.Visible = false;
38             }
39             else
40             {
41                 // Display heads up.
42                 headsPictureBox.Visible = true;
43                 tailsPictureBox.Visible = false;
44             }
45         }
46
47         private void exitButton_Click(object sender, EventArgs e)
48         {
49             // Close the form.
50             this.Close();
51         }
52     }
53 }
```



## Random Number Seeds

The numbers that are generated by the `Random` class are not truly random. Instead, they are **pseudorandom numbers** that are calculated by a formula. The formula used to generate random numbers has to be initialized with a value known as a seed value. The **seed value** is used in the calculation that returns the next random number in the series. When a `Random` object is created in memory, it retrieves the system time from the computer's internal clock and uses that as the seed value. The system time is an integer that represents the current date and time, down to a hundredth of a second.

If a `Random` object uses the same seed value each time it is created, it always generates the same series of random numbers. Because the system time changes every hundredth of a second, it is the preferred value to use as the seed in most cases. However, you can specify a different integer value as the seed, if you desire, when you create a `Random` object. Here is an example:

```
Random rand = new Random(1000);
```

In this example, the `Random` object that is created uses 1000 as the seed value. Each time a `Random` object is created with this statement, it generates the same series of random numbers. That may be desirable in some applications, when you always want to produce the same set of pseudorandom numbers.



### Checkpoint

- 5.35 What does a `Random` object's `Next` method return?
- 5.36 What does a `Random` object's `NextDouble` method return?
- 5.37 Write code that creates a `Random` object and then assigns a random integer in the range of 1 through 100 to the variable `randomNumber`.
- 5.38 Write code that creates a `Random` object and then assigns a random integer in the range of 100 through 399 to the variable `randomNumber`.
- 5.39 What does a `Random` object use as its seed value if you do not specify one?
- 5.40 What happens if the same seed value is used each time a `Random` object is created?

## 5.9 The Load Event

**CONCEPT:** When an application's form loads into memory, an event known as the **Load event** takes place. You can write an event handler for the Load event, and that handler will execute just before the form is displayed.

When you run an application, the application's form is loaded into memory and an event known as the **Load event** takes place. The Load event takes place before the form is displayed on the screen. If you want to execute some code at this point, you can write a Load event handler containing the desired code.

To create a Load event handler for a form, simply double-click any area of the form in the *Designer* window where there is no other control. The code editor will open with an empty Load event handler. If the form is named `Form1`, the event handler is named `Form1_Load`. Any code that you write inside the event handler executes when the form's Load event takes place. Here is an example of a Load event handler in a form named `Form1`:

```
private void Form1_Load(object sender, EventArgs e)
{
    MessageBox.Show("Prepare to see the form!");
}
```

Keep in mind that the Load event happens before the form is displayed on the screen. When the application containing this event handler runs, the message box is displayed before the form appears.

Load event handlers are useful for performing setup operations. In Tutorial 5-9 you will complete an application that uses a Load event handler to read items from a text file and add those items to a ListBox control.



VideoNote

**Tutorial 5-9:**  
Creating a  
Load Event  
Handler



## Tutorial 5-9: Creating a Load Event Handler

In this tutorial you complete the *Load Event* application that is found in the *Chap05* folder of this book's Student Sample Programs. This application is a variation of the *South America* application that you created in Tutorial 5-6. This version of the application uses a Load event handler to read the contents of the *Countries.txt* file and adds those items to a ListBox control.

The application's form has already been created and is shown in Figure 5-49. The application also has an accompanying text file named *Countries.txt*, that is stored in the *bin\Debug* folder, under the project folder. The *Countries.txt* file contains the names of the countries of South America.

**Figure 5-49** The *Load Event* application's form



- Step 1:** Start Visual Studio (or Visual Studio Express). Open the project named *Load Event* in the *Chap05* folder of this book's Student Sample Programs.
- Step 2:** Open the Form1 form's code in the code editor. Insert the **using System.IO;** directive shown in line 10 of Program 5-9 at the end of this tutorial. This statement is necessary because you will be using the `StreamReader` class, which is part of the `System.IO` namespace in the .NET Framework.
- Step 3:** Open the Form1 form in the *Designer*. The form is shown, along with the names of the important controls, in Figure 5-49. Double-click any part of the form that does not contain a control. (Be sure not to click the Label control, the ListBox control, or the Button control.) This opens the code editor, and you will see an empty event handler named `Form1_Load`. Complete the `Form1_Load` event handler by typing the code shown in lines 23–46 in Program 5-9. Let's take a closer look at the code:

**Line 23:** This is the beginning of a `try-catch` statement, which handles any exceptions that are thrown while the file is being processed. If an exception is thrown by any statement in the `try` block, the program jumps to the `catch` clause in line 47.

**Line 26:** This statement declares the `string` variable `countryName`, which holds the lines of text that are read from the file.

**Lines 29–32:** After these statements have executed, the `Countries.txt` file is opened for reading, and the `inputFile` variable references a `StreamReader` object that is associated with the file.

**Line 35:** This is the beginning of a `while` loop that iterates as long as the end of the `Countries.txt` file has not been reached.

**Line 38:** This statement reads a line of text from the file and assigns it to the `countryName` variable.

**Line 41:** This statement adds the contents of the `countryName` variable to the `ListBox`.

**Line 45:** This statement closes the file.

**Step 4:** Switch your view back to the *Designer* and double-click the `exitButton` control. In the code editor you will see an empty event handler named `exitButton_Click`. Complete the `exitButton_Click` event handler by typing the code shown in lines 56–57 in Program 5-9.

**Step 5:** Save the project. Then, press `F5` on the keyboard or click the *Start Debugging* button (▶) on the toolbar to compile and run the application. When the application runs, the `ListBox` should appear filled with the names of the countries from the `Countries.txt` file, as shown in Figure 5-50. Click the *Exit* button to exit the application.

**Figure 5-50** The *Load Event* application displaying the list of countries



**Program 5-9** Completed code for `Form1` in the *Load Event* application

```

1 using System;
2 using System.Collections.Generic;
3 using System.ComponentModel;
4 using System.Data;
5 using System.Drawing;
6 using System.Linq;
7 using System.Text;
8 using System.Threading.Tasks;
9 using System.Windows.Forms;
10 using System.IO;

```

```

11
12 namespace Load_Event
13 {
14     public partial class Form1 : Form
15     {
16         public Form1()
17         {
18             InitializeComponent();
19         }
20
21         private void Form1_Load(object sender, EventArgs e)
22         {
23             try
24             {
25                 // Declare a variable to hold a country name.
26                 string countryName;
27
28                 // Declare a StreamReader variable.
29                 StreamReader inputFile;
30
31                 // Open the file and get a StreamReader object.
32                 inputFile = File.OpenText("Countries.txt");
33
34                 // Read the file's contents.
35                 while (!inputFile.EndOfStream)
36                 {
37                     // Get a country name.
38                     countryName = inputFile.ReadLine();
39
40                     // Add the country name to the ListBox.
41                     countriesListBox.Items.Add(countryName);
42                 }
43
44                 // Close the file.
45                 inputFile.Close();
46             }
47             catch (Exception ex)
48             {
49                 // Display an error message.
50                 MessageBox.Show(ex.Message);
51             }
52         }
53
54         private void exitButton_Click(object sender, EventArgs e)
55         {
56             // Close the form.
57             this.Close();
58         }
59     }
60 }

```

## Checkpoint

- 5.41 When does the Load event take place?
- 5.42 How do you create an event handler for the Load event?

## Key Terms

accumulator	output file
binary file	postfix mode
body	posttest loop
component tray	prefix mode
counter variable	pretest loop
decrement	pseudorandom numbers
direct access file	random access file
file object	read position
filename	ReadLine method
filename extensions	running total
Filename property	Save As dialog box
increment	SaveFileDialog control
InitialDirectory property	seed value
initialization expression	sequential access file
input file	StreamReader class
Items.Add method	StreamWriter class
Items.Clear method	test expression
Items.Count property	text file
iteration	Title property
Load event	update expression
newline character	while clause
Next method	write method
Open dialog box	writeLine method
OpenFileDialog control	

## Review Questions

### Multiple Choice

- ListBox controls have an \_\_\_\_\_ method that erases all the items in the Items property.
  - Items.Erase
  - Items.Remove
  - Items.Clear
  - Items.Empty
- A \_\_\_\_\_ is commonly used to control the number of times that a loop iterates.
  - counter variable
  - test expression
  - while clause
  - controlled variable
- A(n) \_\_\_\_\_ tests its condition *before* performing an iteration.
  - preemptive loop
  - pretest loop
  - infinite loop
  - logical loop
- The term \_\_\_\_\_ is used to describe a file that data is written to.
  - input file
  - output file
  - saved file
  - user file

5. The term \_\_\_\_\_ is used to describe a file that data is read from.
  - a. data file
  - b. write file
  - c. read file
  - d. input file
6. A(n) \_\_\_\_\_ contains data that has been encoded as text, using a scheme such as Unicode.
  - a. text file
  - b. character file
  - c. Unicode file
  - d. system file
7. When you work with a \_\_\_\_\_ you access data from the beginning of the file to the end of the file.
  - a. direct access file
  - b. random access file
  - c. sequential access file
  - d. binary access file
8. Files on a disk are identified by a(n) \_\_\_\_\_.
  - a. unique identifier
  - b. filename
  - c. binary sequencer
  - d. file extension
9. A \_\_\_\_\_ is an object that is associated with a specific file and provides a way for the program to work with that file.
  - a. data object
  - b. directory object
  - c. stream object
  - d. file object
10. When a program works with an input file, a special value known as a(n) \_\_\_\_\_ is internally maintained for that file and marks the location of the next item that will be read from the file.
  - a. input locator
  - b. accumulator
  - c. read position
  - d. sequential read value
11. When the user selects a file with the *Open* dialog box, the file's path and filename are stored in the control's \_\_\_\_\_.
  - a. Filename property
  - b. FilePath property
  - c. Pathname property
  - d. Text property
12. The \_\_\_\_\_ displays a standard Windows *Save As* dialog box.
  - a. SaveAsDialog control
  - b. FileDialog control
  - c. SaveFileDialog control
  - d. StandardDialog control

13. Once you have created a `Random` object, you can call its \_\_\_\_\_ to get a random integer number.
  - a. `Generate` method
  - b. `Rand` method
  - c. `NextInteger` method
  - d. `Next` method
14. The \_\_\_\_\_ is used in the calculation that returns the next random number in the series.
  - a. `Start` value
  - b. seed value
  - c. `Next` value
  - d. sequence value
15. When you run an application, the application's form is loaded into memory and an event known as the \_\_\_\_\_ takes place.
  - a. Startup event
  - b. Begin event
  - c. Load event
  - d. Initialize event

### True or False

1. If the `ListBox` is empty, the `Items.Count` property equals `-1`.
2. The `while` loop is known as a pretest loop, which means it tests its condition *before* performing an iteration.
3. To increment a variable means to increase its value and to decrement a variable means to decrease its value.
4. When a variable is declared in the initialization expression of a `for` loop, the scope of the variable is limited to the loop.
5. The `while` loop always performs at least one iteration, even if its Boolean expression is false to begin with.
6. The term *read file* is used to describe a file that data is read from.
7. To append data to an existing file, you open it with the `File.AppendText` method.
8. As items are read from the file, the read position moves forward, toward the end of the file.
9. The numbers that are generated by the `Random` class are truly random.
10. The Load event takes place after the form is displayed on the screen.

### Short Answer

1. What is contained in the body of a loop?
2. Write a programming statement that uses postfix mode to increment a variable named `count`.
3. How many iterations will occur if the test expression of a `for` loop is false to begin with?
4. What are filename extensions? What do they indicate about a file?
5. When an input file is opened, what is its read position initially set to?

6. How can you read all of the items in a file without knowing how many items the file contains?
7. What is a variable that is used to accumulate a total called?
8. By default, the *Open* dialog box displays the contents of the user's *Documents* directory. How can you specify another directory to be initially displayed?
9. Why is the system time the preferred seed value for a *Random* object?
10. What kind of code should be placed in the *Load* event?

### Algorithm Workbench

1. Write a loop that displays your name 10 times.
2. Write a loop that displays all the odd numbers from 1 through 49.
3. Write a loop that displays every fifth number from 0 through 100.
4. Write a code sample that uses a loop to write the numbers from 1 through 10 to a file.
5. Assume that a file named *People.txt* contains a list of names. Write a code sample that uses a *while* loop to read the file and display its contents in a *ListBox* control.

## Programming Problems

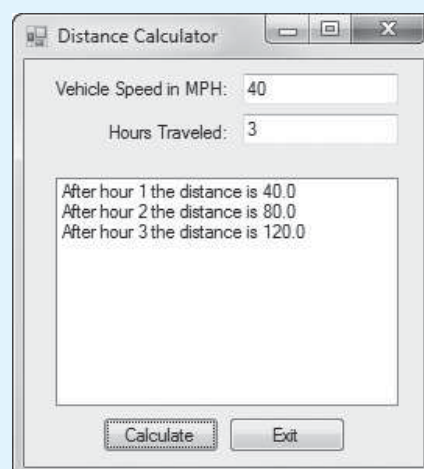
### 1. Distance Calculator

If you know a vehicle's speed and the amount of time it has traveled, you can calculate the distance it has traveled as follows:

$$\text{Distance} = \text{Speed} \times \text{Time}$$

For example, if a train travels 40 miles per hour for 3 hours, the distance traveled is 120 miles. Create an application with a form similar to the one shown in Figure 5-51. The user enters a vehicle's speed and the number of hours traveled into text boxes. When the user clicks the *Calculate* button, the application should use a loop to display in a list box the distance the vehicle has traveled for each hour of that time period.

**Figure 5-51** The *Distance Calculator* application







VideoNote  
Solving the  
Celsius-to-  
Fahrenheit  
Table  
problem

## 2. Distance File

Modify the *Distance Calculator* program that you wrote for Programming Problem 1 so it writes its output to a file instead of displaying it in a ListBox control. Open the file in Notepad or Visual Studio to confirm the output.

## 3. Celsius-to-Fahrenheit Table

Assuming that  $C$  is a Celsius temperature, the following formula converts the temperature to a Fahrenheit temperature ( $F$ ):

$$F = \frac{9}{5}C + 32$$

Create an application that displays a table of the Celsius temperatures 0–20 and their Fahrenheit equivalents. The application should use a loop to display the temperatures in a list box.

## 4. Population

Create an application that predicts the approximate size of a population of organisms. The application should use text boxes to allow the user to enter the starting number of organisms, the average daily population increase (as a percentage), and the number of days the organisms will be left to multiply. For example, assume the user enters the following values:

Starting number of organisms: 2

Average daily increase: 30%

Number of days to multiply: 10

The application should display the following table of data in a ListBox control.

Day	Approximate Population
1	2
2	2.6
3	3.38
4	4.394
5	5.7122
6	7.42586
7	9.653619
8	12.5497
9	16.31462
10	21.209

## 5. Pennies for Pay

Susan is hired for a job, and her employer agrees to pay her every day. Her employer also agrees that Susan's salary is 1 penny the first day, 2 pennies the second day, 4 pennies the third day, continuing to double each day. Create an application that allows the user to enter the number of days that Susan will work and calculates the total amount of pay she will receive over that period of time.

## 6. Ocean Levels

Assuming the ocean's level is currently rising at about 1.5 millimeters per year, create an application that displays the number of millimeters that the ocean will have risen each year for the next 10 years. Display the output in a ListBox control.

**7. Calories Burned**

Running on a particular treadmill, you burn 3.9 calories per minute. Create an application that uses a loop to display the number of calories burned after 10, 15, 20, 25, and 30 minutes. Display the output in a ListBox control.

**8. Tuition Increase**

At one college the tuition for a full-time student is \$6000 per semester. It has been announced that the tuition will increase by 2 percent each year for the next five years. Create an application with a loop that displays the projected semester tuition amount for the next 5 years in a ListBox control.

**9. Dice Simulator**

Create an application that simulates rolling a pair of dice. When the user clicks a button, the application should generate two random numbers, each in the range of 1 through 6, to represent the value of the dice. Use PictureBox controls to display the dice. (In the Student Sample Programs, in the *Chap05* folder, you will find six images named *Die1.bmp*, *Die2.bmp*, *Die3.bmp*, *Die4.bmp*, *Die5.bmp*, and *Die6.bmp* that you can use in the PictureBoxes.)

**10. Addition Tutor**

Create an application that generates two random integers, each in the range of 100 through 500. The numbers should be displayed as addition problems on the application's form, such as

$$247 + 129 = ?$$

The form should have a text box for the user to enter the problem's answer. When a button is clicked, the application should do the following:

- Check the user's input and display a message indicating whether it is the correct answer.
- Generate two new random numbers and display them in a new problem on the form.

**11. Random Number Guessing Game**

Create an application that generates a random number in the range of 1 through 100 and asks the user to guess what the number is. If the user's guess is higher than the random number, the program should display "Too high, try again." If the user's guess is lower than the random number, the program should display "Too low, try again." If the user guesses the number, the application should congratulate the user and then generate a new random number so the game can start over.

Optional Enhancement: Enhance the game so it keeps count of the number of guesses that the user makes. When the user correctly guesses the random number, the program should display the number of guesses.

**12. Calculating the Factorial of a Number**

In mathematics, the notation  $n!$  represents the factorial of the nonnegative integer  $n$ . The factorial of  $n$  is the product of all the nonnegative integers from 1 through  $n$ . For example,

$$7! = 1 \times 2 \times 3 \times 4 \times 5 \times 6 \times 7 = 5,040$$

and

$$4! = 1 \times 2 \times 3 \times 4 = 24$$

Create an application that lets the user enter a nonnegative integer and then uses a loop to calculate the factorial of that number. Display the factorial in a label or a message box.

**13. Random Number File Writer**

Create an application that writes a series of random numbers to a file. Each random number should be in the range of 1 through 100. The application should let the user specify how many random numbers the file will hold and should use a `SaveFileDialog` control to let the user specify the file's name and location.

**14. Random Number File Reader**

This exercise assumes you have completed Programming Problem 13, *Random Number File Writer*. Create another application that uses an `OpenFileDialog` control to let the user select the file that was created by the application that you wrote for Problem 13. This application should read the numbers from the file, display the numbers in a `ListBox` control, and then display the following data:

- The total of the numbers
- The number of random numbers read from the file

## TOPICS

- |                                  |                                    |
|----------------------------------|------------------------------------|
| 6.1 Introduction to Methods      | 6.4 Passing Arguments by Reference |
| 6.2 void Methods                 | 6.5 Value-Returning Methods        |
| 6.3 Passing Arguments to Methods |                                    |

## 6.1

## Introduction to Methods

**CONCEPT:** Methods can be used to break a complex program into small, manageable pieces. A `void` method simply executes a group of statements and then terminates. A value-returning method returns a value to the statement that called it.

In a general sense, a method is a collection of statements that performs a specific task. So far you have experienced methods in two ways:

- You have created event handlers. An event handler is a special type of method that responds to events.
- You have executed predefined methods from the .NET Framework, such as `MessageBox.Show` and the `TryParse` methods.

In this chapter you will learn how to create your own methods that can be executed just as you execute the .NET Framework methods.

Methods are commonly used to break a problem into small, manageable pieces. Instead of writing one long method that contains all the statements necessary to solve a problem, you can write several small methods that each solve a specific part of the problem. These small methods can then be executed in the desired order to solve the problem. This approach is sometimes called **divide and conquer** because a large problem is divided into several smaller problems that are easily solved. Figures 6-1 and 6-2 illustrate this idea by comparing two programs: one that uses a long, complex event handler containing all the statements necessary to solve a problem and another that divides a problem into smaller problems, each of which are handled by a separate method.

**Figure 6-1** Using one long sequence of statements to perform a task

```
namespace Example
{
    public partial class Form1 : Form
    {
        private void myButton_Click(object sender, EventArgs e)
        {
            statement;
            statement;
            statement;
            statement;
            statement;
            statement;
            statement;
            statement;
            statement;
            statement;
            statement;
            statement;
            statement;
            statement;
            ... and so on.
        }
    }
}
```

In this program the task is performed by one long sequence of statements in an event handler.

**Figure 6-2** Using methods to divide and conquer a problem

```
namespace Example
{
    public partial class Form1 : Form
    {
        private void myButton_Click(object sender, EventArgs e)
        {
            Method2();
            Method3();
            Method4();
        }
        private void Method2()
        {
            statement;
            statement;
            statement;
        }
        private void Method3()
        {
            statement;
            statement;
            statement;
        }
        private void Method4()
        {
            statement;
            statement;
            statement;
        }
    }
}
```

Event Handler

Method 2

Method 3

Method 4

In this program the task has been divided into smaller tasks, each of which is performed by a separate method.

In general terms, a program that is broken into smaller units of code, such as methods, is known as a **modularized program**. Modularization tends to simplify code. If a specific task is performed in several places in a program, a method can be written once to perform that task and then be executed any time it is needed. This benefit of using methods is known as **code reuse** because you are writing the code to perform a task once and then reusing it each time you need to perform the task.

## void Methods and Value-Returning Methods

In this chapter you will learn to write two types of methods: **void** methods and **value-returning** methods. When you call a **void method**, it simply executes the statements it contains and then terminates. When you call a **value-returning method**, it executes the statements that it contains and then it returns a value back to the statement that called it. The `Parse` methods are good examples of value-returning methods. The first type of method that you will learn to write is the **void** method.

### 6.2 void Methods

**CONCEPT:** A **void** method performs a task and then terminates. It does not return a value back to the statement that called it.

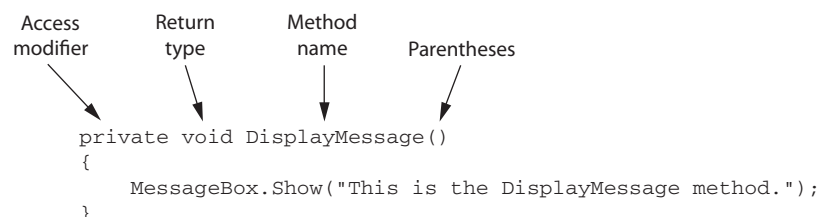
To create a method you write its definition. A method definition has two parts: a header and a body. The **method header**, which appears at the beginning of a method definition, lists several important things about the method, including the method's name. The **method body** is a collection of statements that are performed when the method is executed. These statements are enclosed inside a set of curly braces. Here is an example of a method definition:

```
private void DisplayMessage()
{
    MessageBox.Show("This is the DisplayMessage method.");
}
```

### The Method Header

Using the previously shown method definition, Figure 6-3 points out the different parts of the method header, which is the first line.

**Figure 6-3** Parts of the method header



Let's take a closer look at the parts identified in the figure:

- **Access modifier**—The keyword `private` is an access modifier. When a method is declared as `private`, it can be called only by code inside the same class as the method. Alternatively, a method that is declared as `public` can be called by code that is outside the class. This is important because some applications have multiple classes, and unless you specifically intend a method to be available to code outside the class, you should declare it `private`.
- **Return type**—Recall our previous discussion of `void` and value-returning methods. When the keyword `void` appears here, it means that the method is a **void** method, and does not return a value. As you will see later in this chapter, a value-returning method lists a data type here.

- **Method name**—You should give each method a descriptive name. In general, the same rules that apply to variable names also apply to method names. The method in this example is named `DisplayMessage`, so we can easily guess what the method does: It displays a message.

In this book we use **Pascal case** for method names. Pascal case is like camelCase (the convention we have been using for variable names), except in a Pascal case name the first character is always uppercase. It is a standard convention among C# programmers to use Pascal case for method names because it differentiates method names from variable and field names.

- **Parentheses**—In the header, the method name is always followed by a set of parentheses. As you will see later in this chapter, you sometimes write declarations inside the parentheses, but for now, the parentheses will be empty.



**NOTE:** The method header is never terminated with a semicolon.

## The Method Body

Beginning at the line after the method header, one or more statements appear inside a set of curly braces (`{ }`). These statements are the method's body and are performed any time the module is executed.

When you write a method definition, Visual Studio automatically indents the statements in the method body. The indentation is not required, but it makes the code easier to read and debug. By indenting the statements in the body of the method, you visually set them apart from the surrounding code. This allows you to tell at a glance what part of the program is part of the method.

## Declaring Methods Inside a Class

Methods usually belong to a class, so you must write a method's definition inside the class to which it is supposed to belong. In this chapter, all the methods that you will write will belong to an application's `Form1` class. When you write a method's definition, you write it inside the `Form1` class, as shown in Figure 6-4.

**Figure 6-4** Write method definitions inside the `Form1` class

```
using System;
using System.Collections.Generic;
using System.ComponentModel;
using System.Data;
using System.Drawing;
using System.Linq;
using System.Text;
using System.Threading.Tasks;
using System.Windows.Forms;

namespace Example
{
    public partial class Form1 : Form
    {
        public Form1()
        {
            InitializeComponent();
        }
    }
}
```

← Your method definitions will appear here, inside the `Form1` class.

## Calling a Method

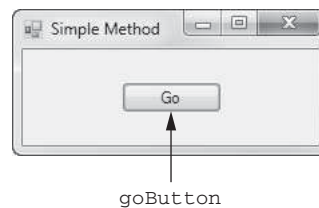
A method executes when it is called. Event handlers are called when specific events take place, but other methods are executed by method call statements. When a method is called, the program branches to that method and executes the statements in its body. Here is an example of a method call statement that calls the `DisplayMessage` method we previously examined:

```
DisplayMessage();
```

The statement is simply the name of the method followed by a set of parentheses. Because it is a complete statement, it is terminated with a semicolon.

Let's look at a complete program that uses the `DisplayMessage` method. In the *Chap06* folder of this book's Student Sample Programs is a project named *Simple Method*. Figure 6-5 shows the application's form, and Program 6-1 shows the form's code.

**Figure 6-5** The *Simple Method* application's form



**Program 6-1** Code for the *Simple Method* application's Form1 form

```

1 using System;
2 using System.Collections.Generic;
3 using System.ComponentModel;
4 using System.Data;
5 using System.Drawing;
6 using System.Linq;
7 using System.Text;
8 using System.Threading.Tasks;
9 using System.Windows.Forms;
10
11 namespace Simple_Method
12 {
13     public partial class Form1 : Form
14     {
15         public Form1()
16         {
17             InitializeComponent();
18         }
19
20         private void goButton_Click(object sender, EventArgs e)
21         {
22             MessageBox.Show("This is the goButton_Click method.");
23             DisplayMessage();
24             MessageBox.Show("Back in the goButton_Click method.");
25         }
26
27         private void DisplayMessage()
28         {
29             MessageBox.Show("This is the DisplayMessage method.");
30         }
31     }
32 }

```



Let's step through the code. When the user clicks the *Go* button, the `goButton_Click` event handler executes. Inside the event handler the statement in line 22 displays *This is the goButton\_Click method* in a message box. Then, line 23 calls the `DisplayMessage` method. As shown in Figure 6-6, the program jumps to the `DisplayMessage` method and executes the statements in its body. There is only one statement in the body of the `DisplayMessage` method, which is line 29. This statement displays *This is the DisplayMessage method*, and then the method ends. As shown in Figure 6-7, the program jumps back to the part of the program that called the `DisplayMessage` method and resumes execution from that point. In this case, the program resumes execution at line 24, which displays *Back in the goButton\_Click method*. The `goButton_Click` event handler ends at line 25.

**Figure 6-6** Calling the `DisplayMessage` method

The program jumps to the `DisplayMessage` method and executes the statement in its body.

```
private void goButton_Click(object sender, EventArgs e)
{
    MessageBox.Show("This is the goButton_Click method.");
    DisplayMessage();
    MessageBox.Show("Back in the goButton_Click method.");
}

private void DisplayMessage()
{
    MessageBox.Show("This is the DisplayMessage method.");
}
```

**Figure 6-7** The `DisplayMessage` method returns

When the `DisplayMessage` method ends, the program returns to the part of the program that called it, and resumes execution at the point.

```
private void goButton_Click(object sender, EventArgs e)
{
    MessageBox.Show("This is the goButton_Click method.");
    DisplayMessage();
    MessageBox.Show("Back in the goButton_Click method.");
}

private void DisplayMessage()
{
    MessageBox.Show("This is the DisplayMessage method.");
}
```

When a method is called, some operations are performed “behind the scenes” so the system will know to where the program should return after the method ends. First, the system saves the memory address of the location to which it should return. This is typically the statement that appears immediately after the method call. This memory location is known as the **return point**. Then, the system jumps to the method and executes the statements in its body. When the method ends, the system jumps back to the return point and resumes execution.



**NOTE:** When a program calls a method, programmers commonly say that the *control* of the program transfers to that method. This simply means that the method takes control of the program's execution.

In Tutorial 6-1 you will get hands-on practice writing and calling methods.



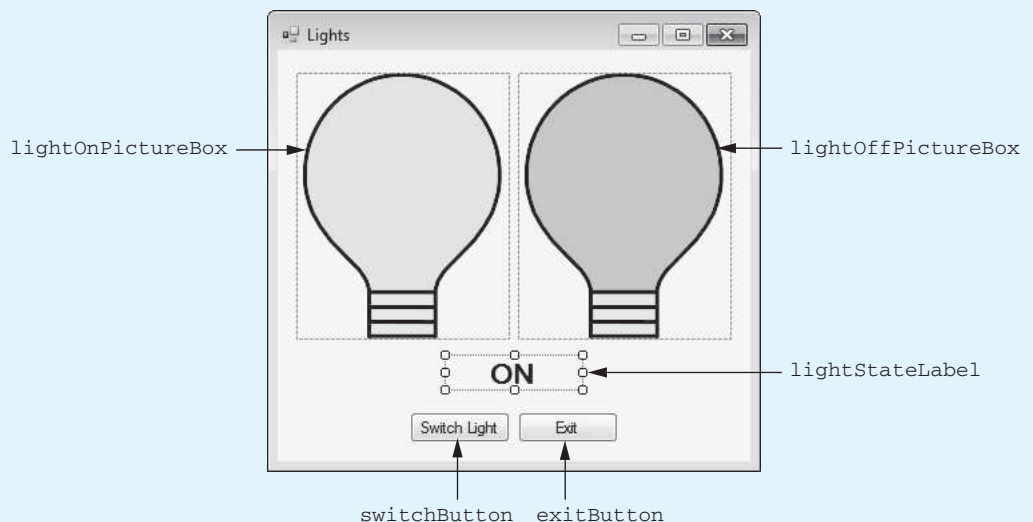
VideoNote

**Tutorial 6-1:**  
Creating and  
Calling  
Methods

## Tutorial 6-1: Creating and Calling Methods

The *Chap06* folder in this book's Student Sample Programs contains a partially created project named *Lights*. In this tutorial you complete the project so it simulates a light being turned off or on. The project's form, in its initial setup, is shown in Figure 6-8.

**Figure 6-8** The *Lights* project's form in its initial setup



Here are some details about specific property settings:

- The `lightOnPictureBox` control's `Visible` property is initially set to `True`.
- The `lightOffPictureBox` control's `Visible` property is initially set to `False`.
- The `lightStateLabel` displays either `ON` or `OFF` while the application runs to indicate whether the light is on or off. Initially, this control's `Text` property is set to `ON`.

At run time, when the user clicks the *Switch Light* button, the state of the light is reversed. In other words, if the light is currently on, it will be turned off. If the light is currently off, it will be turned on.

When the light is turned on, the following actions take place:

- The `lightOnPictureBox` control's `Visible` property is set to `true`.
- The `lightOffPictureBox` control's `Visible` property is set to `false`.
- The `lightStateLabel` label's `Text` property is assigned the string `"ON"`.

When the light is turned off, the following actions take place:

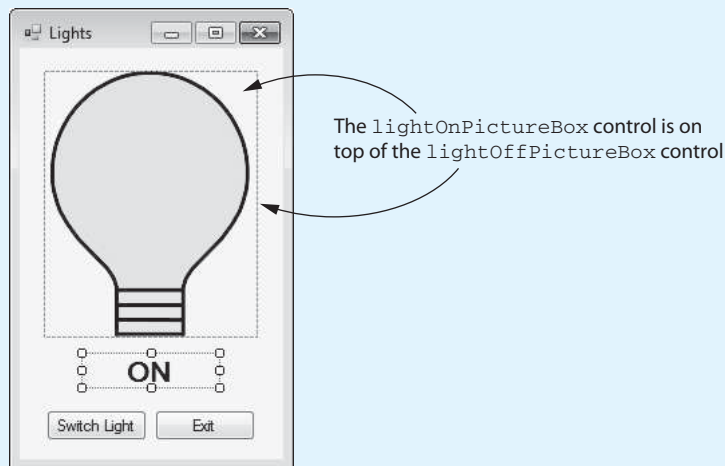
- The `lightOffPictureBox` control's `Visible` property is set to `true`.
- The `lightOnPictureBox` control's `Visible` property is set to `false`.
- The `lightStateLabel` label's `Text` property is assigned the string `"OFF"`.

To modularize the code, you create a method named `TurnLightOn` (containing the code to turn the light on), and another method named `TurnLightOff` (containing the code to

turn the light off). When you need to turn the light on, you call the `TurnLightOn` method and when you need to turn the light off you call the `TurnLightOff` method.

- Step 1:** Start Visual Studio (or Visual Studio Express). Open the project named *Lights* in the *Chap06* folder of this book's Student Sample Programs.
- Step 2:** Open the *Form1* form in the *Designer*. The form is shown, along with the names of the important controls, in Figure 6-8.
- Step 3:** Move the *PictureBox* controls so one is on top of the other, as shown in Figure 6-9. (In the figure, the `lightOnPictureBox` control is on top, but it really does not matter which is on top.) Also, reduce the width of the form and position the button controls as shown in the figure.

**Figure 6-9** The controls repositioned and the form size adjusted



- Step 4:** Program 6-2, at the end of this tutorial, shows the form's completed code. Open the code editor and type the code for the `TurnLightOn` and the `TurnLightOff` methods, shown in lines 20–42 of Program 6-2.


Let's take a closer look at the code. Line 20 is the beginning of a method named `TurnLightOn`. The purpose of this method is to simulate the light turning on. When this method executes, line 23 makes the `lightOnPictureBox` control visible, line 26 makes the `lightOffPictureBox` control invisible, and line 29 sets the `lightStateLabel` control's `Text` property to "ON".

Line 32 is the beginning of a method named `TurnLightOff`. The purpose of this method is to simulate the light turning off. When this method executes, line 35 makes the `lightOffPictureBox` control visible, line 38 makes the `lightOnPictureBox` control invisible, and line 41 sets the `lightStateLabel` control's `Text` property to "OFF".

- Step 5:** Next, you create the Click event handlers for the Button controls. Switch back to the *Designer* and double-click the `switchButton` control. This opens the code editor, and you will see an empty event handler named `switchButton_Click`. Complete the `switchButton_Click` event handler by typing the code shown in lines 46–54 in Program 6-2.

Let's review this code. The `if` statement in line 47 determines whether the `lightOnPictureBox` control is visible. If it is, it means the light is turned on, so the statement in line 49 calls the `TurnLightOff` method to turn the light off.

Otherwise, the `else` clause in line 51 takes over, and the `TurnLightOn` method is called on line 53 to turn the light on.

- Step 6:** Switch your view back to the *Designer* and double-click the `exitButton` control. In the code editor you will see an empty event handler named `exitButton_Click`. Complete the `exitButton_Click` event handler by typing the code shown in lines 59–60 in Program 6-2.
- Step 7:** Save the project. Then, press `[F5]` on the keyboard, or click the *Start Debugging* button  on the toolbar to compile and run the application. When the application runs, click the *Switch Light* button several times to simulate several coin tosses. When you are finished, click the *Exit* button to exit the application.

### Program 6-2 Completed code for Form1 in the *Lights* application

```

1 using System;
2 using System.Collections.Generic;
3 using System.ComponentModel;
4 using System.Data;
5 using System.Drawing;
6 using System.Linq;
7 using System.Text;
8 using System.Threading.Tasks;
9 using System.Windows.Forms;
10
11 namespace Lights
12 {
13     public partial class Form1 : Form
14     {
15         public Form1()
16         {
17             InitializeComponent();
18         }
19
20         private void TurnLightOn()
21         {
22             // Display the "light on" image.
23             lightOnPictureBox.Visible = true;
24
25             // Hide the "light off" image.
26             lightOffPictureBox.Visible = false;
27
28             // Display the light's state.
29             lightStateLabel.Text = "ON";
30         }
31
32         private void TurnLightOff()
33         {
34             // Display the "light off" image.
35             lightOffPictureBox.Visible = true;
36
37             // Hide the "light on" image.
38             lightOnPictureBox.Visible = false;
39
40             // Display the light's state.
41             lightStateLabel.Text = "OFF";
42         }
43
44         private void switchButton_Click(object sender, EventArgs e)

```

```

45     {
46         // Reverse the state of the light.
47         if (lightOnPictureBox.Visible == true)
48         {
49             TurnLightOff();
50         }
51         else
52         {
53             TurnLightOn();
54         }
55     }
56
57     private void exitButton_Click(object sender, EventArgs e)
58     {
59         // Close the form.
60         this.Close();
61     }
62 }
63 }

```

## Top-Down Design

In this section, we have discussed and demonstrated how methods work. You have seen how the program jumps to a method when it is called and returns to the part of the program that called the method when the method ends. It is important that you understand these mechanical aspects of methods.

Just as important as understanding how methods work is understanding how to use methods to modularize a program. Programmers commonly use a technique known as **top-down design** to break down an algorithm into methods. The process of top-down design is performed in the following manner:

- The overall task that the program is to perform is broken down into a series of subtasks.
- Each subtask is examined to determine whether it can be further broken down into more subtasks. This step is repeated until no more subtasks can be identified.
- Once all of the subtasks have been identified, they are written in code.

This process is called top-down design because the programmer begins by looking at the topmost level of tasks that must be performed and then breaks down those tasks into lower levels of subtasks.



**NOTE:** The top-down design process is sometimes called **stepwise refinement**.



## Checkpoint

- 6.1 What is the difference between a void method and a value-returning method?
- 6.2 What two parts does a method definition have?
- 6.3 What does the phrase “calling a method” mean?
- 6.4 When a void method is executing, what happens when the end of the method is reached?
- 6.5 Describe the steps involved in the top-down design process.

## 6.3 Passing Arguments to Methods

**CONCEPT:** An argument is any piece of data that is passed into a method when the method is called. A parameter is a variable that receives an argument that is passed into a method.

Sometimes it is useful not only to call a method, but also to send one or more pieces of data into the method. Pieces of data that are sent into a method are known as **arguments**. The method can use its arguments in calculations or other operations.

You are already familiar with how to use arguments in a method call. For example, look at the following statement:

```
MessageBox.Show("Hello");
```

This statement calls the `MessageBox.Show` method and passes the string "Hello" as an argument. Here is another example:

```
number = int.Parse(str);
```

Assume that `number` is an `int` variable and `str` is a `string` variable. This statement calls the `int.Parse` method, passing the `str` variable as an argument.

If you are writing a method and you want it to receive arguments when it is called, you must equip the method with one or more parameter variables. A **parameter variable**, often simply called a **parameter**, is a special variable that receives an argument when a method is called. Here is an example of a method that has a parameter variable:

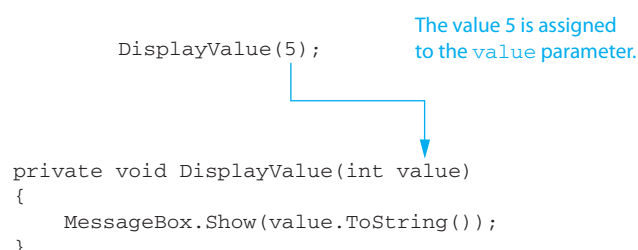
```
private void DisplayValue(int value)
{
    MessageBox.Show(value.ToString());
}
```

Notice the `int` variable declaration that appears inside the parentheses (`int value`). This is the declaration of a parameter variable, which enables the `DisplayValue` method to accept an `int` value as an argument. Here is an example of a call to the `DisplayValue` method, passing 5 as an argument:

```
DisplayValue(5);
```

This statement executes the `DisplayValue` method. The argument that is listed inside the parentheses is assigned to the method's parameter variable, `value`. This is illustrated in Figure 6-10.

**Figure 6-10** Passing the value 5 to the `DisplayValue` method



Inside the `DisplayValue` method, the variable `value` will contain the value of whatever argument was passed into it. If we pass 5 as the argument, the method will display the value 5 in a message box.

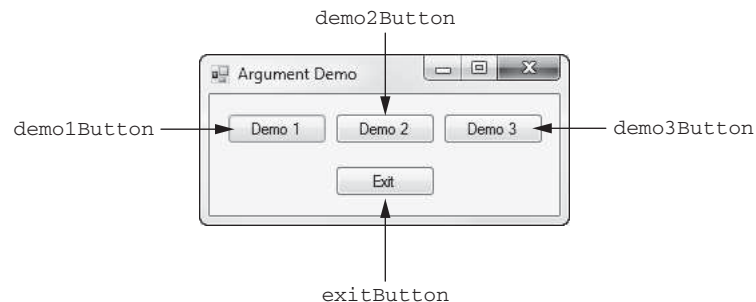
You may also pass the contents of variables and the values of expressions as arguments. For example, the following statements call the `DisplayValue` method with various arguments passed:

```
DisplayValue(x);
DisplayValue(x * 4);
DisplayValue(int.Parse("700"));
```

The first statement is simple. It passes the value of the variable `x` as the argument to the `DisplayValue` method. The second statement is also simple, but it does a little more work: it passes the result of the expression `x * 4` as the argument to the `DisplayValue` method. The third statement does even more work. It passes the value returned from the `int.Parse` method as the argument to the `DisplayValue` method. (The `int.Parse` method is called first, and its return value is passed to the `DisplayValue` method.)

In the *Chap06* folder of this book's Student Sample Programs, you will find a project named *Argument Demo* that demonstrates this method. Figure 6-11 shows the application's form, and Program 6-3 shows the form's code.

**Figure 6-11** The *Argument Demo* application's form



**Program 6-3** Code for the *Argument Demo* application's Form1 form

```
1 using System;
2 using System.Collections.Generic;
3 using System.ComponentModel;
4 using System.Data;
5 using System.Drawing;
6 using System.Linq;
7 using System.Text;
8 using System.Threading.Tasks;
9 using System.Windows.Forms;
10
11 namespace Argument_Demo
12 {
13     public partial class Form1 : Form
14     {
15         public Form1()
16         {
17             InitializeComponent();
18         }
19
20         private void DisplayValue(int value)
21         {
22             MessageBox.Show(value.ToString());
```

```

23     }
24
25     private void demo1Button_Click(object sender, EventArgs e)
26     {
27         // Call DisplayValue passing 5 as an argument.
28         DisplayValue(5);
29     }
30
31     private void demo2Button_Click(object sender, EventArgs e)
32     {
33         // Call DisplayValue passing the expression 3 + 5
34         // as an argument.
35         DisplayValue(3 + 5);
36     }
37
38     private void demo3Button_Click(object sender, EventArgs e)
39     {
40         // Use a loop to call DisplayValue 5 times.
41         for (int count = 0; count < 5; count++)
42         {
43             DisplayValue(count);
44         }
45     }
46
47     private void exitButton_Click(object sender, EventArgs e)
48     {
49         // Close the form.
50         this.Close();
51     }
52 }
53 }

```

The form has four button controls, and a Click event handler has been written for each one. In addition to the event handlers, the code contains the `DisplayValue` method, which we discussed earlier, in lines 20–23.

If you run the application and click the *Demo 1* button, the `demo1Button_Click` event handler executes. Notice that in line 28 the `DisplayValue` method is called, passing 5 as an argument. This causes a message box to appear showing the value 5.

If you click the *Demo 2* button, the `demo2Button_Click` event handler executes. In line 35 the `DisplayValue` method is called, passing the expression `3 + 5` as an argument. This causes a message box to appear showing the value 8.

If you click the *Demo 3* button, the `demo3Button_Click` event handler executes. In line 41 a `for` loop executes five times, each time passing the `count` variable as an argument. This causes a message box to appear five times, showing the values 0 through 4.



**NOTE:** When calling a method and passing a variable as an argument, simply write the variable name inside the parentheses of the method call. Do *not* write the data type of the argument variable in the method call. For example, the following statement causes an error:

```
DisplayValue(int x); // Error!
```

The method call should appear as follows:

```
DisplayValue(x); // Correct
```





**NOTE:** In this text, the values that are passed into a method are called arguments, and the variables that receive those values are called parameters. There are several variations of these terms in use. In some circles these terms are switched in meaning. Also, some call the arguments *actual parameters* and call the parameters *formal parameters*. Others use the terms *actual argument* and *formal argument*. Regardless of which set of terms you use, it is important to be consistent.

In Tutorial 6-2 you will complete an application that calls a method and passes an argument to it.



VideoNote

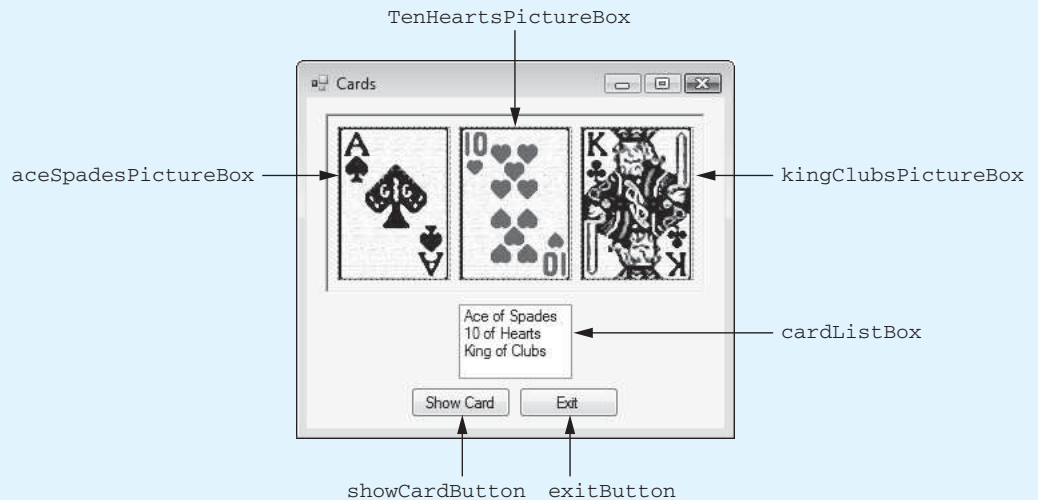
**Tutorial 6-2:**  
Passing an Argument to a Method



## Tutorial 6-2: Passing an Argument to a Method

In this tutorial you complete the *Cards* project in the *Chap06* folder of this book’s Student Sample Programs. The project’s form, shown in Figure 6-12, has already been created for you. The PictureBox controls show the images of three cards. Each PictureBox control’s Visible property is set to False, so they do not initially appear when the application runs. After you complete the application, the user can select a card’s name from the ListBox, click the *Show Card* button, and the image of the selected card will appear.

**Figure 6-12** The *Cards* project’s form



**Step 1:** Start Visual Studio (or Visual Studio Express). Open the project named *Cards* in the *Chap06* folder of this book’s Student Sample Programs.

**Step 2:** Program 6-4, at the end of this tutorial, shows the form’s completed code. Open the code editor and type the comments and code for the `ShowCard` method, shown in lines 20–36 of Program 6-4.

The purpose of the `ShowCard` method is to display one of the card PictureBox controls. Let’s take a closer look at the code.

**Line 22:** This is the beginning of the method. The method has a `string` parameter named `card`. When we call the method, we pass the item that the user selected in the ListBox as an argument, and the method displays the specified card.

**Lines 24–35:** This is a switch statement that tests the value of the card parameter. If `card` is equal to "Ace of Spades", the program jumps to the case statement in line 26 and calls the `ShowAceSpades` method in line 27. If `card` is equal to "10 of Hearts", the program jumps to the case statement in line 29 and calls the `ShowTenHearts` method in line 30. If `card` is equal to "King of Clubs", the program jumps to the case statement in line 32 and calls the `ShowKingClubs` method in line 33.

**Step 3:** Type the comments and code for the `ShowAceSpades` method, shown in lines 38–45 of Program 6-4. This method makes the `aceSpadesPictureBox` control visible, and the other `PictureBox` controls invisible.

**Step 4:** Type the comments and code for the `ShowTenHearts` method, shown in lines 47–54 of Program 6-4. This method makes the `tenHeartsPictureBox` control visible and the other `PictureBox` controls invisible.

**Step 5:** Type the comments and code for the `ShowKingClubs` method, shown in lines 56–63 of Program 6-4. This method makes the `kingClubsPictureBox` control visible, and the other `PictureBox` controls invisible.

**Step 6:** Next you create the Click event handlers for the Button controls. Switch back to the *Designer* and double-click the `showCardButton` control. This opens the code editor, and you will see an empty event handler named `showCardButton_Click`. Complete the `showCardButton_Click` event handler by typing the code shown in lines 67–76 in Program 6-4.

Let's review this code. The `if` statement in line 68 determines whether the user has selected an item in the `cardListBox`. If a value has been selected, line 70 calls the `ShowCard` method. Notice that the item that was selected in the `ListBox` (converted to a string) is passed as an argument. If the user has not selected an item in the `cardListBox` control, the `else` clause in line 72 takes over, and lines 74–75 display a message box telling the user to select a card.

**Step 7:** Switch your view back to the *Designer* and double-click the `exitButton` control. In the code editor you will see an empty event handler named `exitButton_Click`. Complete the `exitButton_Click` event handler by typing the code shown in lines 81–82 in Program 6-4.

**Step 8:** Save the project. Then, press `F5` on the keyboard or click the *Start Debugging* button (🐞) on the toolbar to compile and run the application. Test the application by selecting each card's name in the `ListBox` and clicking the *Show Card* button. When you are finished, click the *Exit* button to exit the application.

---

#### Program 6-4 Completed code for Form1 in the Cards application

```

1 using System;
2 using System.Collections.Generic;
3 using System.ComponentModel;
4 using System.Data;
5 using System.Drawing;
6 using System.Linq;
7 using System.Text;
8 using System.Threading.Tasks;
9 using System.Windows.Forms;
10
11 namespace Cards
12 {
13     public partial class Form1 : Form

```

```

14     {
15     public Form1()
16     {
17         InitializeComponent();
18     }
19
20     // The ShowCard method accepts a string that names
21     // the selected card, and displays that card.
22     private void ShowCard(string card)
23     {
24         switch (card)
25         {
26             case "Ace of Spades" :
27                 ShowAceSpades();
28                 break;
29             case "10 of Hearts":
30                 ShowTenHearts();
31                 break;
32             case "King of Clubs":
33                 ShowKingClubs();
34                 break;
35         }
36     }
37
38     // The ShowAceSpades method makes the Ace of Spades
39     // visible and the other cards invisible.
40     private void ShowAceSpades()
41     {
42         aceSpadesPictureBox.Visible = true;
43         tenHeartsPictureBox.Visible = false;
44         kingClubsPictureBox.Visible = false;
45     }
46
47     // The ShowTenHearts method makes the Ten of Hearts
48     // visible and the other cards invisible.
49     private void ShowTenHearts()
50     {
51         tenHeartsPictureBox.Visible = true;
52         aceSpadesPictureBox.Visible = false;
53         kingClubsPictureBox.Visible = false;
54     }
55
56     // The ShowKingClubs method makes the King of Clubs
57     // visible and the other cards invisible.
58     private void ShowKingClubs()
59     {
60         kingClubsPictureBox.Visible = true;
61         aceSpadesPictureBox.Visible = false;
62         tenHeartsPictureBox.Visible = false;
63     }
64
65     private void showCardButton_Click(object sender, EventArgs e)
66     {
67         // If a card is selected in the ListBox, display it.
68         if (cardListBox.SelectedIndex != -1)
69         {
70             ShowCard(cardListBox.SelectedItem.ToString());
71         }
72         else
73         {

```

```
74         MessageBox.Show("Please select a card from " +
75             "the list box.");
76     }
77 }
78
79 private void exitButton_Click(object sender, EventArgs e)
80 {
81     // Close the form.
82     this.Close();
83 }
84 }
85 }
```

## Argument and Parameter Data Type Compatibility

When you pass an argument to a method, the argument's data type must be assignment compatible with the receiving parameter's data type. Otherwise, an error occurs when you try to compile the code. We discussed assignment compatibility in Chapter 3. Here is a summary of how it applies to argument passing when using strings, ints, doubles, and decimals:

- You can pass only string arguments into string parameters.
- You can pass int arguments into int parameters, but you cannot pass double or decimal arguments into int parameters.
- You can pass either double or int arguments into double parameters, but you cannot pass decimal values into double parameters.
- You can pass either decimal or int arguments to decimal parameters, but you cannot pass double arguments into decimal parameters.

## Parameter Variable Scope

Recall from Chapter 3 that a variable's scope is the part of the program where the variable may be accessed. A variable is visible only to statements inside the variable's scope. A parameter variable's scope is the method in which the parameter is declared. No statement outside the method can access the parameter variable.

## Passing Multiple Arguments

Often it is useful to pass more than one argument to a method. The following code sample shows a method that accepts two arguments. The name of the method is ShowMax. It accepts two int arguments and displays the value of the argument that is the greatest. If the arguments are equal, it displays a message saying so. (This method can be found in the *Max* project in the *Chap06* folder of this book's Student Sample Programs.)

```
1 private void ShowMax(int num1, int num2)
2 {
3     if (num1 == num2)
4     {
5         MessageBox.Show("The numbers are equal.");
6     }
7     else if (num1 > num2)
8     {
9         MessageBox.Show(num1 + " is the greatest.");
```

```

10     }
11     else
12     {
13         MessageBox.Show(num2 + " is the greatest.");
14     }
15 }

```

Notice that two parameter variables, `num1` and `num2`, are declared inside the parentheses in the method header (line 1). This is often referred to as a parameter list. Also notice that a comma separates the declarations. Here is an example of a statement that calls the method:

```
ShowMax(5, 10);
```

This statement passes the arguments 5 and 10 to the method. The arguments are passed into the parameter variables according to their positions. In other words, the first argument is passed into the first parameter variable, the second argument is passed into the second parameter variable, and so forth. So, this statement causes 5 to be passed into the `num1` parameter and 10 to be passed into the `num2` parameter. This is illustrated in Figure 6-13.

**Figure 6-13** Two arguments passed according to position to a method

```

ShowMax(5, 10);

private void ShowMax(int num1, int num2)
{
    if (num1 == num2)
    {
        MessageBox.Show("The numbers are equal.");
    }
    else if (num1 > num2)
    {
        MessageBox.Show(num1 + " is the greatest.");
    }
    else
    {
        MessageBox.Show(num2 + " is the greatest.");
    }
}

```

Suppose we were to reverse the order in which the arguments are listed in the method call, as shown here:

```
ShowMax(10, 5);
```

This causes 10 to be passed into the `num1` parameter and 5 to be passed into the `num2` parameter. The following code sample shows one more example. This time we are passing variables as arguments.

```

int value1 = 2;
int value2 = 3;
ShowMax(value1, value2);

```

When the `ShowMax` method executes as a result of this code, the `num1` parameter contains 2 and the `num2` parameter contains 3.



**NOTE:** You have to write the data type for each parameter variable that is declared in a parameter list. For example, a compiler error would occur if the parameter list for the `ShowMax` method were written as shown here:

```
private void ShowMax(int num1, num2) // Error!
```

A data type for both the `num1` and `num2` parameter variables must be listed, as shown here:

```
private void ShowMax(int num1, int num2)
```

## Named Arguments

In addition to the conventional approach of positional argument passing (where the first argument is passed into the method's first parameter, the second argument is passed into the method's second parameter, and so forth), C# also allows you to specify which parameter an argument should be passed into. To specify which parameter variable the argument should be passed to, you use the following format to write the argument in the method call:

```
parameterName : value
```

In this format *parameterName* is the name of a parameter variable and *value* is the value being passed to that parameter. An argument that is written using this syntax is known as a **named argument**. To demonstrate, look at the following method:

```
private void ShowName(string firstName, string lastName)
{
    MessageBox.Show(firstName + " " + lastName);
}
```

The following statement shows how the method can be called using named arguments:

```
ShowName(lastName : "Smith", firstName : "Suzanne");
```

This statement specifies that "Smith" should be passed into the `lastName` parameter and "Suzanne" should be passed into the `firstName` parameter. You get the same results as if you had called the method like this, using positional arguments:

```
ShowName("Suzanne", "Smith");
```

## Default Arguments

C# allows you to provide a **default argument** for a method parameter. When a default argument is provided for a parameter, it becomes possible to call the method without explicitly passing an argument into the parameter. Here is an example of a method that has a parameter with a default argument:

```
private void ShowTax(decimal price, decimal taxRate = 0.07m)
{
    // Calculate the tax.
    decimal tax = price * taxRate;
    // Display the tax.
    MessageBox.Show("The tax is " + tax.ToString("c"));
}
```

In this method definition, a default argument is provided for the `taxRate` parameter. Notice that the parameter name is followed by an equal sign and a value. The value that follows the equal sign is the default argument. In this case, the value is `0.07m` is the default argument for the `taxRate` parameter. Because the `taxRate` parameter has a default argument, we have the option of omitting an argument for it when we call the method. Here is an example:

```
ShowTax(100.0m);
```

This statement calls the `ShowTax` method, passing the value `100.0m` as the argument for the `price` parameter. Because we did not pass an argument into the `taxRate` parameter, its value will be `0.07m`. If we want the `taxRate` parameter to have a different value, we can specify an argument for it when we call the method, as shown here:

```
ShowTax(100.0m, 0.08m);
```

This statement calls the `ShowTax` method, passing `100.0m` as the argument for the `price` parameter and `0.08m` as the argument for the `taxRate` parameter.

Here are some details to keep in mind when using default arguments:

- Default arguments must be literals or constants. You cannot specify a variable as a default argument.
- You can provide default arguments for all of the parameters in a method. However, when only some of the parameters have a default argument (as in the previous example), you must declare the parameters with the default arguments last. For example, a compiler error would occur if we were to write the `ShowTax` method header as shown here:

```
// Illegal method header!
private void ShowTax(decimal taxRate = 0.07m, decimal price)
```

- When a method has several parameters with default arguments and you leave out one of the arguments when you call the method, you have to leave out all the arguments that come after it as well.



**NOTE:** Default arguments were introduced in Visual C# 2010. You cannot use them in older versions of C#.

## Passing Arguments by Value

All the example programs that you have looked at so far pass arguments by value. Arguments and parameter variables are separate items in memory. When an argument is **passed by value**, only a copy of the argument's value is passed into the parameter variable. If the contents of the parameter variable are changed inside the method, it has no effect on the argument in the calling part of the program.

For example, the following code comes from the *Pass By Value* project in the *Chap06* folder of this book's Student Sample Programs. When you run the application and click the *Go* button, you see the sequence of message boxes shown in Figure 6-14.

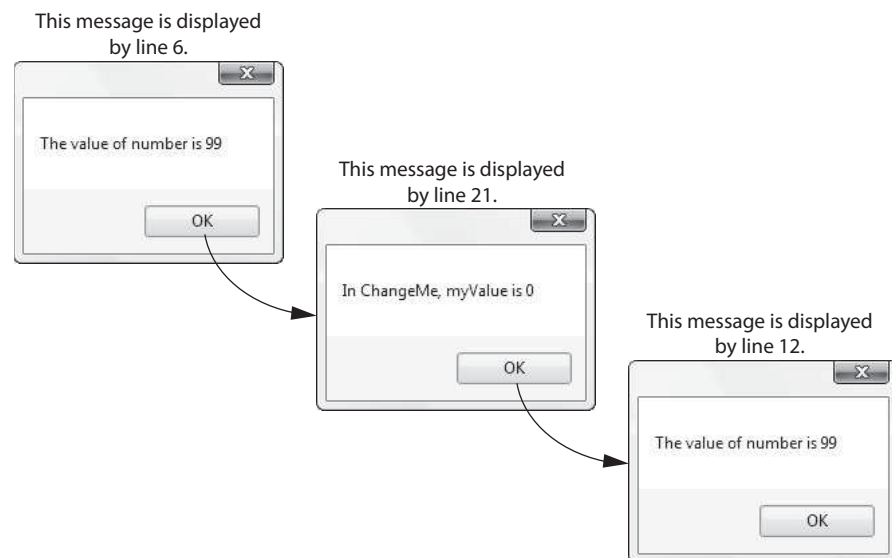
```
1 private void goButton_Click(object sender, EventArgs e)
2 {
3     int number = 99;
4
5     // Display the value of number.
6     MessageBox.Show("The value of number is " + number);
7
8     // Call ChangeMe, passing number as an argument.
9     ChangeMe(number);
```

```

10
11     // Display the value of number again.
12     MessageBox.Show("The value of number is " + number);
13 }
14
15 private void ChangeMe(int myValue)
16 {
17     // Change the value of the myValue parameter.
18     myValue = 0;
19
20     // Display the value of myValue.
21     MessageBox.Show("In ChangeMe, myValue is " + myValue);
22 }

```

**Figure 6-14** Sequence of messages displayed by the *Pass By Value* application



Inside the `goButton_Click` event handler, a local variable named `number` is declared in line 3 and initialized with the value 99. As a result, the statement in line 6 displays *The value of number is 99*. The `number` variable's value is then passed as an argument to the `ChangeMe` method in line 9. This means that in the `ChangeMe` method, the value 99 is assigned to the `myValue` parameter variable.

Inside the `ChangeMe` method, line 18 assigns the value 0 to the `myValue` parameter variable. This overwrites the value 99 that was passed into the parameter when the method was called. Line 21 displays the message *In ChangeMe, myValue is 0*.

After the `ChangeMe` method finishes, control of the program returns to the `goButton_Click` event handler. When the statement in line 12 executes, the message *The value of number is 99* is displayed. Even though the parameter variable `myValue` was changed in the `ChangeMe` method, the `number` variable in the `goButton_Click` event handler was not modified.

Passing by value works in most situations because arguments are usually sent to methods for informational purposes only. Typically, when you pass a variable as an argument to a method, you want that variable to have the same value before *and* after the method call. Passing an argument by value guarantees that the argument will not be changed by the method it is passed into. Sometimes, however, you want a method to be able to change the value of a variable that was passed as an argument to it. This requires a slightly different type of argument passing, which is discussed in the next section.



## Checkpoint

- 6.6 What is the purpose of an argument?
- 6.7 Briefly summarize how assignment compatibility applies to argument passing.
- 6.8 What is the scope of a parameter variable?
- 6.9 What is a named argument?
- 6.10 What does it mean when an argument is passed by value?

## 6.4 Passing Arguments by Reference

**CONCEPT:** When an argument is passed by reference to a method, the method can change the value of the argument in the calling part of the program.

When you want a method to be able to change the value of a variable that is passed to it as an argument, the variable must be **passed by reference**. In C# there are two ways to pass an argument by reference:

- You can use a reference parameter in the method.
- You can use an output parameter in the method.

### Using Reference Parameters

A **reference parameter** is a special type of parameter variable. When you pass an argument into a reference parameter, the reference parameter does not receive a copy of the argument's value. Instead, it becomes a *reference* to the argument that was passed into it. Anything that is done to the reference parameter is actually done to the argument that it references.

Reference parameters are useful for establishing two-way communication between methods. When a method calls another method and passes an argument by reference, communication between the methods can take place in the following ways:

- The calling method can communicate with the called method by passing an argument.
- The called method can communicate with the calling method by modifying the value of the argument via the reference parameter.

In C#, you declare a reference parameter by writing the `ref` keyword before the parameter variable's data type. For example, look at the following method:

```
private void SetToZero(ref int number)
{
    number = 0;
}
```

Inside the parentheses, the keyword `ref` indicates that `number` is a reference variable. The method assigns 0 to the `number` parameter. Because `number` is a reference parameter, this action is actually performed on the variable that was passed to the method as an argument.

When you call a method that has a reference parameter, you must also write the keyword `ref` before the argument. The following code sample shows an example.

```
int myVar = 99;
SetToZero(ref myVar);
```

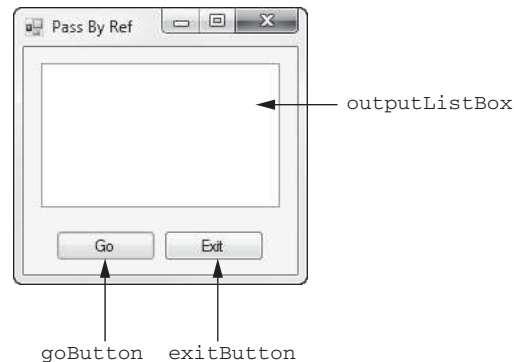
The first statement declares `myVar` as an `int` variable, initialized with the value 99. The second statement calls the `SetToZero` method, passing `myVar` by reference. After the method call, the `myVar` variable is set to the value 0.

When you pass an argument to a `ref` parameter, that argument must already be set to some value. For example, if a variable has not been initialized or assigned a value, you cannot pass it as an argument into a `ref` parameter. The following code sample causes a compiler error:

```
int myVar;           // Declare myVar with no initial value.
SetToZero(ref myVar); // Error! myVar is not set to a value.
```

Let's look at a complete program that uses the `SetToZero` method. In the *Chap06* folder of this book's Student Sample Programs, you will find a project named *Pass By Ref*. Figure 6-15 shows the application's form, and Program 6-5 shows the form's code.

**Figure 6-15** The *Pass By Ref* application's form



**Program 6-5** Code for the *Pass By Ref* application's Form1 form

```
1 using System;
2 using System.Collections.Generic;
3 using System.ComponentModel;
4 using System.Data;
5 using System.Drawing;
6 using System.Linq;
7 using System.Text;
8 using System.Threading.Tasks;
9 using System.Windows.Forms;
10
11 namespace Pass_By_Ref
12 {
13     public partial class Form1 : Form
14     {
15         public Form1()
16         {
17             InitializeComponent();
18         }
19
20         // The SetToZero method accepts an int argument
21         // by reference and sets it to zero.
22         private void SetToZero(ref int number)
23         {
24             number = 0;
25         }
26
```

```

27     private void goButton_Click(object sender, EventArgs e)
28     {
29         // Declare some local int variables.
30         int x = 99, y = 100, z = 101;
31
32         // Display the values in those variables.
33         outputListBox.Items.Clear();
34         outputListBox.Items.Add("x is set to " + x);
35         outputListBox.Items.Add("y is set to " + y);
36         outputListBox.Items.Add("z is set to " + z);
37
38         // Pass each variable to SetToZero.
39         SetToZero(ref x);
40         SetToZero(ref y);
41         SetToZero(ref z);
42
43         // Display the values in those variables again.
44         outputListBox.Items.Add("-----");
45         outputListBox.Items.Add("x is set to " + x);
46         outputListBox.Items.Add("y is set to " + y);
47         outputListBox.Items.Add("z is set to " + z);
48     }
49
50     private void exitButton_Click(object sender, EventArgs e)
51     {
52         // Close the form.
53         this.Close();
54     }
55 }
56 }

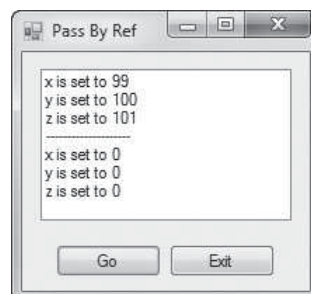
```

Notice that the form has a `ListBox` control named `outputListBox`. This `ListBox` is used to display the program's output. The `SetToZero` method that we previously discussed appears in lines 22–25. The method accepts an `int` argument by reference and assigns the value 0 to the argument.

In the `goButton_Click` method, line 30 declares the `int` variables `x`, `y`, and `z` and initializes them to the values 99, 100, and 101, respectively. Line 33 clears the `outputListBox` control, and lines 34–36 display the values of the `x`, `y`, and `z` variables in the `ListBox`.

In lines 39–41 `x`, `y`, and `z` variables are passed as arguments, by reference, to the `SetToZero` method. Each time `SetToZero` is called, the variable that is passed as an argument is assigned the value 0. This is shown when the `x`, `y`, and `z` variables are displayed again in lines 45–47. Figure 6-16 shows the application's form after the `Go` button has been clicked.

**Figure 6-16** The *Pass By Ref* application's output



## Using Output Parameters

An **output parameter** works like a reference parameter. When you pass an argument into an output parameter, the output parameter becomes a reference to the argument that is passed into it. Anything that is done to the output parameter is actually done to the argument that it references. Output parameters are different from reference parameters in the following ways:

- An argument does not have to be set to a value before it is passed into an output parameter. For example, an uninitialized variable can be passed into an output parameter.
- A method that has an output parameter must set the output parameter to some value before it finishes executing.

In C#, you declare an output parameter by writing the `out` keyword before the parameter variable's data type. For example, we could modify the `SetToZero` method in the following way to make the `number` parameter an output parameter:

```
private void SetToZero(out int number)
{
    number = 0;
}
```

When you call a method that has an output parameter, you must also write the keyword `out` before the argument. The following code sample shows an example.

```
int myVar;
SetToZero(out myVar);
```

The first statement declares `myVar` as an uninitialized `int` variable. The second statement calls the `SetToZero` method, passing `myVar` into the output parameter. After the method call, the `myVar` variable is set to the value 0.

Tutorial 6-3 gives you some experience writing a method that uses an output parameter.



VideoNote

**Tutorial 6-3:**  
Using an  
Output  
Parameter



### Tutorial 6-3: Using an Output Parameter

In this tutorial you complete the *North America* application that is found in the *Chap06* folder of this book's Student Sample Programs. The application's form has already been created and is shown in Figure 6-17. The application also has an accompanying text file named

**Figure 6-17** The *North America* application's form



NorthAmerica.txt that is stored in the *Chap06* folder. The NorthAmerica.txt file contains the names of the countries of North America.

When the completed application runs and the user clicks the *Get Countries* button, the application uses an OpenFileDialog control to let the user select a file. The application reads each country name from the file and adds each one to the countriesListBox control.

**Step 1:** Start Visual Studio (or Visual Studio Express). Open the project named *North America* in the *Chap06* folder of this book's Student Sample Programs.

**Step 2:** Open Form1 in the *Designer* and add an OpenFileDialog control to the form. Change the control's name to `openFile` and clear the contents of the control's `Filename` property.

**Step 3:** Open the Form1 form's code in the code editor. Insert the `using System.IO;` directive shown in line 10 of Program 6-6 at the end of this tutorial. This statement is necessary because you will be using the `StreamReader` class, which is part of the `System.IO` namespace in the .NET Framework.

**Step 4:** Type the comments and code for the `GetFileName` method, shown in lines 21–34 of Program 6-6. The purpose of the `GetFileName` method is to let the user select the file that should be opened. Let's take a closer look at the code.

**Line 24:** This is the beginning of the method. The method has a `string` output parameter named `selectedFile`. When we call the method, we pass a `string` variable as an argument. The method lets the user select the file that should be opened and stores its filename and path in the `selectedFile` parameter.

**Lines 26–33:** This `if` statement calls the `openFile` control's `ShowDialog` method. If the user clicks the *Open* button, the method returns the value `DialogResult.OK`, and line 28 assigns the name of the selected file to the `selectedFile` parameter. If the user clicks the *Cancel* button, line 32 assigns an empty string to the `selectedFile` parameter.

**Step 5:** Type the comments and code for the `GetCountries` method, shown in lines 36–70 of Program 6-6. In a nutshell, this method accepts a filename as an argument, reads the contents of the specified file, and adds them to the `countriesListBox` control. Here is a more detailed description of each part of the method:

**Line 41:** This is the beginning of a `try-catch` statement, which handles any exceptions that are thrown while the file is being processed. If an exception is thrown by any statement in the `try` block, the program will jump to the `catch` clause in line 68.

**Line 44:** This statement declares the `string` variable `countryName`, which holds the lines of text that are read from the file.

**Line 47:** This statement declares the `StreamReader` variable `inputFile`.

**Line 50:** After this statement has executed, the file specified by the `filename` parameter is opened for reading, and the `inputFile` variable references a `StreamReader` object that is associated with the file.

**Line 53:** This statement clears anything that might be displayed in the `countriesListBox` control.

**Line 56:** This is the beginning of a `while` loop that iterates as long as the end of the file has not been reached.

**Line 59:** This statement reads a line of text from the file and assigns it to the `countryName` variable.

**Line 62:** This statement adds the contents of the `countryName` variable to the `ListBox`.

**Line 66:** This statement closes the file.

**Step 6:** Open the `Form1` form in the *Designer*. Double-click the `getCountriesButton` control. This opens the code editor, and you will see an empty event handler named `getCountriesButton_Click`. Complete the `getCountriesButton_Click` event handler by typing the code shown in lines 77–83 in Program 6-6. Let's take a closer look at the code:

**Line 77:** This statement declares a `string` variable named `filename`.

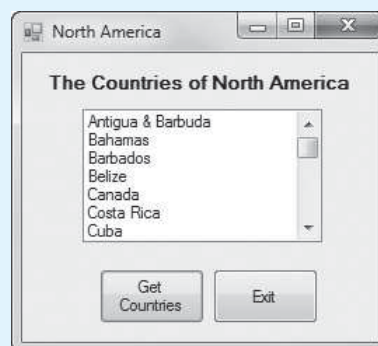
**Line 80:** This statement calls the `GetFileName` method, passing the `filename` variable as an argument. When the method returns, the `filename` variable contains the name of the file selected by the user.

**Line 83:** This statement calls the `GetCountries` method, passing the `filename` variable as an argument. The method opens the specified file and fills the `countriesListBox` control with its contents.

**Step 7:** Switch your view back to the *Designer* and double-click the `exitButton` control. In the code editor you will see an empty event handler named `exitButton_Click`. Complete the `exitButton_Click` event handler by typing the code shown in lines 88–89 in Program 6-6.

**Step 8:** Save the project. Then, press `F5` on the keyboard or click the *Start Debugging* button (🐞) on the toolbar to compile and run the application. When the application runs, click the *Get Countries* button. An *Open* dialog box should appear. Navigate to the `Chap06` folder in the Student Sample Programs, select the `NorthAmerica.txt` file, and click the *Open* button. This should fill the `ListBox` with the names of the countries from the selected file, as shown in Figure 6-18. Click the *Exit* button to exit the application.

**Figure 6-18** The *North America* application displaying the list of countries



**Program 6-6** Completed code for `Form1` in the *North America* application

```

1 using System;
2 using System.Collections.Generic;
3 using System.ComponentModel;
4 using System.Data;
5 using System.Drawing;
6 using System.Linq;
7 using System.Text;
8 using System.Threading.Tasks;

```

```

 9 using System.Windows.Forms;
10 using System.IO;
11
12 namespace North_America
13 {
14     public partial class Form1 : Form
15     {
16         public Form1()
17         {
18             InitializeComponent();
19         }
20
21         // The GetFileName method gets a filename from the
22         // user and assigns it to the variable passed as
23         // an argument.
24         private void GetFileName(out string selectedFile)
25         {
26             if (openFile.ShowDialog() == DialogResult.OK)
27             {
28                 selectedFile = openFile.FileName;
29             }
30             else
31             {
32                 selectedFile = "";
33             }
34         }
35
36         // The GetCountries method accpets a filename as an
37         // argument. It opens the specified file and displays
38         // its contents in the countriesListBox control.
39         private void GetCountries(string filename)
40         {
41             try
42             {
43                 // Declare a variable to hold a country name.
44                 string countryName;
45
46                 // Declare a StreamReader variable.
47                 StreamReader inputFile;
48
49                 // Open the file and get a StreamReader object.
50                 inputFile = File.OpenText(filename);
51
52                 // Clear anything currently in the ListBox.
53                 countriesListBox.Items.Clear();
54
55                 // Read the file's contents.
56                 while (!inputFile.EndOfStream)
57                 {
58                     // Get a country name.
59                     countryName = inputFile.ReadLine();
60
61                     // Add the country name to the ListBox.
62                     countriesListBox.Items.Add(countryName);
63                 }
64
65                 // Close the file.
66                 inputFile.Close();
67             }
68             catch (Exception ex)

```

```

69         {
70             // Display an error message.
71             MessageBox.Show(ex.Message);
72         }
73     }
74
75     private void getCountriesButton_Click(object sender, EventArgs e)
76     {
77         string filename;    // To hold the filename
78
79         // Get the filename from the user.
80         GetFileName(out filename);
81
82         // Get the countries from the file.
83         GetCountries(filename);
84     }
85
86     private void exitButton_Click(object sender, EventArgs e)
87     {
88         // Close the form.
89         this.Close();
90     }
91 }
92 }

```

## Checkpoint

- 6.11 What is a reference parameter?
- 6.12 How can methods communicate using reference parameters?
- 6.13 What keyword is used to specify a reference parameter?
- 6.14 What is an output parameter?

## 6.5 Value-Returning Methods

**CONCEPT:** A value-returning method is a method that returns a value to the part of the program that called it.

A value-returning method is like a `void` method in the following ways:

- It contains a group of statements that perform a specific task.
- When you want to execute the method, you call it.

When a value-returning method finishes, however, it returns a value to the statement that called it. The value that is returned from a method can be used like any other value: It can be assigned to a variable, displayed on the screen, used in a mathematical expression (if it is a number), and so on.

You have already used many of the value-returning methods that are in the .NET Framework. For example, the `int.Parse` method accepts a string as an argument and returns the value of the string converted to an `int`. Let's review how that method works. In the following statement, assume `number` is an `int` variable:

```
number = int.Parse("100");
```



The part of the statement that reads `int.Parse("100")` is a call to the `int.Parse` method, with the string "100" passed as an argument. Figure 6-19 illustrates this part of the statement.

**Figure 6-19** A statement that calls the `int.Parse` method

The diagram shows the code statement `number = int.Parse("100");`. A bracket underneath `int.Parse("100")` is labeled "Method call". An arrow points from the label "Argument" to the string `"100"` inside the parentheses.

Notice that the call to the `int.Parse` method appears on the right side of an `=` operator. When the method is called, it returns an integer. The integer that is returned is assigned to the `number` variable, as shown in Figure 6-20.

**Figure 6-20** The `int.Parse` method returns a value

The diagram shows the code statement `number = int.Parse("100");`. A curved arrow starts from the `int.Parse("100")` part and points to the `number` variable. The number "100" is written above the arrow. Below the code, a caption reads: "The value 100 is returned from the method and assigned to `number`."

## Writing Your Own Value-Returning Functions

You write a value-returning method in the same way that you write a `void` method, with two exceptions:

- You must specify a data type for a value-returning method. The value that is returned from the method must be of the specified data type.
- A value-returning method must have a `return` statement. The `return` statement causes a value to be returned from the method.

Here is the general format of a value-returning method definition in C#:

```
AccessModifier DataType MethodName(ParameterList)
{
    statement;
    statement;
    etc.
    return expression;
}
```

- *AccessModifier* is an access modifier such as `private` or `public`.
- *DataType* is the data type of the value that the method returns. We commonly call this the method's **return type**. For example, if the method returns an integer, the word `int` appears here. If the method returns a `double` value, then the word `double` appears here. Likewise, if the method returns a `decimal` value, the word `decimal` appears here.
- *MethodName* is the name of the method.
- *ParameterList* is an optional parameter list. If the method does not accept arguments, then an empty set of parentheses appears.

One of the statements inside the method must be a `return` statement, which takes the following form:

```
return expression;
```

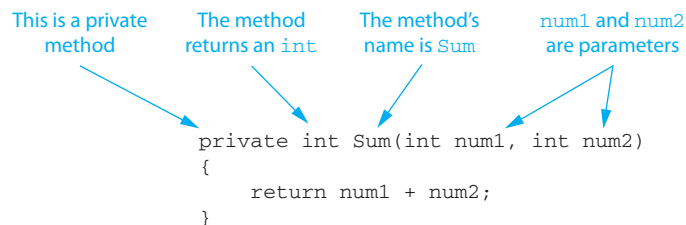
The value of the *expression* that follows the keyword `return` is sent back to the statement that called the method. This can be any value, variable, or expression that has a value (such as a math expression). The value that is returned must be of the same data type as that specified in the method header or a compiler error will occur.

Here is an example of a value-returning method:

```
private int Sum(int num1, int num2)
{
    return num1 + num2;
}
```

Figure 6-21 illustrates the various parts of the method header. Notice that the method returns an `int`, the method's name is `sum`, and the method has two `int` parameters named `num1` and `num2`.

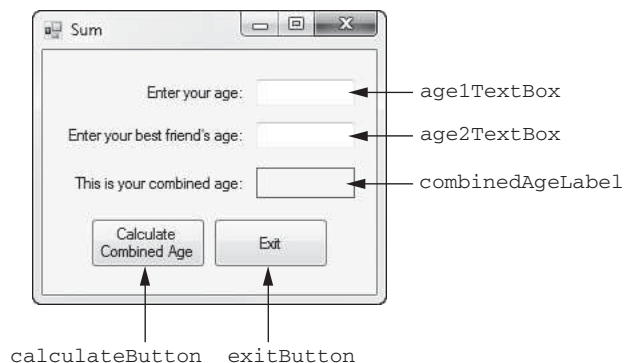
**Figure 6-21** Parts of the method header



The purpose of this method is to accept two `int` values as arguments and return their sum. Notice that the `return` statement returns the value of the expression `num1 + num2`. When the `return` statement executes, the method ends its execution and sends the value of `num1 + num2` back to the part of the program that called the method.

Let's look at a complete program that demonstrates the `Sum` method. In the *Chap06* folder of this book's Student Sample Programs, you will find a project named *Sum*. Figure 6-22 shows the application's form, and Program 6-7 shows the form's code. When you run the application, you enter two integers into the `age1TextBox` and `age2TextBox` controls. When you click the *Calculate Combined Age* button, the sum of the two integers is displayed in the `combinedAgeLabel` control.

**Figure 6-22** The *Sum* application's form



**Program 6-7** Code for the *Sum* application's Form1 form

```

1 using System;
2 using System.Collections.Generic;
3 using System.ComponentModel;
4 using System.Data;
5 using System.Drawing;
6 using System.Linq;
7 using System.Text;
8 using System.Threading.Tasks;
9 using System.Windows.Forms;
10
11 namespace Sum
12 {
13     public partial class Form1 : Form
14     {
15         public Form1()
16         {
17             InitializeComponent();
18         }
19
20         // The Sum method accepts two int arguments
21         // and returns the sum of the arguments.
22         private int Sum(int num1, int num2)
23         {
24             return num1 + num2;
25         }
26
27         private void calculateButton_Click(object sender, EventArgs e)
28         {
29             // Declare variables to hold two ages and their sum.
30             int userAge, friendAge, combinedAge;
31
32             // Get the user's age.
33             if (int.TryParse(age1TextBox.Text, out userAge))
34             {
35                 // Get the best friend's age age.
36                 if (int.TryParse(age2TextBox.Text, out friendAge))
37                 {
38                     // Get the sum of the ages.
39                     combinedAge = Sum(userAge, friendAge);
40
41                     // Display the combined age.
42                     combinedAgeLabel.Text = combinedAge.ToString();
43                 }
44                 else
45                 {
46                     // Display an error message.
47                     MessageBox.Show("Enter an integer for your age.");
48                 }
49             }
50             else
51             {
52                 // Display an error message.
53                 MessageBox.Show("Enter an integer for your age.");
54             }
55         }
56
57         private void exitButton_Click(object sender, EventArgs e)
58         {

```

```

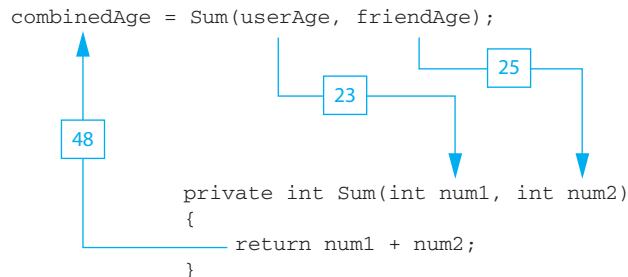
59         // Close the form.
60         this.Close();
61     }
62 }
63 }

```

In line 33, the value entered into the `age1TextBox` control is converted to an `int` and stored in the `userAge` variable. In line 36, the value entered into the `age2TextBox` control is converted to an `int` and stored in the `friendAge` variable. Line 39 passes the `userAge` and `friendAge` variables as arguments to the `Sum` method. The sum of the two variables is returned from the method and assigned to the `combinedAge` variable. In line 42 the value of the `combinedAge` variable is converted to a string and displayed in the `combinedAgeLabel` control.

Let's assume the `userAge` variable is set to the value 23 and the `friendAge` variable is set to the value 25. Figure 6-23 shows how the arguments are passed to the method and how a value is returned from the method.

**Figure 6-23** Arguments passed to `sum` and a value returned



When you call a value-returning method, you usually want to do something meaningful with the value it returns. In line 39 of Program 6-7 the value that is returned from the `Sum` method is assigned to a variable. This is commonly how return values are used, but you can do many other things with them. For example, the following code shows a math expression that uses a call to the `Sum` method:

```

int x = 10, y = 15;
double average;
average = Sum(x, y) / 2.0;

```

In the last statement, the `Sum` method is called with `x` and `y` as its arguments. The method's return value, which is 25, is divided by 2.0. The result, 12.5, is assigned to `average`. Here is another example:

```

int x = 10, y = 15;
MessageBox.Show("The sum is " + Sum(x, y));

```

This code sends the `Sum` method's return value to `MessageBox.Show`, so it can be displayed on the screen. The message *The sum is 25* is displayed. Remember, a value-returning method returns a value of a specific data type. You can use the method's return value anywhere that you can use a regular value of the same data type. This means that anywhere an `int` value can be used, a call to an `int` value-returning method can be used. Likewise, anywhere a `double` value can be used, a call to a `double` value-returning method can be used. The same is true for all other data types.

In Tutorial 6-4 you complete an application that converts a value from one unit of measurement to another. The code will use a value-returning method to perform the conversion.



VideoNote

**Tutorial 6-4:**  
Writing a  
Value-  
Returning  
Method



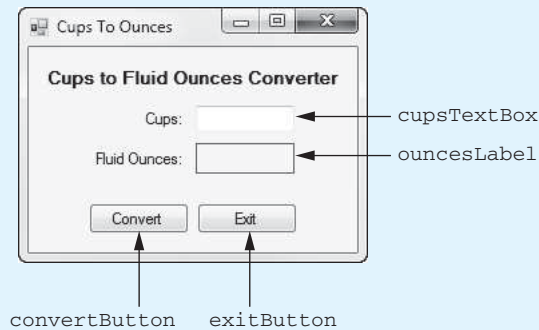
## Tutorial 6-4: Writing a Value-Returning Method

Cups and fluid ounces are common units of measurement for food items. Sometimes, when a recipe calls for an item measured in cups, you find that in the grocery store the item is sold in fluid ounces. To know how much you need to purchase for the recipe, you need to convert the required number of cups to fluid ounces. The formula is:

$$\text{Ounces} = \text{Cups} \times 8$$

In this tutorial you complete the *Cups To Ounces* application that is found in the *Chap06* folder of this book's Student Sample Programs. The application's form has already been created and is shown in Figure 6-24. When you complete the application, you will be able to enter a number of cups into the `cupsTextBox` control, click the *Convert* button, and see the equivalent number of fluid ounces in the `ouncesLabel` control.

**Figure 6-24** The *Cups To Ounces* application's form



- Step 1:** Start Visual Studio (or Visual Studio Express). Open the project named *Cups To Ounces* in the *Chap06* folder of this book's Student Sample Programs.
- Step 2:** Open the `Form1` form in the *Designer*. The form is shown, along with the names of the important controls, in Figure 6-24.
- Step 3:** Program 6-8, at the end of this tutorial, shows the form's completed code. Open the code editor and type the comments and code for the `CupsToOunces` method shown in lines 20–26 of Program 6-8. The purpose of the method is to accept a number of cups as an argument and return that value converted to fluid ounces. You can see in line 23 that the method has a `double` parameter named `cups`, and in line 25 the method returns the value of `cups` multiplied by 8.
- Step 4:** Now you will create the Click event handlers for the Button controls. Switch back to the *Designer* and double-click the `convertButton` control. This opens the code editor, and you will see an empty event handler named `convertButton_Click`. Complete the `convertButton_Click` event handler by typing the code shown in lines 30–46 in Program 6-8. Let's review this code:
- Line 31:** This statement declares the `cups` and `ounces` variables, which hold the number of cups and ounces.
- Lines 34–46:** The `if` statement in line 34 converts the `cupsTextBox` control's `Text` property to a `double`, and the result is stored in the `cups` variable. If the

conversion is successful, line 37 calls the `CupsToOunces` method, passing `cups` as an argument. The value that is returned from the method is assigned to the `ounces` variable, and in line 40 the value of the `ounces` variable is displayed in the `ouncesLabel` control. If the conversion is not successful, line 45 displays an error message.

**Step 5:** Switch your view back to the *Designer* and double-click the `exitButton` control. In the code editor you will see an empty event handler named `exitButton_Click`. Complete the `exitButton_Click` event handler by typing the code shown in lines 51–52 in Program 6-8.

**Step 6:** Save the project. Then, press `F5` on the keyboard, or click the *Start Debugging* button (▶) on the toolbar to compile and run the application. When the application runs, enter the value 1 into the `cupsTextBox` control and click the *Convert* button. The application should display 8.0 as the number of fluid ounces. Continue to test the application with other values. When you are finished, click the *Exit* button to exit the application.

---

#### Program 6-8 Completed code for Form1 in the *Cups To Ounces* application

```

1 using System;
2 using System.Collections.Generic;
3 using System.ComponentModel;
4 using System.Data;
5 using System.Drawing;
6 using System.Linq;
7 using System.Text;
8 using System.Threading.Tasks;
9 using System.Windows.Forms;
10
11 namespace Cups_To_Ounces
12 {
13     public partial class Form1 : Form
14     {
15         public Form1()
16         {
17             InitializeComponent();
18         }
19
20         // The CupsToOunces method accepts a number
21         // of cups as an argument and returns the
22         // equivalent number of fluid ounces.
23         private double CupsToOunces(double cups)
24         {
25             return cups * 8.0;
26         }
27
28         private void convertButton_Click(object sender, EventArgs e)
29         {
30             // Variables to hold cups and ounces
31             double cups, ounces;
32
33             // Get the number of cups.
34             if (double.TryParse(cupsTextBox.Text, out cups))
35             {
36                 // Convert the cups to ounces.
37                 ounces = CupsToOunces(cups);

```

```

38
39         // Display the ounces.
40         ouncesLabel.Text = ounces.ToString("n1");
41     }
42     else
43     {
44         // Display an error message.
45         MessageBox.Show("Enter a valid number.");
46     }
47 }
48
49 private void exitButton_Click(object sender, EventArgs e)
50 {
51     // Close the form.
52     this.Close();
53 }
54 }
55 }

```

## Boolean Methods

A Boolean method returns either `true` or `false`. You can use a Boolean method to test a condition, and then return either `true` or `false` to indicate whether the condition exists. Boolean methods are useful for simplifying complex conditions that are tested in decision and repetition structures.

For example, suppose you are writing a program that will ask the user to enter a number and then determine whether that number is even or odd. The following code shows how you can make that determination. Assume `number` is an `int` variable containing the number entered by the user.

```

if (number % 2 == 0)
{
    MessageBox.Show("The number is even.");
}
else
{
    MessageBox.Show("The number is odd.");
}

```

The meaning of the Boolean expression being tested by this `if-else` statement is not clear, so let's take a closer look at it:

```
number % 2 == 0
```

This expression uses the `%` operator, which was introduced in Chapter 2. Recall that the `%` operator divides two integers and returns the remainder of the division. So, this code is saying, If the remainder of `number` divided by 2 is equal to 0, then display a message indicating the number is even, or else display a message indicating the number is odd.

Because dividing an even number by 2 always gives a remainder of 0, this logic works. The code would be easier to understand, however, if you could somehow rewrite it to say, If the number is even, then display a message indicating it is even, or else display a message indicating it is odd. As it turns out, this can be done with a Boolean method. In this example, you could write a Boolean method named `IsEven` that accepts an `int` as an

argument and returns `true` if the number is even or `false` otherwise. Here is an example how the `IsEven` method might be written:

```
private bool IsEven(int number)
{
    // Local variable to hold true or false
    bool numberIsEven;
    // Determine whether the number is even.
    if (number % 2 == 0)
    {
        numberIsEven = true;
    }
    else
    {
        numberIsEven = false;
    }
    // Return the result.
    return numberIsEven;
}
```

Then you can rewrite the `if-else` statement so it calls the `IsEven` method to determine whether `number` is even:

```
if (IsEven(number))
{
    MessageBox.Show("The number is even.");
}
else
{
    MessageBox.Show("The number is odd.");
}
```

Not only is this logic easier to understand, but now you have a method that you can call in the program any time you need to test a number to determine whether it is even. (The *Chap06* folder of this book's Student Sample Programs has a project named *Even Number* that demonstrates the `IsEven` method.)

## Using a Boolean Method to Modularize Input Validation

Boolean methods can be useful for modularizing input validation. When a form has multiple `TextBox` controls, the input validation usually requires multiple, nested `if` statements. In many cases, you can simplify the code by creating a Boolean method that performs all the input validation and returns `true` if all of the input is valid or `false` if any of it is invalid. In Tutorial 6-5 you will complete an application that uses this approach.



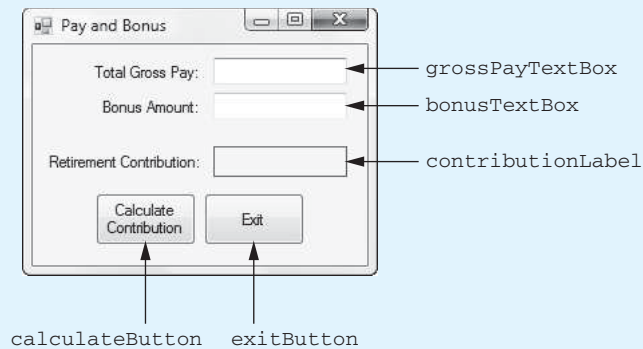
VideoNote

**Tutorial 6-5:**  
Modularizing Input Validation with a Boolean Method

### Tutorial 6-5: Modularizing Input Validation with a Boolean Method

In addition to regular pay, a company pays its employees an annual bonus. The company also contributes 5 percent of an employee's total compensation (gross pay plus bonus) to a retirement account. In this tutorial you complete an application that lets you enter an employee's gross pay and bonus amount and calculates the amount of retirement contribution. The project is named *Pay and Bonus* and is found in the *Chap06* folder of this book's Student Sample Programs. Figure 6-25 shows the application's form, which has already been created for you.



**Figure 6-25** The *Pay and Bonus* application's form

**Step 1:** Start Visual Studio (or Visual Studio Express). Open the project named *Pay and Bonus* in the *Chap06* folder of this book's Student Sample Programs.

**Step 2:** Open the Form1 form's code in the code editor. Insert the comment and constant field declaration shown in lines 15 and 16 of Program 6-9. This constant, which is set to the value 0.05, is used in the calculation of the retirement account contribution.

**Step 3:** Type the comments and code for the `InputIsValid` method, shown in lines 23 through 54 of Program 6-9. Notice in line 27 that the method has reference parameters for gross pay and the bonus amount. The purpose of the method is to get the values entered by the user, convert them to `decimal` values, and assign them to the parameter variables. If the input is successfully converted, the method returns `true`. Otherwise, an error message is displayed and the method returns `false` to indicate that the input is not valid.

**Step 4:** Open the Form1 form in the *Designer*. Double-click the `calculateButton` control. This opens the code editor, and you will see an empty event handler named `calculateButton_Click`. Complete the `calculateButton_Click` event handler by typing the code shown in lines 58–68 in Program 6-9. Let's take a closer look at the code:

**Line 59:** This statement declares `decimal` variables to hold the gross pay, bonus amount, and contribution amount.

**Lines 61–68:** This `if` statement calls the `InputIsValid` method, passing the `grosspay` and `bonus` variables, by reference, as arguments. If the method returns `true`, the variables will contain the gross pay and bonus amount entered by the user. In that case, line 64 calculates the amount of contribution to the retirement account, and line 67 displays that amount.

**Step 5:** Switch your view back to the *Designer* and double-click the `exitButton` control. In the code editor you will see an empty event handler named `exitButton_Click`. Complete the `exitButton_Click` event handler by typing the code shown in lines 73–74 in Program 6-9.

**Step 6:** Save the project. Then, press `(F5)` on the keyboard or click the *Start Debugging* button (🐞) on the toolbar to compile and run the application. When the application runs, enter 80000 for the gross pay and 20000 for the bonus amount. Click the *Calculate Contribution* button. The application should display \$5,000.00 as the amount of contribution. Try other values if you wish. Click the *Exit* button to exit the application.

**Program 6-9** Completed code for Form1 in the *Pay and Bonus* application

```

1 using System;
2 using System.Collections.Generic;
3 using System.ComponentModel;
4 using System.Data;
5 using System.Drawing;
6 using System.Linq;
7 using System.Text;
8 using System.Threading.Tasks;
9 using System.Windows.Forms;
10
11 namespace Pay_and_Bonus
12 {
13     public partial class Form1 : Form
14     {
15         // Constant field for the contribution rate
16         private const decimal CONTRIB_RATE = 0.05m;
17
18         public Form1()
19         {
20             InitializeComponent();
21         }
22
23         // The InputIsValid method converts the user input and stores
24         // it in the arguments (passed by reference). If the conversion
25         // is successful, the method returns true. Otherwise it returns
26         // false.
27         private bool InputIsValid(ref decimal pay, ref decimal bonus)
28         {
29             // Flag variable to indicate whether the input is good
30             bool inputGood = false;
31
32             // Try to convert both inputs to decimal.
33             if (decimal.TryParse(grossPayTextBox.Text, out pay))
34             {
35                 if (decimal.TryParse(bonusTextBox.Text, out bonus))
36                 {
37                     // Both inputs are good.
38                     inputGood = true;
39                 }
40                 else
41                 {
42                     // Display an error message for the bonus.
43                     MessageBox.Show("Bonus amount is invalid.");
44                 }
45             }
46             else
47             {
48                 // Display an error message for gross pay.
49                 MessageBox.Show("Gross pay is invalid.");
50             }
51
52             // Return the result.
53             return inputGood;
54         }
55
56         private void calculateButton_Click(object sender, EventArgs e)
57         {

```

```

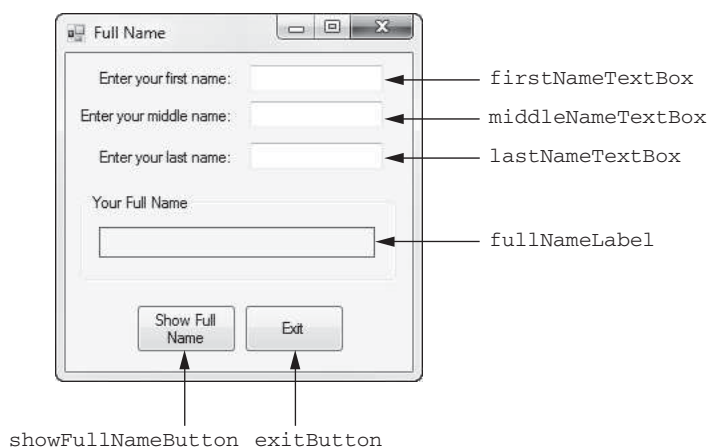
58         // Variables for gross pay, bonus, and contributions
59         decimal grossPay = 0m, bonus = 0m, contributions = 0m;
60
61         if (InputIsValid(ref grossPay, ref bonus))
62         {
63             // Calculate the amount of contribution.
64             contributions = (grossPay + bonus) * CONTRIB_RATE;
65
66             // Display the contribution.
67             contributionLabel.Text = contributions.ToString("c");
68         }
69     }
70
71     private void exitButton_Click(object sender, EventArgs e)
72     {
73         // Close the form.
74         this.Close();
75     }
76 }
77 }

```

## Returning a String from a Method

So far you've seen examples of methods that return numbers and Boolean values. You can write methods that return any type of data. Let's look at an example program that uses a string-returning method. The *Chap06* folder of this book's Student Sample Programs contains a project named *Full Name*. Figure 6-26 shows the application's form, and Program 6-10 shows the form's code. When you run the application, you enter your first name, middle name, and last name into the TextBox controls. When you click the *Show Full Name* button, your full name is displayed in the `fullNameLabel` control.

**Figure 6-26** The *Full Name* application's form



**Program 6-10** Code for the *Full Name* application's Form1 form

```

1 using System;
2 using System.Collections.Generic;
3 using System.ComponentModel;
4 using System.Data;

```

```

5 using System.Drawing;
6 using System.Linq;
7 using System.Text;
8 using System.Threading.Tasks;
9 using System.Windows.Forms;
10
11 namespace Full_Name
12 {
13     public partial class Form1 : Form
14     {
15         public Form1()
16         {
17             InitializeComponent();
18         }
19
20         // The FullName method accepts arguments for a first
21         // name, a middle name, and a last name. It returns
22         // the full name.
23         private string FullName(string first, string middle, string last)
24         {
25             return first + " " + middle + " " + last;
26         }
27
28         private void showFullNameButton_Click(object sender, EventArgs e)
29         {
30             // Variables to hold the first, middle, last, and full names
31             string first, middle, last, full;
32
33             // Get the first, middle, and last names.
34             first = firstNameTextBox.Text;
35             middle = middleNameTextBox.Text;
36             last = lastNameTextBox.Text;
37
38             // Get the full name.
39             full = FullName(first, middle, last);
40
41             // Display the full name.
42             fullNameLabel.Text = full;
43         }
44
45         private void exitButton_Click(object sender, EventArgs e)
46         {
47             // Close the form.
48             this.Close();
49         }
50     }
51 }

```

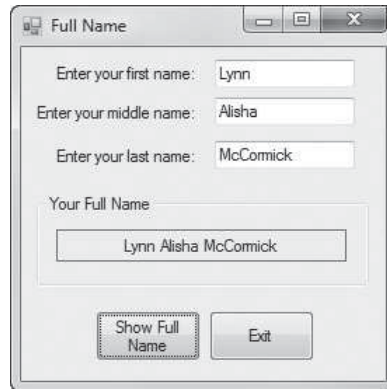
Lines 23–26 define a method named `FullName`. Notice the following things about the method:

- Its return type is `string`.
- It has three `string` parameters: `first`, `middle`, and `last`. When we call the method we pass a first name, a middle name, and a last name as arguments.
- In line 25 it returns a string that is the concatenation of the `first`, `middle`, and `last` parameters, with spaces inserted between each.

Figure 6-27 shows an example of the application's form after the user has entered names into each `TextBox` and clicked the *Show Full Name* button.

**Figure 6-27** Example output of the *Full Name* application

---



 **Checkpoint**

- 6.15 What is a value-returning method? How is it used?
- 6.16 What is returned by a Boolean method?
- 6.17 Can a method be written to return any type of data?

## Key Terms

arguments	Pascal case
code reuse	passed by reference
default argument	passed by value
divide and conquer	reference parameter
method body	return point
method header	return type
modularized program	stepwise refinement
named argument	top-down design
output parameter	value-returning method
parameter	void method
parameter variable	

## Review Questions

### Multiple Choice

- In general terms, a program that is broken into smaller units of code, such as methods, is known as a(n) \_\_\_\_\_.
  - object-oriented program
  - modularized program
  - procedural program
  - method-driven program
- Writing the code to perform a task once and then reusing it each time you need to perform the task is a benefit of using methods called \_\_\_\_\_.
  - code reuse
  - the single-use philosophy
  - method recycling
  - code reprocessing
- When you call a(n) \_\_\_\_\_, it simply executes the statements it contains and then terminates.
  - intrinsic method
  - empty method
  - logical method
  - void method
- The \_\_\_\_\_, which appears at the beginning of a method definition, lists several important things about the method, including the method's name.
  - method title
  - method description
  - method header
  - method declaration
- The \_\_\_\_\_ is a collection of statements enclosed inside a set of curly braces that are performed when the method is executed.
  - method body
  - method designation
  - method code
  - method classification
- The \_\_\_\_\_ is the memory address that is saved by the system when a method is called and is the location to which the system should return after a method ends.
  - calling address
  - method address

- c. return point
  - d. come back position
7. Programmers commonly use a technique known as \_\_\_\_\_ to break down an algorithm into methods.
    - a. prototyping
    - b. method modeling
    - c. algorithm division
    - d. top-down design
  8. Pieces of data that are sent into a method are known as \_\_\_\_\_.
    - a. arguments
    - b. references
    - c. method variables
    - d. data entries
  9. A(n) \_\_\_\_\_ is a special variable that receives an argument when a method is called.
    - a. reference variable
    - b. argument variable
    - c. parameter variable
    - d. method variable
  10. A \_\_\_\_\_ specifies which parameter an argument should be passed into.
    - a. named argument
    - b. special argument
    - c. constant argument
    - d. literal argument
  11. When a(n) \_\_\_\_\_ is provided for a parameter, it becomes possible to call the method without explicitly passing an argument into the parameter.
    - a. local argument
    - b. empty argument
    - c. default argument
    - d. expressional argument
  12. When an argument is \_\_\_\_\_, only a copy of the argument's value is passed into the parameter variable.
    - a. a named constant
    - b. passed by association
    - c. passed by reference
    - d. passed by value
  13. When you want a method to be able to change the value of a variable that is passed to it as an argument, the variable must be \_\_\_\_\_.
    - a. passed by reference
    - b. a local variable
    - c. passed by value
    - d. a named constant
  14. A \_\_\_\_\_ a special type of parameter variable that is useful for establishing two-way communication between methods.
    - a. communication variable
    - b. reference parameter
    - c. method parameter
    - d. global variable

15. A(n) \_\_\_\_\_ can have an uninitialized value passed into it, but it must be set to some value before the method it belongs to finishes executing.
  - a. input parameter
  - b. reference parameter
  - c. output parameter
  - d. default parameter
16. A method's \_\_\_\_\_ is the type of value that the method returns.
  - a. data type
  - b. return type
  - c. value type
  - d. method type

### True or False

1. Dividing a large problem into several smaller problems that are easily solved is sometimes called divide and conquer.
2. In a Pascal case name, the first character is always uppercase.
3. If a method belongs to a class, then you must write a method's definition inside the class.
4. The contents of variables and the values of expressions cannot be passed as arguments.
5. You do not have to write the data type for each parameter variable that is declared in a parameter list if they are all of the same data type.
6. An output parameter works like a by value parameter.
7. A value-returning function must contain a `return` statement.
8. A Boolean method returns either `yes` or `no`.

### Short Answer

1. What do you call a method that executes the statements it contains and then returns a value back to the statement that called it?
2. What is the standard naming convention used among C# programmers for method names? Why?
3. What is another name for the top-down design process?
4. What is a parameter list?
5. How do you specify a named argument?
6. How are output parameters different from reference parameters?
7. How is a value-returning method like a `void` method? How is it different?
8. Can Boolean methods be used to modularize input validation? Why or why not?

### Algorithm Workbench

1. Examine the following method header; then write an example call to the method.
 

```
private void ShowValue()
```
2. The following statement calls a method named `ShowHalf`. The `ShowHalf` method displays a value that is half that of the argument. Write the method.
 

```
ShowHalf(50);
```



- Write the method header for a method named `ShowRetailPrice`. The method should include parameter variables for a list price and a markup percentage. Write the method so that the default argument for the markup percentage is set to 50 percent.
- Examine the following method header; then write an example call to the method.

```
private void ResetValue(ref int value)
```

- A program contains the following value-returning method.

```
private int Square(int value)
{
    return value * value;
}
```

Write a statement that passes the value 10 as an argument to this method and assigns its return value to the variable `result`.

## Programming Problems

### 1. Retail Price Calculator

Create an application that lets the user enter an item's wholesale cost and its markup percentage. It should then display the item's retail price. For example:

- If an item's wholesale cost is \$5.00 and its markup percentage is 100 percent, then the item's retail price is \$10.00.
- If an item's wholesale cost is \$5.00 and its markup percentage is 50 percent, then the item's retail price is \$7.50.

The program should have a method named `CalculateRetail` that receives the wholesale cost and the markup percentage as arguments and returns the retail price of the item.

### 2. Falling Distance

When an object is falling because of gravity, the following formula can be used to determine the distance the object falls in a specific time period:

$$d = \frac{1}{2}gt^2$$

The variables in the formula are as follows:  $d$  is the distance in meters,  $g$  is 9.8, and  $t$  is the amount of time in seconds that the object has been falling. Create an application that allows the user to enter the amount of time that an object has fallen and then displays the distance that the object fell. The application should have a function named `FallingDistance`. The `FallingDistance` function should accept an object's falling time (in seconds) as an argument. The function should return the distance in meters that the object has fallen during that time interval.

### 3. Kinetic Energy

In physics, an object that is in motion is said to have kinetic energy. The following formula can be used to determine a moving object's kinetic energy:

$$KE = \frac{1}{2}mv^2$$

In the formula  $KE$  is the kinetic energy,  $m$  is the object's mass in kilograms, and  $v$  is the object's velocity in meters per second. Create an application that allows the user to enter an object's mass and velocity and then displays the object's kinetic energy. The application should have a function named `KineticEnergy` that accepts an object's mass (in kilograms) and velocity (in meters per second) as arguments. The function should return the amount of kinetic energy that the object has.



VideoNote

Solving the  
Kinetic  
Energy  
problem

#### 4. Calories from Fat and Carbohydrates

A nutritionist who works for a fitness club helps members by evaluating their diets. As part of her evaluation, she asks members for the number of fat grams and carbohydrate grams that they consume in a day. Then, she calculates the number of calories that result from the fat using the following formula:

$$\text{Calories from fat} = \text{Fat grams} \times 9$$

Next, she calculates the number of calories that result from the carbohydrates using the following formula:

$$\text{Calories from carbs} = \text{Carbs grams} \times 4$$

Create an application that will make these calculations. In the application, you should have the following methods:

- **FatCalories**—This method should accept a number of fat grams as an argument and return the number of calories from that amount of fat.
- **CarbCalories**—This method should accept a number of carbohydrate grams as an argument and return the number of calories from that amount of carbohydrates.

#### 5. Joe's Automotive

Joe's Automotive performs the following routine maintenance services:

- Oil change—\$26.00
- Lube job—\$18.00
- Radiator flush—\$30.00
- Transmission flush—\$80.00
- Inspection—\$15.00
- Muffler replacement—\$100.00
- Tire rotation—\$20.00

Joe also performs other nonroutine services and charges for parts and labor (\$20 per hour). Create an application that displays the total for a customer's visit to Joe's. The form should resemble the one shown in Figure 6-28.

**Figure 6-28** Automotive form

The application should have the following value-returning methods:

- `OilLubeCharges`—Returns the total charges for an oil change and/or a lube job, if any.
- `FlushCharges`—Returns the total charges for a radiator flush and/or a transmission flush, if any.
- `MiscCharges`—Returns the total charges for an inspection, muffler replacement, and/or a tire rotation, if any.
- `OtherCharges`—Returns the total charges for other services (parts and labor), if any.
- `TaxCharges`—Returns the amount of sales tax, if any. Sales tax is 6% and is charged only on parts. If the customer purchases services only, no sales tax is charged.
- `TotalCharges`—Returns the total charges.

The application should have the following `void` methods, called when the user clicks the *Clear* button:

- `ClearOilLube`—Clears the check boxes for oil change and lube job.
- `ClearFlushes`—Clears the check boxes for radiator flush and transmission flush.
- `ClearMisc`—Clears the check boxes for inspection, muffler replacement, and tire rotation.
- `ClearOther`—Clears the text boxes for parts and labor.
- `ClearFees`—Clears the labels that display the labels in the section marked *Summary*.

## 6. Hospital Charges

Create an application that calculates the total cost of a hospital stay. The daily base charge is \$350. The hospital also charges for medication, surgical fees, lab fees, and physical rehab. The application should accept the following input:

- The number of days spent in the hospital
- The amount of medication charges
- The amount of surgical charges
- The amount of lab fees
- The amount of physical rehabilitation charges

Create and use the following value-returning methods in the application:

- `CalcStayCharges`—Calculates and returns the base charges for the hospital stay. This is computed as \$350 times the number of days in the hospital.
- `CalcMiscCharges`—Calculates and returns the total of the medication, surgical, lab, and physical rehabilitation charges.
- `CalcTotalCharges`—Calculates and returns the total charges.

## 7. Present Value

Suppose you want to deposit a certain amount of money into a savings account and then leave it alone to draw interest for the next 10 years. At the end of 10 years you would like to have \$10,000 in the account. How much do you need to deposit today to make that happen? You can use the following formula, which is known as the present-value formula, to find out:

$$P = \frac{F}{(1 + r)^n}$$

The terms in the formula are as follows:

- $P$  is the *present value*, or the amount that you need to deposit today.
- $F$  is the *future value* that you want in the account. (In this case,  $F$  is \$10,000.)

- $r$  is the *annual interest rate*.
- $n$  is the *number of years* that you plan to let the money sit in the account.

Write a method named `PresentValue` that performs this calculation. The method should accept the future value, annual interest rate, and number of years as arguments. It should return the present value, which is the amount that you need to deposit today. Demonstrate the method in an application that lets the user experiment with different values for the formula's terms.

## 8. Prime Numbers

A prime number is a number that can be evenly divided by only itself and 1. For example, the number 5 is prime because it can be evenly divided by only 1 and 5. The number 6, however, is not prime because it can be evenly divided by 1, 2, 3, and 6. Write a Boolean function named `IsPrime` that takes an integer as an argument and returns `true` if the argument is a prime number or `false` otherwise. Use the function in an application that lets the user enter a number and then displays a message indicating whether the number is prime.



**TIP:** Recall that the `%` operator divides one number by another and returns the remainder of the division. In an expression such as `num1 % num2`, the `%` operator returns 0 if `num1` is evenly divisible by `num2`.

## 9. Prime Number List

This exercise assumes you have already written the `IsPrime` function in Programming Problem 8. Create another application that uses this function to display all the prime numbers from 1 through 100 in a list box. The program should have a loop that calls the `IsPrime` function.

## 10. Rock, Paper, Scissors Game

Create an application that lets the user play the game of Rock, Paper, Scissors against the computer. The program should work as follows.

1. When the program begins, a random number in the range of 1 through 3 is generated. If the number is 1, then the computer has chosen rock. If the number is 2, then the computer has chosen paper. If the number is 3, then the computer has chosen scissors. (Do not display the computer's choice yet.)
2. The user selects his or her choice of rock, paper, or scissors. To get this input you can use `Button` controls, or clickable `PictureBox` controls displaying some of the artwork that you will find in the student sample files.
3. The computer's choice is displayed.
4. A winner is selected according to the following rules:
  - If one player chooses rock and the other player chooses scissors, then rock wins. (Rock smashes scissors.)
  - If one player chooses scissors and the other player chooses paper, then scissors wins. (Scissors cuts paper.)
  - If one player chooses paper and the other player chooses rock, then paper wins. (Paper wraps rock.)
  - If both players make the same choice, the game must be played again to determine the winner.

Be sure to modularize the program into methods that perform each major task.

*This page intentionally left blank*

## TOPICS

- |     |  |     |  |
|-----|--|-----|--|
| 7.1 | Value Types and Reference Types        | 7.6 | Advanced Algorithms for Sorting and Searching Arrays |
| 7.2 | Array Basics                           | 7.7 | Two-Dimensional Arrays                               |
| 7.3 | Working with Files and Arrays          | 7.8 | Jagged Arrays  |
| 7.4 | Passing Arrays as Arguments to Methods | 7.9 | The <code>List</code> Collection                     |
| 7.5 | Some Useful Array Algorithms           |     |  |

## 7.1

## Value Types and Reference Types

**CONCEPT:** The data types in C# and the .NET Framework fall into two categories: value types and reference types.

In this chapter you will gain more experience working with objects. Specifically, you will work with arrays and collections, which are objects that store groups of data. Before we go into the details of creating and working with those objects, it will be helpful for you to understand how objects are stored in memory. In this section we discuss the ways that different types of objects are internally stored by the .NET Framework. As a result, you will better understand the concepts presented in this chapter, and chapters to come.

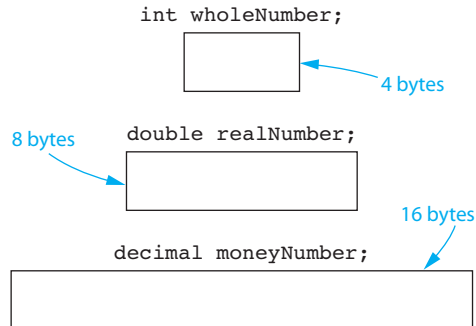
All the data types in C#—and the underlying .NET Framework—fall into two categories: **value types** and **reference types**. Of the C# data types that you have used so far, the following are value types: `int`, `double`, `decimal`, and `bool`. (There are other value types in addition to these, but these are the ones we focus on in this book.)

When you declare a value type variable, the compiler sets aside, or allocates, a chunk of memory that is big enough for that variable. For example, look at the following variable declarations:

```
int wholeNumber;  
double realNumber;  
decimal moneyNumber;
```

Recall from Chapter 3 that an `int` uses 32 bits of memory (4 bytes), a `double` uses 64 bits of memory (8 bytes), and a `decimal` uses 128 bits of memory (16 bytes). These declaration statements cause memory to be allocated as shown in Figure 7-1.

**Figure 7-1** Memory allocated

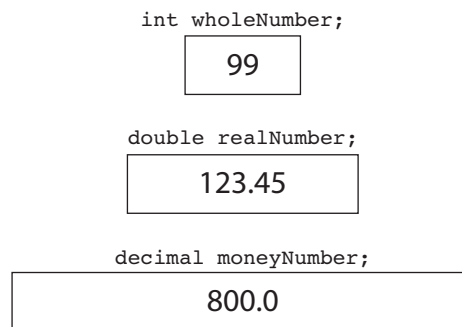


The memory that is allocated for a value type variable is the actual location that will hold any value that is assigned to that variable. For example, suppose we use the following statements to assign values to the variables shown in Figure 7-1:

```
wholeNumber = 99;
realNumber = 123.45;
moneyNumber = 800.0m;
```

Figure 7-2 shows how the assigned values are stored in each variable's memory location.

**Figure 7-2** Values assigned to the variables



As you can see from these illustrations, value types are very straightforward. When you are working with a value type, you are using a variable that holds a piece of data.

This is different from the way that reference types work. When you are working with a reference type, you are using two things:

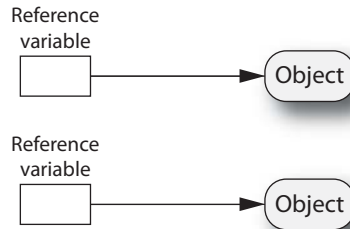
- An object that is created in memory
- A variable that references the object

The object that is created in memory holds data of some sort and performs operations of some sort. (Exactly what the data and operations are depends on what kind of object it is.) In order to work with the object in code, you need some way to refer to it. That's where the variable comes in. The variable does not hold an actual piece of data with which your program will work. Instead, it holds a special value known as a **reference**, which links the variable to the object.<sup>1</sup> When you want to work with the object, you use the variable that references it.

<sup>1</sup>A reference is similar to a memory address. It is a value that identifies the object's memory location.

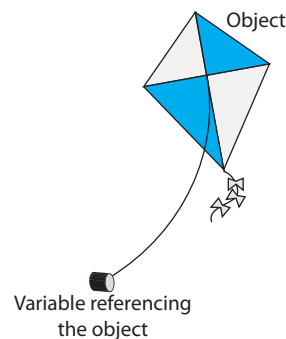
A variable that is used to reference an object is commonly called a **reference variable**. Reference variables can be used only to reference objects. Figure 7-3 illustrates two objects that have been created in memory, each referenced by a variable.

**Figure 7-3** Two objects referenced by variables



To understand how reference variables and objects work together, think about flying a kite. In order to fly a kite, you need a spool of string attached to it. When the kite is airborne, you use the spool of string to hold onto the kite and control it. This is similar to the relationship between an object and the variable that references the object. As shown in Figure 7-4, the object is like the kite, and the variable that references the object is like the spool of string.

**Figure 7-4** The kite and string metaphor



Creating a reference type object typically requires the following two steps:

1. You declare a reference variable.
2. You create the object and associate it with the reference variable.

After you have performed these steps, you can use the reference variable to work with the object. Let's look at an example that you have already learned about: creating objects of the `Random` class. Recall from Chapter 5 that the `Random` class allows your program to generate random numbers. Here is an example of how you create an object from the `Random` class:

```
Random rand = new Random();
```

Let's look at the different parts of this statement:

- The first part of the statement, appearing on the left side of the `=` operator, reads `Random rand`. This declares a variable named `rand` that can be used to reference an object of the `Random` type.
- The second part of the statement, appearing on the right side of the `=` operator, reads `new Random()`. The **new operator** creates an object in memory and returns a

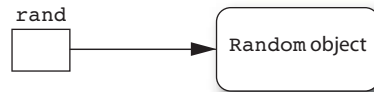


reference to that object. So, the expression `new Random()` creates an object from the `Random` class and returns a reference to that object.

- The `=` operator assigns the reference that was returned from the `new` operator to the `rand` variable.

After this statement executes, the `rand` variable references a `Random` object, as shown in Figure 7-5. The `rand` variable can then be used to perform operations with the object, such as generating random numbers.

**Figure 7-5** The `rand` variable referencing a `Random` object



## Checkpoint

- 7.1 Into what two categories do the data types in C# and the underlying .NET Framework fall?
- 7.2 What is the difference in the way you work with value types and reference types?
- 7.3 How is the relationship between an object and a reference variable similar to a kite and a spool of string?
- 7.4 Is a variable of the `Random` class a reference type or a value type?

## 7.2 Array Basics

**CONCEPT:** An array allows you to store a group of items of the same data type together in memory. Processing a large number of items in an array is usually easier than processing a large number of items stored in separate variables.

In the programs you have written so far, you have used variables to store data in memory. The simplest way to store a value in memory is to store it in a variable. Variables work well in many situations, but they have limitations. For example, they can hold only one value at a time. Consider the following variable declaration:

```
int number = 99;
```

This statement declares an `int` variable named `number`, initialized with the value 99. Consider what happens if the following statement appears later in the program:

```
number = 5;
```

This statement assigns the value 5 to `number`, replacing the value 99 that was previously stored there. Because `number` is an ordinary variable, it can hold only one value at a time.

Because variables hold only a single value, they can be cumbersome in programs that process lists of data. For example, suppose you are asked to write a program that holds the names of 50 employees. Imagine declaring 50 variables to hold all those names:

```
string employee1;
string employee2;
string employee3;
```

and so on . . .

```
string employee50
```

Then, imagine writing the code to process all 50 names. For example, if you wanted to display the contents of the variables in a `ListBox`, you would write code such as this:

```
employeeListBox.Items.Add(employee1); // Display employee 1
employeeListBox.Items.Add(employee2); // Display employee 2
employeeListBox.Items.Add(employee3); // Display employee 3
```

and so on . . .

```
employeeListBox.Items.Add(employee50); // Display employee 50
```

As you can see, variables are not well suited for storing and processing lists of data. Each variable is a separate item that must be declared and individually processed.

Fortunately, you can use an array as an alternative to a group of variables. An **array** is an object that can hold a group of values that are all the same data type. You can have an array of `int` values, an array of `double` values, and array of `decimal` values, or an array of `string` values, but you cannot store a mixture of data types in an array. Once you create an array, you can write simple and efficient code to process the values that are stored in it.

Arrays are reference type objects. Recall from Section 7.1 that two steps are required to create and use a reference type object:

1. You declare a reference variable.
2. You create the object and associate it with the reference variable.

Suppose you want to create an array that can hold `int` values. Here is an example of how you might declare a reference variable for the array:

```
int[] numbersArray;
```

This statement declares a reference variable named `numbersArray`. Notice that this statement looks like a regular `int` variable declaration except for the set of brackets ( `[]` ) that appear after the keyword `int`. The expression `int[]` indicates that this variable is a reference to an `int` array. So, we cannot use this variable to store an `int` value. Rather, we can use it to reference an `int` array.

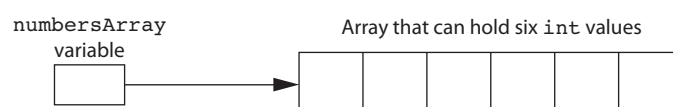
The next step in the process is to create the array object and associate it with the `numbersArray` variable. The following statement shows an example:

```
numbersArray = new int[6];
```

As previously mentioned, the `new` keyword creates an object in memory. The expression that appears after the `new` keyword specifies what type of object to create. In this case, the expression `int[6]` specifies that the object should be an array large enough to hold six `int` values. The number inside the brackets is the array's **size declarator**. It indicates the number of values that the array should be able to hold.

The `new` keyword also returns a reference to the object that it creates. In the previously shown statement, the `new` keyword creates an `int` array and returns a reference to that array. The `=` operator assigns the reference to the `numbersArray` variable. After this statement executes, the `numbersArray` variable will reference an `int` array that can hold six values. This is shown in Figure 7-6.

**Figure 7-6** The `numbersArray` variable referencing an `int` array



In the previous example we used two statements to (1) declare a reference variable and (2) create an array object. These two steps can be combined into one statement, as shown here:

```
int[] numbersArray = new int[6];
```

You can create arrays of any data. The following are all valid array declarations:

```
double[] temperatures = new double[100];
decimal[] prices = new decimal[50];
string[] nameArray = new string[1200];
```

An array's size declarator must be a nonnegative integer expression. It can be a literal value, as shown in the previous examples, or a variable. It is a preferred practice to use a named constant as a size declarator, however. Here is an example:

```
const int SIZE = 6;
int[] numbersArray = new int[SIZE];
```

This practice can make programs easier to maintain. As you will see later in this chapter, many array-processing techniques require you to refer to the array's size. When you use a named constant as an array's size declarator, you can use the constant to refer to the size of the array in your algorithms. If you ever need to modify the program so the array is a different size, you need only change the value of the named constant.

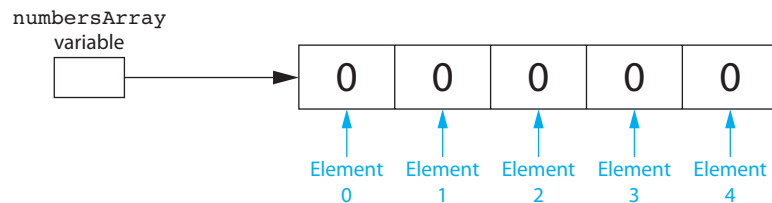
## Array Elements and Subscripts

The storage locations in an array are known as **elements**. In memory, an array's elements are located in consecutive memory locations. Each element in an array is assigned a unique number known as a **subscript**. Subscripts are used to identify specific elements in an array. The first element is assigned the subscript 0, the second element is assigned the subscript 1, and so forth. For example, suppose a program has the following declarations:

```
const int SIZE = 5;
int[] numbersArray = new int[SIZE];
```

As shown in Figure 7-7, the array referenced by `numbersArray` has five elements. The elements are assigned the subscripts 0–4. (Because subscript numbering starts at 0, the subscript of the last element in an array is 1 less than the total number of elements in the array.)

**Figure 7-7** Array subscripts



## Array Element Default Values

Notice that Figure 7-7 shows each element of the array containing the value 0. When you create a numeric array in C#, its elements are set to the value 0 by default.

Remember, you can create an array to hold any type of value. It is possible to create an array of reference type objects. If you create an array of reference type objects, each element of the array acts as a reference variable. By default, the elements of an array of reference type objects are set to the special value `null`. The value `null` indicates that a reference variable is not set to a valid object and cannot be used for any meaningful purpose.



**NOTE:** As you will see in Chapter 8, strings are actually reference types, so the default value of a `string` array's elements is `null`.

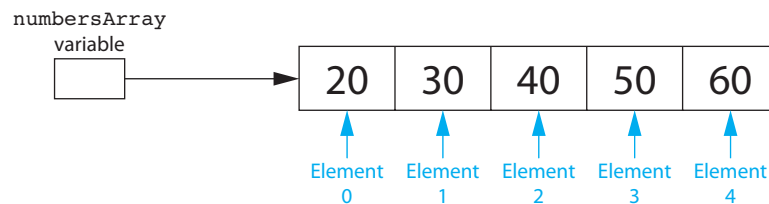
## Working with Array Elements

You access the individual elements in an array by using their subscripts. For example, the following code creates an `int` array with five elements and assigns values to each of its elements.

```
const int SIZE = 5;
int[] numbersArray = new int[SIZE];
numbersArray[0] = 20;
numbersArray[1] = 30;
numbersArray[2] = 40;
numbersArray[3] = 50;
numbersArray[4] = 60;
```

This code assigns the value 20 to element 0, the value 30 to element 1, and so forth. Figure 7-8 shows the contents of the array after these statements execute.

**Figure 7-8** Values assigned to each element



**NOTE:** The expression `numbersArray[0]` is pronounced “numbersArray sub zero.”

The following code shows another example. It creates a `string` array with three elements and assigns strings to each of its elements.

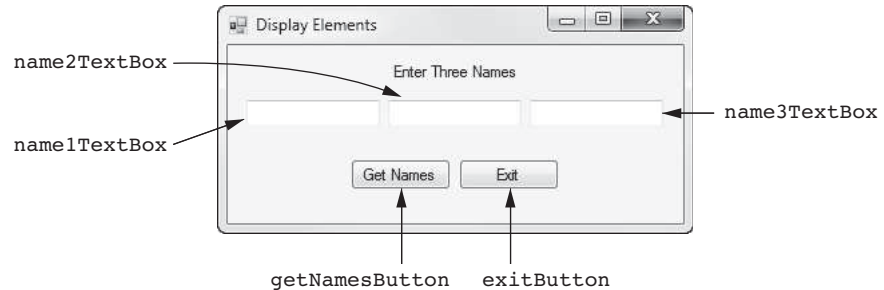
```
const int SIZE = 3;
string[] names = new string[SIZE];
names[0] = "Chris";
names[1] = "Laurie";
names[2] = "Joe";
```

The following code sample shows how values can be assigned from `TextBox` controls to array elements. Assume that an application's form has three `TextBox` controls named `amount1TextBox`, `amount2TextBox`, and `amount3TextBox` and that the user has entered a numeric value into each one. The following code creates a `decimal` array named `amounts` and assigns each of the `TextBox` control's input value to an array element.

```
const int SIZE = 3;
decimal[] amounts = new decimal[SIZE];
amounts[0] = decimal.Parse(amount1TextBox.Text);
amounts[1] = decimal.Parse(amount2TextBox.Text);
amounts[2] = decimal.Parse(amount3TextBox.Text);
```

Let's look at a complete program that demonstrates how to assign values to an array and then display the values in the array. In the *Chap07* folder of this book's Student Sample Programs, you will find a project named *Display Elements*. Figure 7-9 shows the application's form.

**Figure 7-9** The *Display Elements* application's form



Here is the code for the `getNamesButton_Click` event handler:

```

1 private void getNamesButton_Click(object sender, EventArgs e)
2 {
3     // Create an array to hold three strings.
4     const int SIZE = 3;
5     string[] names = new string[SIZE];
6
7     // Get the names.
8     names[0] = name1TextBox.Text;
9     names[1] = name2TextBox.Text;
10    names[2] = name3TextBox.Text;
11
12    // Display the names.
13    MessageBox.Show(names[0]);
14    MessageBox.Show(names[1]);
15    MessageBox.Show(names[2]);
16 }

```

Run the application, enter a name into each of the `TextBox` controls, and then click the *Get Names* button. The following actions take place:

- In line 5, an array to hold three strings is created.
- In lines 8–10, the names that you entered into the `TextBox` controls are assigned to the array elements.
- In lines 13–15, each element of the array is displayed in a message box.

The *Display Elements* application displays the contents of a `string` array. Because the array's elements are strings, we can pass each element directly to the `MessageBox.Show` method without performing a data type conversion. If you want to pass a numeric array element to the `MessageBox.Show` method, however, you will have to call the element's `ToString` method. The following code sample demonstrates:

```

1 // Create an array to hold three integers.
2 const int SIZE = 3;
3 int[] myValues = new int[SIZE];
4
5 // Assign some values to the array elements.
6 myValues[0] = 10;
7 myValues[1] = 20;
8 myValues[2] = 30;
9

```

```

10 // Display the array elements.
11 MessageBox.Show(myValues[0].ToString());
12 MessageBox.Show(myValues[1].ToString());
13 MessageBox.Show(myValues[2].ToString());

```

## Array Initialization

When you create an array, you can optionally initialize it with a group of values. Here is an example:

```

const int SIZE = 5;
int[] numbersArray = new int[SIZE] { 10, 20, 30, 40, 50 };

```

The series of values inside the braces and separated with commas is called an **initialization list**. These values are stored in the array elements in the order they appear in the list. (The first value, 10, is stored in `numbersArray[0]`, the second value, 20, is stored in `numbersArray[1]`, and so forth.)

When you provide an initialization list, the size declarator can be left out. The compiler determines the size of the array from the number of items in the initialization list. Here is an example:

```

int[] numbersArray = new int[] { 10, 20, 30, 40, 50 };

```

In this example, the compiler determines that the array should have five elements because five values appear in the initialization list.

You can also leave out the `new` operator and its subsequent expression when an initialization list is provided. Here is an example:

```

int[] numbersArray = { 10, 20, 30, 40, 50 };

```

Here are three separate examples that declare and initialize a `string` array named `days`. Each of these examples results in the same array:

```

// Example 1
const int SIZE = 7;
string[] days = new string[SIZE] = { "Sunday", "Monday",
                                     "Tuesday", "Wednesday", "Thursday",
                                     "Friday", "Saturday" };

// Example 2
string[] days = new string[] = { "Sunday", "Monday",
                                  "Tuesday", "Wednesday", "Thursday",
                                  "Friday", "Saturday" };

// Example 3
string[] days = { "Sunday", "Monday", "Tuesday",
                  "Wednesday", "Thursday", "Friday",
                  "Saturday" };

```

## Using a Loop to Step through an Array

You can store a number in an `int` variable and then use that variable as a subscript. This makes it possible to use a loop to step through an array, performing the same operation on each element. For example, look at the following code sample:

```

1 // Create an array to hold three integers.
2 const int SIZE = 3;
3 int[] myValues = new int[SIZE];
4
5 // Assign 99 to each array element.
6 for (int index = 0; index < SIZE; index++)

```

```

7 {
8     myValues[index] = 99;
9 }

```

Line 3 creates an `int` array named `myValues` with three elements. The `for` loop that starts in line 6 uses an `int` variable named `index` as its counter. The `index` variable is initialized with the value 0 and is incremented after each loop iteration. The loop iterates as long as `index` is less than 3. So, the loop will iterate three times. As it iterates, the `index` variable is assigned the values 0, 1, and 2.

Inside the loop, the statement in line 8 assigns the value 99 to an array element, using the `index` variable as the subscript. This is what happens as the loop iterates:

- The first time the loop iterates, `index` is set to 0, so 99 is assigned to `myValues[0]`.
- The second time the loop iterates, `index` is set to 1, so 99 is assigned to `myValues[1]`.
- The third time the loop iterates, `index` is set to 2, so 99 is assigned to `myValues[2]`.

## Invalid Subscripts

When working with an array, it is important that you do not use an invalid subscript. You cannot use a subscript that is less than 0 or greater than the size of the array minus 1. For example, suppose an array has 100 elements. The valid subscripts for the array are the integers 0 through 99. If you try to use any value outside this range, an exception will be thrown at runtime. The following code sample demonstrates how a loop that is not carefully written can cause such an exception to be thrown:

```

1 // Create an array to hold three integers.
2 const int SIZE = 3;
3 int[] myValues = new int[SIZE];
4
5 // Will this loop cause an exception?
6 for (int index = 0; index <= SIZE; index++)
7 {
8     myValues[index] = 99;
9 }

```

Notice that the `for` loop iterates as long as `index` is less than *or equal to* 3. During the loop's last iteration, `index` is set to 3, so the statement in line 8 attempts to make an assignment to `myValues[3]`. There is no element in the array with the subscript 3, so an exception will be thrown.

## The Length Property

In C#, all arrays have a **Length** property that is set to the number of elements in the array. For example, consider an array created by the following statement:

```
double[] temperatures = new double[25];
```

The `temperatures` array's `Length` property will be set to 25. If we executed the following statement, it would display the message "The temperatures array has 25 elements."

```
MessageBox.Show("The temperatures array has " +
    temperatures.Length + " elements.");
```

The `Length` property can be useful when processing the entire contents of an array with a loop. The subscript of the last element is always 1 less than the array's `Length` property. Here is an example:

```
for (int index = 0; index < temperatures.Length; index++)
{
    MessageBox.Show(temperatures[index].ToString());
}
```



**NOTE:** An array's `Length` property is read only, so you cannot change its value.

In Tutorial 7-1 you complete an application that generates a set of random numbers similar to those used in lotteries. The numbers will be stored in an array.



## Tutorial 7-1: Using an Array to Hold a List of Random Lottery Numbers

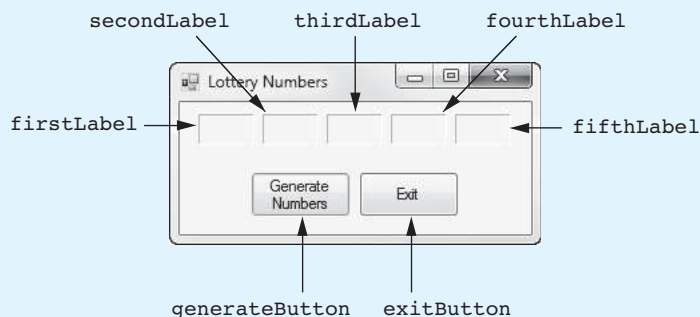


VideoNote

**Tutorial 7-1:**  
Using an  
Array to  
Hold a List  
of Random  
Lottery  
Numbers

In this tutorial you complete an application that randomly generates lottery numbers. The application's form is shown in Figure 7-10. When the *Generate Numbers* button is clicked, the application will generate five two-digit integer numbers and store them in an array. The contents of the array will then be displayed in Label controls.

**Figure 7-10** The *Lottery Numbers* application's form



**Step 1:** Start Visual Studio (or Visual Studio Express). Open the project named *Lottery Numbers* in the *Chap07* folder of this book's Student Sample Programs.

**Step 2:** Open the `Form1` form in the *Designer*. Double-click the `generateButton` control. This will open the code editor, and you will see an empty event handler named `generateButton_Click`. Complete the `generateButton_Click` event handler by typing the code shown in lines 22–41 in Program 7-1. Let's take a closer look at the code:

**Line 23:** This statement declares an `int` constant named `SIZE`, set to the value 5. This is used as an array size declarator.

**Line 24:** This statement creates an `int` array named `lotteryNumbers` with five elements.

**Line 27:** This statement creates a `Random` object, referenced by a variable named `rand`.

**Line 31:** This `for` loop uses an `int` variable named `index` as its counter. The `index` variable is initialized with the value 0 and is incremented after each loop iteration. The loop iterates as long as `index` is less than `lotteryNumbers.Length` (which is 5). So, the loop will iterate five times. As it iterates, the `index` variable is assigned the values 0, 1, 2, 3, and 4.


**Line 33:** This statement gets a random number in the range of 0 through 99 and assigns it to `lotteryNumbers[index]`. The first time the loop iterates,



this statement assigns a random number to `lotteryNumbers[0]`. The second time the loop iterates, this statement assigns a random number to `lotteryNumbers[1]`. This continues until the loop is finished. At that time, each element in the array is assigned a random number.

**Lines 37–41:** These statements display the array elements in the `firstLabel`, `secondLabel`, `thirdLabel`, `fourthLabel`, and `fifthLabel` controls.

**Step 3:** Switch your view back to the *Designer* and double-click the `exitButton` control. In the code editor you will see an empty event handler named `exitButton_Click`. Complete the `exitButton_Click` event handler by typing the code shown in lines 46–47 in Program 7-1.

**Step 4:** Save the project. Then, press `[F5]` on the keyboard, or click the *Start Debugging* button  on the toolbar to compile and run the application. When the application runs, click the *Generate Numbers* button. The application should display a set of random numbers in the Label controls. Click the *Generate Numbers* button several more times to see different sets of random numbers. When you are finished, click the *Exit* button to exit the application.

---

#### Program 7-1 Completed code for Form1 in the *Lottery Numbers* application

```

1 using System;
2 using System.Collections.Generic;
3 using System.ComponentModel;
4 using System.Data;
5 using System.Drawing;
6 using System.Linq;
7 using System.Text;
8 using System.Threading.Tasks;
9 using System.Windows.Forms;
10
11 namespace Lottery_Numbers
12 {
13     public partial class Form1 : Form
14     {
15         public Form1()
16         {
17             InitializeComponent();
18         }
19
20         private void generateButton_Click(object sender, EventArgs e)
21         {
22             // Create an array to hold the numbers.
23             const int SIZE = 5;
24             int[] lotteryNumbers = new int[SIZE];
25
26             // Create a Random object.
27             Random rand = new Random();
28
29             // Fill the array with random numbers, in the range
30             // of 0 through 99.
31             for (int index = 0; index < lotteryNumbers.Length; index++)
32             {
33                 lotteryNumbers[index] = rand.Next(100);
34             }
35
36             // Display the array elements in the Label controls.
37             firstLabel.Text = lotteryNumbers[0].ToString();

```

```

38         secondLabel.Text = lotteryNumbers[1].ToString();
39         thirdLabel.Text = lotteryNumbers[2].ToString();
40         fourthLabel.Text = lotteryNumbers[3].ToString();
41         fifthLabel.Text = lotteryNumbers[4].ToString();
42     }
43
44     private void exitButton_Click(object sender, EventArgs e)
45     {
46         // Close the form.
47         this.Close();
48     }
49 }
50 }

```

## Watching for Off-by-One Errors

Because array subscripts start at 0 rather than 1, you have to be careful not to perform an off-by-one error. An **off-by-one error** occurs when a loop iterates one time too many or one time too few. For example, look at the following code sample:

```

1 // Create an array to hold three integers.
2 const int SIZE = 100;
3 int[] myValues = new int[SIZE];
4
5 // Assign 99 to each array element.
6 for (int index = 1; index < myValues.Length; index++)
7 {
8     myValues[index] = 99;
9 }

```

The intent of this code is to create an `int` array with 100 elements and assign the value 99 to each element. However, this code has an off-by-one error. During the loop's execution, the `index` variable is assigned the values 1 through 99 when it should be assigned the values 0 through 99. As a result, the first element, which is at subscript 0, is skipped.

## Using the `foreach` Loop with Arrays

C# provides a special loop that, in many circumstances, simplifies array processing. It is known as the **`foreach` loop**. When you use the `foreach` loop with an array, the loop automatically iterates once for each element in the array. For example, if you use the `foreach` loop with an eight-element array, the loop will iterate eight times. Because the `foreach` loop automatically knows the number of elements in an array, you do not have to use a counter variable to control its iterations, as with a regular `for` loop.

The `foreach` loop is designed to work with a temporary, read-only variable known as the **iteration variable**. Each time the `foreach` loop iterates, it copies an array element to the iteration variable. For example, the first time the loop iterates, the iteration variable will contain the value of element 0, the second time the loop iterates, the iteration variable will contain the value of element 1, and so forth.

Here is the general format of the `foreach` loop:

```

foreach(Type VariableName in ArrayName)
{
    statement;
    statement;
    etc.
}

```

The statements that appear inside the curly braces are the body of the loop. These are the statements executed each time the loop iterates. As with other control structures, the curly braces are optional if the body of the loop contains only one statement, as shown in the following general format:

```
foreach(Type VariableName in ArrayName)
    statement;
```

Let's take a closer look at the items appearing inside the parentheses:

- *Type* is the data type of the values in the array.
- *VariableName* is the name of the iteration variable.
- *in* is a keyword that must appear after the *VariableName*.
- *ArrayName* is the name of an array.

Suppose we have the following array declaration:

```
int[] numbers = { 3, 6, 9 };
```

We can use the following `foreach` loop to display the contents of the `numbers` array:

```
foreach (int val in numbers)
{
    MessageBox.Show(val.ToString());
}
```

Because the `numbers` array has three elements, this loop will iterate three times. The first time it iterates, `val` will contain the value of `numbers[0]`, so a message box will display the value 3. During the second iteration, `val` will contain the value of `numbers[1]`, so a message box will display the value 6. During the third iteration, `val` will contain the value of `numbers[2]`, so a message box will display the value 9.

### The foreach Loop versus the for Loop

When you need to read the values that are stored in an array from the first element to the last element, the `foreach` loop is simpler to use than the `for` loop. With the `foreach` loop, you do not have to be concerned about the size of the array, and you do not have to create a counter variable to hold subscripts. However, because the iteration variable is read only, there are circumstances in which the `foreach` loop is not adequate. You cannot use the `foreach` loop if you need to do any of the following:

- Change the contents of an array element
- Work through the array elements in reverse order
- Access some, but not all, of the array elements
- Simultaneously work with two or more arrays within the loop

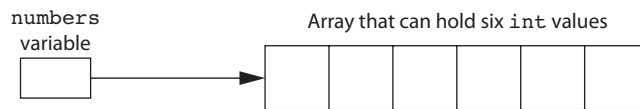
In any of these circumstances, you should use the `for` loop to process the array.

## Reassigning an Array Reference Variable

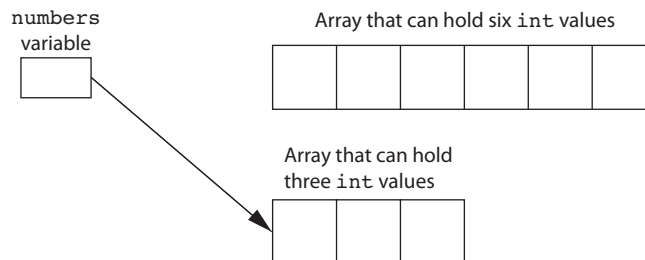
It is possible to reassign an array reference variable to a different array, as demonstrated by the following code sample:

```
1 // Create an array referenced by the numbers variable.
2 int[] numbers = new int[6];
3
4 // Reassign the numbers variable to a new array.
5 numbers = new int[3];
```

The statement in line 2 creates a six-element `int` array. A reference to the array is assigned to the `numbers` variable. Figure 7-11 shows how the `numbers` variable references the six-element array after this statement executes.

**Figure 7-11** The `numbers` variable referencing a six-element array

Then, the statement in line 5 creates a new, three-element `int` array. A reference to the new array is assigned to the `numbers` variable. When line 5 executes, the reference that is currently stored in the `numbers` variable will be replaced by a reference to the three-element array. After this statement executes, the `numbers` variable will reference the three-element array instead of the six-element array. This is illustrated in Figure 7-12.

**Figure 7-12** The `numbers` variable referencing a three-element array

Notice in Figure 7-12 that the six-element array still exists in memory, but it is no longer referenced by any variables. Because it is no longer referenced, it cannot be accessed. When an object is no longer referenced, it becomes eligible for garbage collection. **Garbage collection** is a process that periodically runs, removing all unreferenced objects from memory.

## Checkpoint

- 7.5 Write a statement that declares a reference variable named `monthlyPay` for an array that can hold `decimal` values.
- 7.6 Write a statement so that the `monthlyPay` variable from Checkpoint 7.5 references a `decimal` array that can hold 12 values.
- 7.7 Combine the statements from Checkpoints 7.5 and 7.6 into a single statement, and use a named constant for a size declarator.
- 7.8 Write a statement that creates an array of 3 `string` values referenced by a variable named `fullName`. Provide an initialization list for the array using string values for a first, middle, and last name.
- 7.9 Under what circumstances should you use a `for` loop rather than a `foreach` loop to process data stored in an array?
- 7.10 What happens when an object such as an array is no longer referenced by a variable?

## 7.3 Working with Files and Arrays

**CONCEPT:** For some problems, files and arrays can be used together effectively. You can easily write a loop that saves the contents of an array to a file, and vice versa.

Some tasks may require you to save the contents of an array to a file so the data can be used at a later time. Likewise, some situations may require you to read the data from a file into an array. For example, suppose you have a file that contains a set of values and you want to reverse the order of the values. One technique for doing this is to read the file's values into an array and then write the values in the array back to the file from the end of the array to the beginning.

### Writing an Array's Contents to a File

Writing the contents of an array to a file is a straightforward procedure: Open the file and use a loop to step through each element of the array, writing its contents to the file. For example, in the *Chap07* folder of the Student Sample Programs, you will find a project named *Array To File*. When you click the OK button, the application writes the contents of an `int` array to a file. The following code shows the Click event handler for the OK button.

```

1 private void okButton_Click(object sender, EventArgs e)
2 {
3     try
4     {
5         // Create an array with some values.
6         int[] numbers = { 10, 20, 30, 40, 50 };
7
8         // Declare a StreamWriter variable.
9         StreamWriter outputFile;
10
11        // Create the file and get a StreamWriter object.
12        outputFile = File.CreateText("Values.txt");
13
14        // Write the array's contents to the file.
15        for (int index = 0; index < numbers.Length; index++)
16        {
17            outputFile.WriteLine(numbers[index]);
18        }
19
20        // Close the file.
21        outputFile.Close();
22
23        // Let the user know it's done.
24        MessageBox.Show("Done");
25    }
26    catch (Exception ex)
27    {
28        // Display an error message.
29        MessageBox.Show(ex.Message);
30    }
31 }

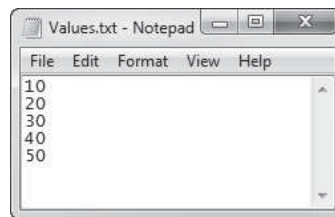
```

The `try-catch` statement handles any file-related errors. Here is a summary of the code inside the `try` block:

- Line 6 creates an `int` array with five elements, initialized to the values 10, 20, 30, 40, and 50.
- Line 9 declares a `StreamWriter` variable named `outputFile`. (You do not see it in this code sample, but the directive using `System.IO`; appears at the top of the file. This is required for the `StreamWriter` declaration in line 9.)
- Line 12 creates a file named `Values.txt` for writing. After this statement executes, the `outputFile` variable will reference a `StreamWriter` object that is associated with the file.
- Line 15 is the beginning of a `for` loop. The loop iterates once for each element of the array. During the loop's iterations, the `index` variable will be assigned the values 1, 2, 3, 4 and 5.
- Inside the loop, line 17 writes the array element `numbers[index]` to the file.
- Line 21 closes the file.
- Line 24 displays a message box letting the user know the operation is done.

Figure 7-13 shows the contents of the `Values.txt` file, opened in Notepad, after the `OK` button has been clicked.

**Figure 7-13** Contents of the `Values.txt` file



## Reading Values from a File and Storing Them in an Array

Reading the contents of a file into an array is also straightforward: Open the file and use a loop to read each item from the file, storing each item in an array element. The loop should iterate until either the array is filled or the end of the file is reached. For example, in the *Chap07* folder of the Student Sample Programs, you will find a project named *File To Array*. When you click the *Get Values* button, the application reads values from a file named `Values.txt` into an `int` array. The contents of the array are then displayed in a list box. The following code shows the `Click` event handler for the *Get Values* button.

```

1 private void getValuesButton_Click(object sender, EventArgs e)
2 {
3     try
4     {
5         // Create an array to hold items read from the file.
6         const int SIZE = 5;
7         int[] numbers = new int[SIZE];
8
9         // Counter variable to use in the loop
10        int index = 0;

```

```

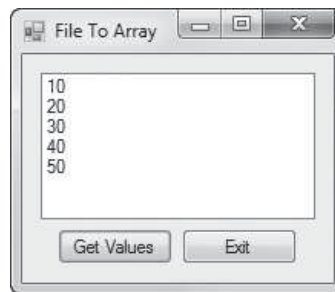
11
12     // Declare a StreamReader variable.
13     StreamReader inputFile;
14
15     // Open the file and get a StreamReader object.
16     inputFile = File.OpenText("Values.txt");
17
18     // Read the file's contents into the array.
19     while (index < numbers.Length && !inputFile.EndOfStream)
20     {
21         numbers[index] = int.Parse(inputFile.ReadLine());
22         index++;
23     }
24
25     // Close the file.
26     inputFile.Close();
27
28     // Display the array elements in the list box.
29     foreach (int value in numbers)
30     {
31         outputListBox.Items.Add(value);
32     }
33 }
34 catch (Exception ex)
35 {
36     // Display an error message.
37     MessageBox.Show(ex.Message);
38 }
39 }

```

The `try-catch` statement handles any file-related errors. Here is a summary of the code inside the `try` block:

- Lines 6 and 7 create an `int` array with five elements.
- Line 10 declares an `int` variable named `index`, initialized with the value 0. This variable will be used in a loop to hold subscript values.
- Line 13 declares a `StreamReader` variable named `inputFile`. (You do not see it in this code sample, but the directive using `System.IO`; appears at the top of the file. This is required for the `StreamReader` declaration in line 13.)
- Line 16 opens a file named `Values.txt` for reading. After this statement executes, the `inputFile` variable references a `StreamReader` object that is associated with the file.
- Line 19 is the beginning of a `while` loop that reads items from the file and assigns them to elements of the `numbers` array. Notice that the loop tests two Boolean expressions connected by the `&&` operator. The first expression is `index < numbers.Length`. The purpose of this expression is to prevent the loop from writing beyond the end of the array. When the array is full, the loop stops. The second expression is `!inputFile.EndOfStream`. The purpose of this expression is to prevent the loop from reading beyond the end of the file. When there are no more values to read from the file, the loop stops.
- Inside the loop, line 21 reads a line of text from the file, converts it to an `int`, and assigns the `int` to `numbers[index]`. Then, line 22 increments `index`.
- Line 26 closes the file.
- The `foreach` loop in lines 29–32 displays the array elements in the `outputListBox` control.

Figure 7-14 shows the application's form after the *Get Values* button has been clicked.

**Figure 7-14** The *File To Array* form

## 7.4 Passing Arrays as Arguments to Methods

**CONCEPT:** An array can be passed as an argument to a method. To pass an array, you pass the variable that references the array.

Sometimes you will want to write a method that accepts an entire array as an argument and performs an operation on the array. For example, the following code shows a method named `ShowArray`. The method accepts an array of strings as an argument and displays each element in a message box.

```
1 private void ShowArray(string[] strArray)
2 {
3     foreach (string str in strArray)
4     {
5         MessageBox.Show(str);
6     }
7 }
```

Notice in line 1 that the method has a parameter variable named `strArray` and that the parameter's data type is `string[]`. The expression `string[]` indicates that this parameter variable is a reference to a string array. When you call this method, you must pass a string array as an argument.

When you call a method and pass an array as an argument, you simply pass the variable that references the array. The following code shows an example of how the `ShowArray` method (previously shown) might be called:

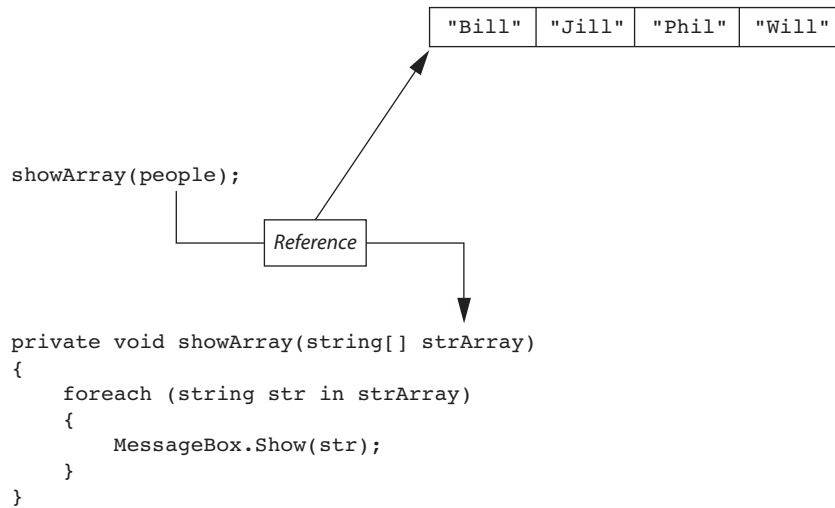
```
1 // Create an array of strings.
2 string[] people = { "Bill", "Jill", "Phil", "Will" };
3
4 // Pass the array to the ShowArray method.
5 ShowArray(people);
```

Line 2 creates an array of strings named `people` and initializes it with four strings. Line 5 calls the `ShowArray` method passing the `people` array as an argument.

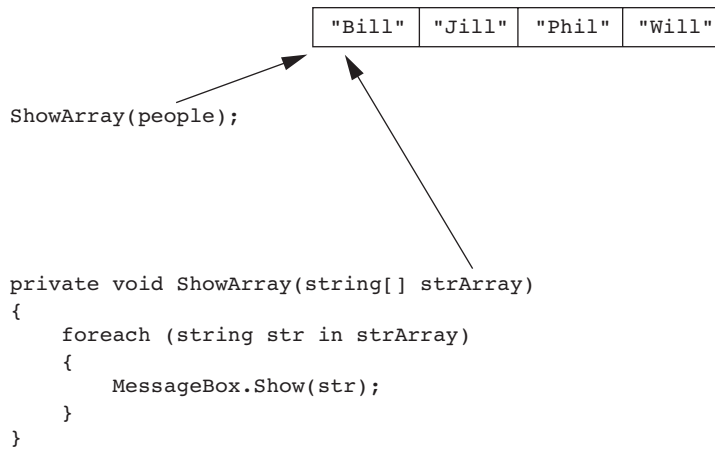
Keep in mind that arrays are *always* passed by reference. When you pass an array as an argument, the thing that is passed into the parameter variable is a reference to the array. This is illustrated in Figure 7-15. As shown in the figure, the `people` variable contains a reference to an array. When the `people` variable is passed to the `ShowArray` method, the reference to the array is passed into the `strArray` parameter variable. Figure 7-16 shows that while the `ShowArray` method is executing, the `people` variable and the `strArray` parameter variable reference the same array in memory.



**Figure 7-15** An array passed as an argument

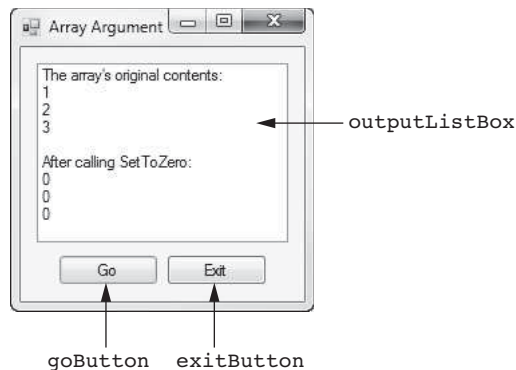


**Figure 7-16** The `people` and `strArray` variables referencing the same array



Because arrays are always passed by reference, a method that receives an array as an argument has access to the actual array (not a copy of the array). For example, in the *Chap07* folder of the Student Sample Programs, you will find a project named *Array Argument*. Figure 7-17 shows the application's form just after the user has clicked the

**Figure 7-17** The *Array Argument* application



Go button. The following code shows the Click event handler for the Go button, and a method named `SetToZero`:

```

1 // Click event handler for the goButton control.
2 private void goButton_Click(object sender, EventArgs e)
3 {
4     // Create an int array.
5     int[] numbers = { 1, 2, 3 };
6
7     // Display the array in the list box.
8     outputListBox.Items.Add("The array's original contents:");
9     foreach (int number in numbers)
10    {
11        outputListBox.Items.Add(number);
12    }
13
14    // Pass the array to the SetToZero method.
15    SetToZero(numbers);
16
17    // Display the array in the list box again.
18    outputListBox.Items.Add("");
19    outputListBox.Items.Add("After calling SetToZero:");
20    foreach (int number in numbers)
21    {
22        outputListBox.Items.Add(number);
23    }
24 }
25
26 // The SetToZero method accepts an int array as an
27 // argument and sets its elements to 0.
28 private void SetToZero(int[] iArray)
29 {
30     for (int index = 0; index < iArray.Length; index++)
31     {
32         iArray[index] = 0;
33     }
34 }

```

Let's take a closer look at the `goButton_Click` event handler:

- Line 5 creates an `int` array named `numbers`, initialized with the values 1, 2, and 3.
- Line 8 displays the string "The array's original contents:" in the `outputListBox` control.
- The `foreach` loop in lines 9–12 displays the contents of the `numbers` array in the `outputListBox` control. Look at Figure 7-17 and notice that the array's values are 1, 2, and 3.
- Line 15 calls the `SetToZero` method, passing the `numbers` array as an argument.
- Line 18 displays a blank line in the `outputListBox` control, and line 19 displays the string "After calling SetToZero:".
- The `foreach` loop in lines 20–23 displays the contents of the `numbers` array in the `outputListBox` control. Look at Figure 7-17 and notice that the array's values are now 0, 0, and 0.

As you can see from Figure 7-17, the `SetToZero` method changed the values stored in the `numbers` array. Let's look at the `SetToZero` method:

- Notice in line 28 that the method accepts an `int` array as an argument. The parameter variable's name is `iArray`.

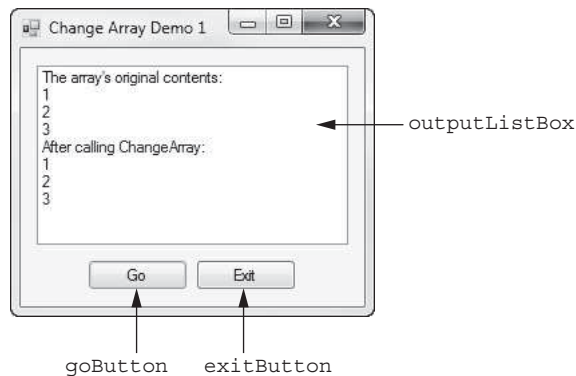
- Line 30 is the beginning of a `for` loop that steps through the array. As the loop iterates, the `index` variable is assigned the values 0, 1, 2, and so forth. The loop iterates as long as `index` is less than `iArray.Length`.
- The statement in line 32 assigns 0 to the array element `iArray[index]`.

Because the `iArray` parameter is a reference to the array that was passed as an argument, the statement in line 32 assigns 0 to an element of the `numbers` array.

## Using `ref` and `out` with Array Parameters

You saw in the previous example that arrays are always passed by reference. When you pass an array as an argument to a method, the method has direct access to the array through its parameter variable. However, the method cannot access the original reference variable that was used to pass the array. For example, in the *Chap07* folder of the Student Sample Programs, you will find a project named *Change Array 1*. Figure 7-18 shows the application's form just after the user has clicked the `Go` button. The following code shows the `Click` event handler for the `Go` button and a method named `ChangeArray`:

**Figure 7-18** The *Change Array 1* application



```

1 private void goButton_Click(object sender, EventArgs e)
2 {
3     // Create an int array.
4     int[] numbers = { 1, 2, 3 };
5
6     // Display the numbers array's contents.
7     outputListBox.Items.Add("The array's original contents:");
8     foreach (int value in numbers)
9     {
10        outputListBox.Items.Add(value);
11    }
12
13    // Pass the numbers array to the ChangeArray method.
14    ChangeArray(numbers);
15
16    // Display the numbers array's contents.
17    outputListBox.Items.Add("After calling ChangeArray:");
18    foreach (int value in numbers)
19    {
20        outputListBox.Items.Add(value);
21    }
22 }
23

```

```

24 private void ChangeArray(int[] iArray)
25 {
26     const int NEW_SIZE = 5;
27
28     // Make iArray reference a different array.
29     iArray = new int[NEW_SIZE];
30
31     // Set the new array's elements to 99.
32     for (int index = 0; index < iArray.Length; index++)
33     {
34         iArray[index] = 99;
35     }
36 }

```

Let's take a closer look at the `goButton_Click` event handler:

- Line 4 creates an `int` array named `numbers`, initialized with the values 1, 2, and 3.
- Lines 7–11 display the array's contents in the `outputListBox` control. Look at Figure 7-18 and notice that the array's values are 1, 2, and 3.
- Line 14 calls the `ChangeArray` method, passing the `numbers` array as an argument.
- Lines 17–21 display the contents of the `numbers` array in the `outputListBox` control after the `ChangeArray` method has executed. Look at Figure 7-18 and notice that the array's values are still 1, 2, and 3. Apparently the method did not change the array.

Let's look at the `ChangeArray` method:

- Notice in line 24 that the method accepts an `int` array as an argument. The parameter variable's name is `iArray`. Keep in mind that when we call this method in line 14, passing `numbers` as an argument, the `iArray` parameter and the `numbers` variable reference the same array in memory.
- Line 26 declares an `int` constant named `NEW_SIZE`, set to the value 5.
- Line 29 creates a new `int` array in memory with five elements. A reference to the array is assigned to the `iArray` parameter variable. As shown in Figure 7-19,

**Figure 7-19** After line 29 executes

```

private void goButton_Click(object sender, EventArgs e)
{
    // Create an int array.
    int[] numbers = { 1, 2, 3 };
    and so forth...

    ChangeArray(numbers);

    and so forth...
}

private void ChangeArray(int[] iArray)
{
    const int NEW_SIZE = 5;

    // Make iArray reference a different array.
    iArray = new int[NEW_SIZE];

    // Set the new array's elements to 99.
    for (int index = 0; index < iArray.Length; index++)
    {
        iArray[index] = 99;
    }
}

```

this causes the `iArray` parameter variable to no longer reference the array that was passed as an argument. Instead, the `iArray` parameter references the new array.

- The `for` loop in lines 32–35 assigns the value 99 to each element of array referenced by `iArray`. This does not affect the `numbers` array.

When you use either the `ref` or `out` keywords with an array parameter, the receiving method not only has access to the array, but it also has access to the reference variable that was used to pass the array. For example, the *Change Array 2* project, in the *Chap07* folder of the Student Sample Programs, is identical to the *Change Array 1* project, except that the `iArray` parameter is declared with the `ref` keyword in the `ChangeArray` method. The following code shows the Click event handler for the *Go* button, and the `ChangeArray` method.

```

1 private void goButton_Click(object sender, EventArgs e)
2 {
3     // Create an int array.
4     int[] numbers = { 1, 2, 3 };
5
6     // Display the number array's contents.
7     outputListBox.Items.Add("The array's original contents:");
8     foreach (int value in numbers)
9     {
10        outputListBox.Items.Add(value);
11    }
12
13    // Pass the number array to the ChangeArray method.
14    ChangeArray(ref numbers);
15
16    // Display the number array's contents.
17    outputListBox.Items.Add("After calling ChangeArray:");
18    foreach (int value in numbers)
19    {
20        outputListBox.Items.Add(value);
21    }
22 }
23
24 private void ChangeArray(ref int[] iArray)
25 {
26     const int NEW_SIZE = 5;
27
28     // Make iArray reference a different array.
29     iArray = new int[NEW_SIZE];
30
31     // Set the new array's elements to 99.
32     for (int index = 0; index < iArray.Length; index++)
33     {
34         iArray[index] = 99;
35     }
36 }

```

Notice that in line 24 the `iArray` parameter is declared with the `ref` keyword, and in line 14 the `ref` keyword is used to pass `numbers` as an argument to the `ChangeArray` method. In this code, the `iArray` parameter refers to the `numbers` variable. Anything that is done to the `iArray` parameter is actually done to the `numbers` variable. Figure 7-20 shows how line 29 causes the `numbers` variable to reference the new five-element array.

**Figure 7-20** After line 29 executes in the *Change Array 2* application

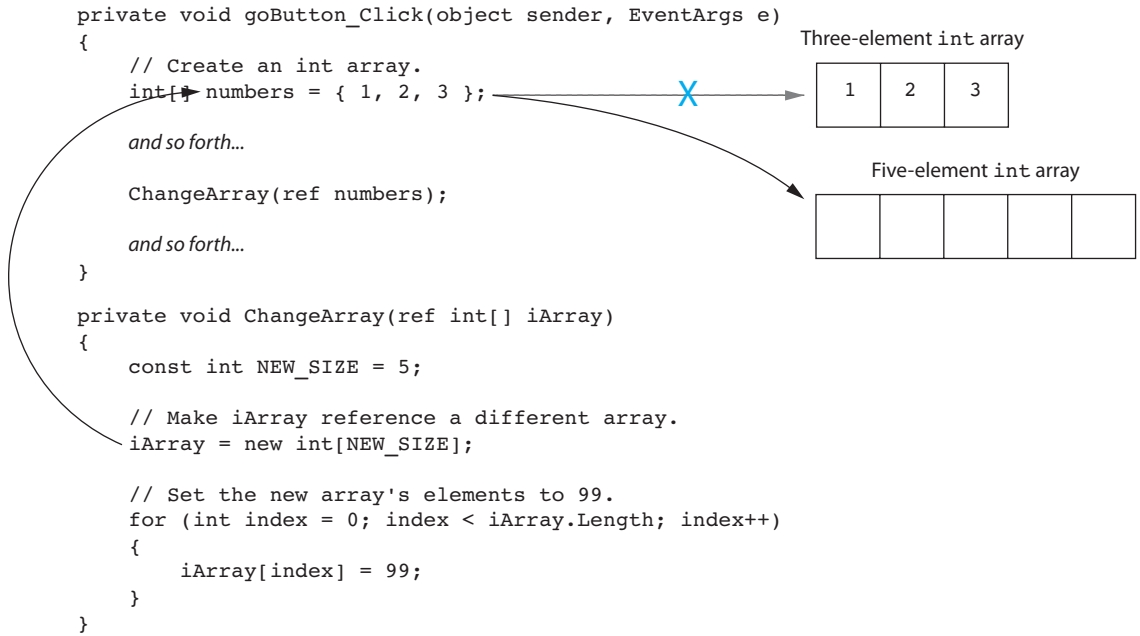
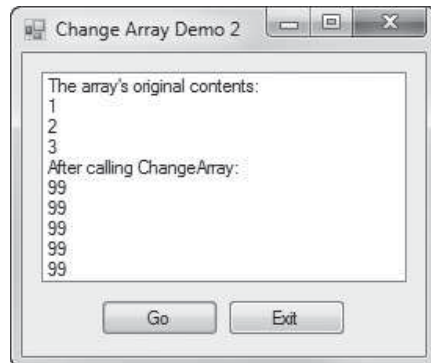


Figure 7-21 shows the application’s form just after the user has clicked the *Go* button. Notice from the program’s output that after the *ChangeArray* method has been called, the *numbers* variable references a five-element array, and each element’s value is 99.

**Figure 7-21** The *Change Array 1* application



 **Checkpoint**

- 7.11 When you pass an array as an argument, what is passed into the parameter variable?
- 7.12 Does a method that receives an array as an argument have access to the actual array or only a copy of the array?
- 7.13 What is the result when you use either the *ref* or *out* keyword with an array parameter?

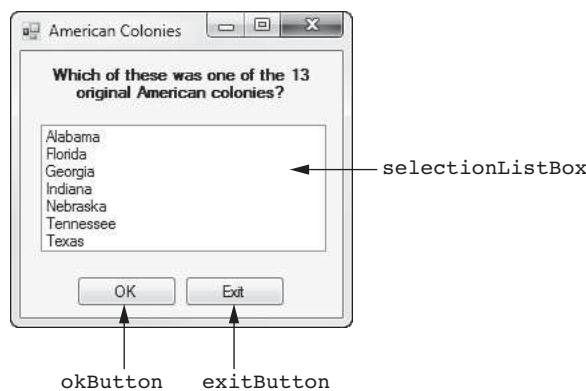
## 7.5 Some Useful Array Algorithms

### The Sequential Search

Programs commonly need to search for data that is stored in an array. Various techniques known as **search algorithms** have been developed to locate a specific item in a larger collection of data, such as an array. In this section we discuss the simplest of all search algorithms—the sequential search. The **sequential search algorithm** uses a loop to sequentially step through an array, starting with the first element. It compares each element with the value being searched for and stops when the value is found or the end of the array is encountered. If the value being searched for is not in the array, the algorithm unsuccessfully searches to the end of the array.

Let's look at an example. In the *Chap07* folder of the Student Sample Programs, you will find a project named *American Colonies*. The application is a game that tests your knowledge of U.S. history. As shown in Figure 7-22, the application's form displays a list of states in a ListBox control. Only one of the states shown in the ListBox was an original American colony. You select the state that you believe was a colony and click the *OK* button to see if you were correct.

**Figure 7-22** The *American Colonies* application



The following code is taken from the application. It shows a method named `SequentialSearch` and the Click event handler for the *OK* button.

```

1 // The SequentialSearch method searches a string array
2 // for a specified value. If the value is found, its
3 // position is returned. Otherwise, -1 is returned.
4 private int SequentialSearch(string[] sArray, string value)
5 {
6     bool found = false; // Flag indicating search results
7     int index = 0;      // Used to step through the array
8     int position = -1;  // Position of value, if found
9
10    // Search the array.
11    while (!found && index < sArray.Length)
12    {
13        if (sArray[index] == value)
14        {
15            found = true;
16            position = index;
17        }
18    }

```

```

19         index++;
20     }
21
22     // Return
23     return position;
24 }
25
26 private void okButton_Click(object sender, EventArgs e)
27 {
28     string selection;    // To hold the user's selection
29
30     // Create an array with the colony names.
31     string[] colonies = { "Delaware", "Pennsylvania", "New Jersey",
32                          "Georgia", "Connecticut", "Massachusetts",
33                          "Maryland", "South Carolina", "New Hampshire",
34                          "Virginia", "New York", "North Carolina",
35                          "Rhode Island" };
36
37     if (selectionListBox.SelectedIndex != -1)
38     {
39         // Get the selected item.
40         selection = selectionListBox.SelectedItem.ToString();
41
42         // Determine if the item is in the array.
43         if (SequentialSearch(colonies, selection) != -1)
44         {
45             MessageBox.Show("Yes, that was one of the colonies.");
46         }
47         else
48         {
49             MessageBox.Show("No, that was not one of the colonies.");
50         }
51     }
52 }

```

The `SequentialSearch` method, which begins in line 4, searches a `string` array for a specified value. It accepts a `string` array and a `string` search value as arguments. If the search value is found in the array, the method returns the value's subscript. If the search value is not found in the array, the method returns `-1`. Let's take a closer look at the method:

- Line 6 declares a `bool` variable named `found`. The `found` variable is used as a flag. Setting `found` to `false` indicates that the search value has not been found. Setting `found` to `true` indicates that the search value has been found. Notice that `found` is initialized with `false`.
- Line 7 declares an `int` variable named `index` that will be used to step through the elements of the array. Notice that `index` is initialized with the value 0.
- Line 8 declares an `int` variable named `position`. If the search value is found in the array, we save its subscript in the `position` variable. Notice that the `position` variable is initialized with the value `-1`.
- The `while` loop that begins in line 11 searches the array for the specified value. It iterates as long as `found` is not `true` and `index` is less than the array's length.
- The `if` statement in line 13 determines whether `sArray[index]` is equal to `value`. If this is true, then the search value has been found in the array. In that case, line 15 sets `found` to `true`, and line 16 assigns `index` to `position`.
- Line 19 increments `index`.
- When the loop finishes, line 23 returns the value of the `position` variable. If the search value was found in the array, the `position` variable will contain the value's subscript. If the search value was not found in the array, the `position` variable will still be set to `-1`.



The Click event handler for the OK button begins in line 26. Let's take a closer look at the event handler's code:

- Line 28 declares a `string` variable named `selection`. This variable will hold the item that is selected from the `ListBox` control.
- Lines 31–35 declare a `string` array named `colonies`. The array is initialized with the names of the U.S. colonies.
- The `if` statement that begins in line 37 determines whether an item has been selected in the `selectionListBox` control. If an item has been selected, the following actions take place:
  - Line 40 gets the selected item and assigns it to the `selection` variable.
  - The `if` statement in line 43 calls the `SequentialSearch` method, passing the `colonies` array and the `selection` variable as arguments. If the value of the `selection` variable is found in the `colonies` array, the method returns a value other than `-1`, and line 45 displays a message box informing the user that the selected item was one of the colonies. However, if the value of the `selection` variable is not found in the `colonies` array, the method will return `-1`, and line 49 displays a message box informing the user that the selected item was not one of the colonies.

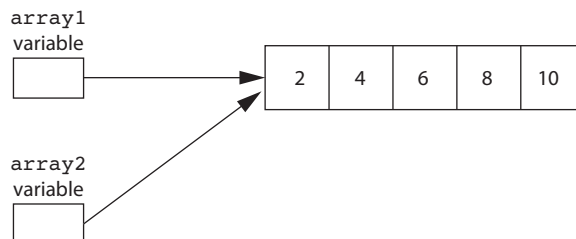
## Copying an Array

Because an array is an object, there is a distinction between an array and the variable that references it. The array and the reference variable are two separate entities. This is important to remember when you wish to copy the contents of one array to another. You might be tempted to write something like the following code, thinking that you are copying an array:

```
int[] array1 = { 2, 4, 6, 8, 10 };
int[] array2 = array1; // This does not copy array1.
```

The first statement creates an array referenced by the `array1` variable. The second statement assigns `array1` to `array2`. This does not make a copy of the array referenced by `array1`. Rather, it assigns the reference that is in `array1` to `array2`. After this statement executes, both the `array1` and `array2` variables will reference the same array. This type of assignment operation is called a **reference copy**. Only a reference to the array object is copied, not the contents of the array object. This is illustrated in Figure 7-23.

**Figure 7-23** Both `array1` and `array2` referencing the same array



If you want to make a copy of an array, you must create the second array in memory and then copy the individual elements of the first array to the second. This is usually best done with a loop, such as the following:

```
1 const int SIZE = 5;
2 int[] firstArray = { 5, 10, 15, 20, 25 };
3 int[] secondArray = new int[SIZE];
4
```

```

5 for (int index = 0; index < firstArray.length; index++)
6 {
7     secondArray[index] = firstArray[index];
8 }

```

The loop in this code copies each element of `firstArray` to the corresponding element of `secondArray`.

## Comparing Arrays

You cannot use the `==` operator to compare two array reference variables and determine whether the arrays are equal. For example, the following code appears to compare two arrays, but in reality it does not:

```

1 int[] firstArray = { 5, 10, 15, 20, 25 };
2 int[] secondArray = { 5, 10, 15, 20, 25 };
3
4 if (firstArray == secondArray) // This is a mistake.
5 {
6     MessageBox.Show("The arrays are the same.");
7 }
8 else
9 {
10    MessageBox.Show("The arrays are not the same.");
11 }

```

When you use the `==` operator with reference variables, the operator compares the references that the variables contain, not the contents of the objects referenced by the variables. Because the `firstArray` and `secondArray` variables in this example reference different objects in memory, the result of the Boolean expression `firstArray == secondArray` is false, and the code reports that the arrays are not the same.

To compare the contents of two arrays, you must compare the elements of the two arrays. For example, look at the following code:

```

1 int[] firstArray = { 2, 4, 6, 8, 10 };
2 int[] secondArray = { 2, 4, 6, 8, 10 };
3 boolean arraysEqual = true; // Flag variable
4 int index = 0; // To hold array subscripts
5
6 // First determine whether the arrays are the same size.
7 if (firstArray.length != secondArray.length)
8 {
9     arraysEqual = false;
10 }
11
12 // Next determine whether the elements contain the same data.
13 while (arraysEqual && index < firstArray.length)
14 {
15     if (firstArray[index] != secondArray[index])
16     {
17         arraysEqual = false;
18     }
19     index++;
20 }
21
22 if (arraysEqual)
23 {
24     MessageBox.Show("The arrays are equal.");
25 }
26 else

```

```

27 {
28     MessageBox.Show("The arrays are not equal.");
29 }

```

This code determines whether `firstArray` and `secondArray` (declared in lines 1 and 2) contain the same values. A Boolean flag variable, `arraysEqual`, is declared and initialized to `true` in line 3. The `arraysEqual` variable is used to signal whether the arrays are equal. Another variable, `index`, is declared and initialized to 0 in line 4. The `index` variable is used in a loop to step through the arrays.

First, the `if` statement in line 7 determines whether the two arrays are the same length. If they are not the same length, then the arrays cannot be equal, so the flag variable `arraysEqual` is set to `false` in line 9. Then a `while` loop begins in line 13. The loop executes as long as `arraysEqual` is true and the `index` variable is less than `firstArray.length`. During each iteration, it compares a different set of corresponding elements in the arrays. When it finds two corresponding elements that have different values, the flag variable `arraysEqual` is set to `false`.

After the loop finishes, an `if` statement examines the `arraysEqual` variable in line 22. If the variable is `true`, then the arrays are equal and a message indicating so is displayed in line 24. Otherwise, they are not equal, so a different message is displayed in line 28.

## Totaling the Values in an Array

To calculate the total of the values in a numeric array, you use a loop with an accumulator variable. First, the accumulator is initialized with 0. Then, the loop steps through the array, adding the value of each array element to the accumulator.

```

1 // Create an int array.
2 int[] numbers = { 2, 4, 6, 8, 10 };
3
4 // Declare and initialize an accumulator variable.
5 int total = 0;
6
7 // Step through the array, adding each element to
8 // the accumulator.
9 for (int index = 0; index < numbers.Length; index++)
10 {
11     total += numbers[index];
12 }
13
14 // Display the total.
15 MessageBox.Show("The total is " + total);

```

## Averaging the Values in an Array

The first step in calculating the average of all the values in a numeric array is to get the total of the values. The second step is to divide the total by the number of elements in the array. The following code shows an example:

```

1 // Create an array.
2 double[] scores = { 92.5, 81.6, 65.7, 72.8 }
3
4 // Declare and initialize an accumulator variable.
5 double total = 0.0;
6
7 // Declare a variable to hold the average.

```

```

8 double average;
9
10 // Step through the array, adding each element to
11 // the accumulator.
12 for (int index = 0; index < scores.Length; index++)
13 {
14     total += scores[index];
15 }
16
17 // Calculate the average.
18 average = total / scores.Length;
19
20 // Display the average.
21 MessageBox.Show("The average is " + average);

```

When this code finishes, the `average` variable will contain the average of the values in the `scores` array. Notice that the last statement, which divides `total` by `scores.Length`, is not inside the loop. This statement should execute only once, after the loop has finished its iterations.

## Finding the Highest and Lowest Values in an Array

Some programming tasks require you to find the highest value in a set of data. Examples include programs that report the highest sales amount for a given time period, the highest test score in a set of test scores, the highest temperature for a given set of days, and so forth.

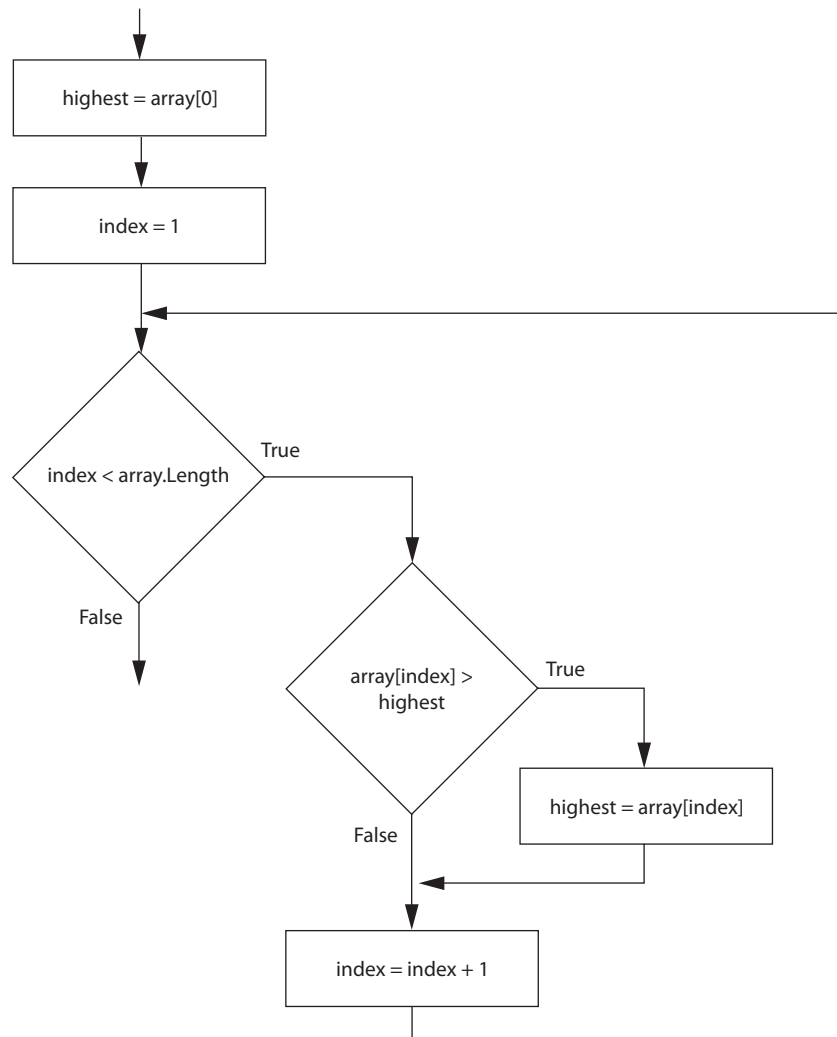
The algorithm for finding the highest value in an array works like this: You create a variable to hold the highest value (the following example names this variable `highest`). Then, you assign the value at element 0 to the `highest` variable. Next, you use a loop to step through the rest of the array elements, beginning at element 1. Each time the loop iterates, it compares an array element to the `highest` variable. If the array element is greater than the `highest` variable, then the value in the array element is assigned to the `highest` variable. When the loop finishes, the `highest` variable will contain the highest value in the array. The flowchart in Figure 7-24 illustrates this logic.

The following code demonstrates this algorithm:

```

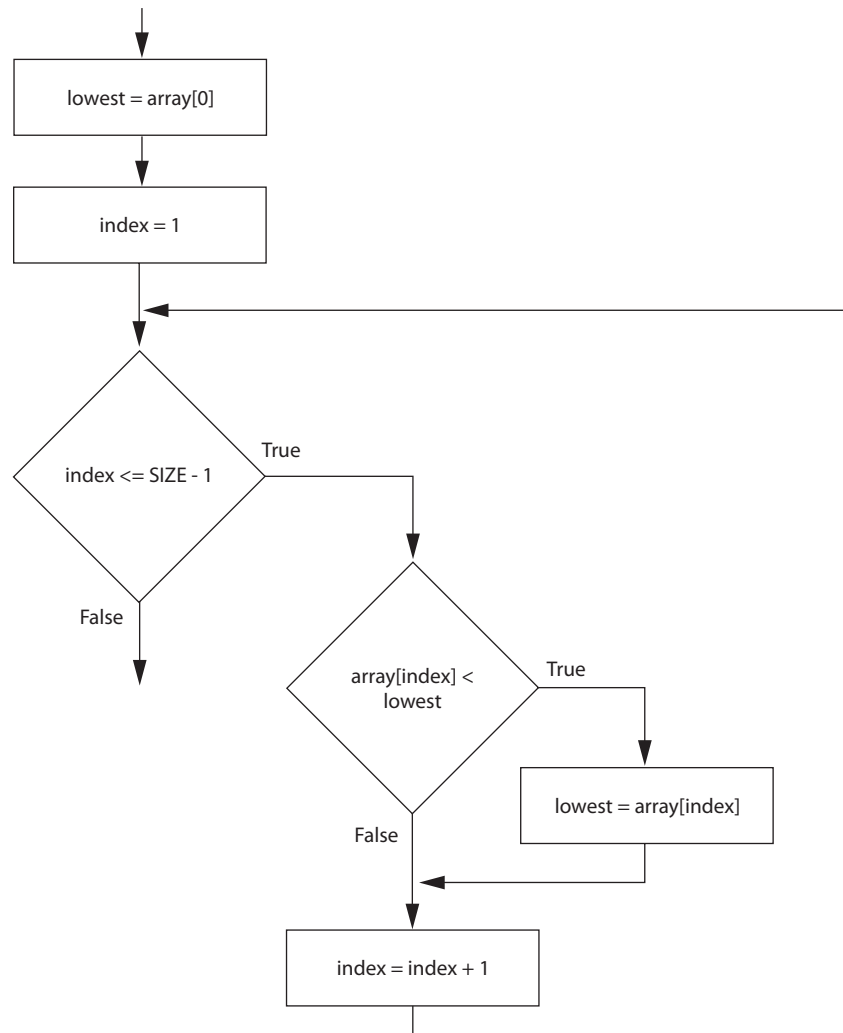
1 // Create an array.
2 int[] numbers = { 8, 1, 12, 6, 2 };
3
4 // Declare a variable to hold the highest value, and
5 // initialize it with the first value in the array.
6 int highest = numbers[0];
7
8 // Step through the rest of the array, beginning at
9 // element 1. When a value greater than highest is found,
10 // assign that value to highest.
11 for (int index = 1; index < numbers.Length; index++)
12 {
13     if (numbers[index] > highest)
14     {
15         highest = numbers[index];
16     }
17 }
18
19 // Display the highest value.
20 MessageBox.Show("The highest value is " + highest);

```

**Figure 7-24** Flowchart for finding the highest value in an array

In some programs you are more interested in finding the lowest value than the highest value in a set of data. For example, suppose you are writing a program that stores several players' golf scores in an array and you need to find the best score. In golf, the lower the score the better, so you need an algorithm that finds the lowest value in the array.

The algorithm for finding the lowest value in an array is very similar to the algorithm for finding the highest score. It works like this: You create a variable to hold the lowest value (the following example names this variable `lowest`). Then, you assign the value at element 0 to the `lowest` variable. Next, you use a loop to step through the rest of the array elements, beginning at element 1. Each time the loop iterates, it compares an array element to the `lowest` variable. If the array element is less than the `lowest` variable, then the value in the array element is assigned to the `lowest` variable. When the loop finishes, the `lowest` variable contains the lowest value in the array. The flowchart in Figure 7-25 illustrates this logic.

**Figure 7-25** Flowchart for finding the lowest value in an array

The following code demonstrates this algorithm:

```

1 // Create an array.
2 int[] numbers = { 8, 1, 12, 6, 2 };
3
4 // Declare a variable to hold the lowest value, and
5 // initialize it with the first value in the array.
6 int lowest = numbers[0];
7
8 // Step through the rest of the array, beginning at
9 // element 1. When a value less than lowest is found,
10 // assign that value to lowest.
11 for (int index = 1; index < numbers.Length; index++)
12 {
13     if (numbers[index] < lowest)
14     {
15         lowest = numbers[index];
16     }
17 }
18
19 // Display the lowest value.
20 MessageBox.Show("The lowest value is " + lowest);

```

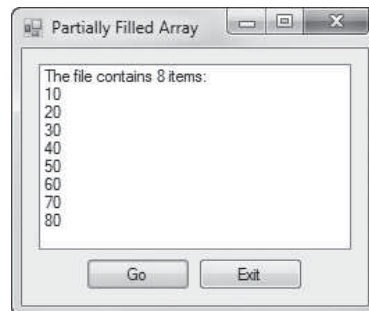
## Partially Filled Arrays

Sometimes you need to store a series of items in an array, but you do not know the number of items in the series. As a result, you do not know the exact number of elements needed for the array. One solution is to make the array large enough to hold the largest possible number of items. This can lead to another problem, however. If the actual number of items stored in the array is less than the number of elements, the array will be only partially filled. When you process a partially filled array, you must process only the elements that contain valid data items.

A partially filled array is normally used with an accompanying integer variable that holds the number of items that are actually stored in the array. If the array is empty, then 0 is stored in this variable because there are no items in the array. Each time an item is added to the array, the variable is incremented. When code steps through the array's elements, the value of this variable is used instead of the array's size to determine the maximum subscript.

For example, in the *Chap07* folder of the Student Sample Programs, you will find a project named *Partially Filled Array*. When you click the *Go* button, the application reads up to 100 values from a file named *Values.txt* and stores them in a 100-element `int` array. If the file contains fewer than 100 values, the application will partially fill the array. The contents of the array are then displayed in a list box. Figure 7-26 shows the application's form just after the user has clicked the *Go* button. The following code shows the *Click* event handler for the *Get Values* button.

**Figure 7-26** The *Partially Filled Array* application



```

1 private void goButton_Click(object sender, EventArgs e)
2 {
3     try
4     {
5         // Create an array to hold items read from the file.
6         const int SIZE = 100;
7         int[] numbers = new int[SIZE];
8
9         // Variable to hold the number of items stored in
10        // the array
11        int count = 0;
12
13        // Declare a StreamReader variable.
14        StreamReader inputFile;
15
16        // Open the file and get a StreamReader object.
17        inputFile = File.OpenText("Values.txt");
18

```

```

19         // Read the file's contents into the array until the
20         // end of the file is reached, or the array is full.
21         while (!inputFile.EndOfStream && count < numbers.Length)
22         {
23             // Read the next item from the file.
24             numbers[count] = int.Parse(inputFile.ReadLine());
25
26             // Increment count.
27             count++;
28         }
29
30         // Close the file.
31         inputFile.Close();
32
33         // Display the array elements in the list box.
34         outputListBox.Items.Add("The file contains " + count +
35             " items:");
36
37         for (int index = 0; index < count; index++)
38         {
39             outputListBox.Items.Add(numbers[index]);
40         }
41     }
42     catch (Exception ex)
43     {
44         // Display an error message.
45         MessageBox.Show(ex.Message);
46     }
47 }

```

Let's examine the code in detail:

- Line 3 is the beginning of a try-catch statement that handles any errors that might result while reading data from the file.
- Line 6 declares a constant, `SIZE`, initialized with the value 100.
- Line 7 declares an `int` array named `numbers` using `SIZE` as the size declarator. As a result, the values array has 100 elements.
- Line 11 declares an `int` variable named `count`, which holds the number of items that are stored in the `numbers` array. Notice that `count` is initialized with 0 because there are no values stored in the array.
- Line 14 declares a `StreamReader` variable named `inputFile`. (You do not see it in this code sample, but the directive using `System.IO`; appears at the top of the file. This is required for the `StreamReader` declaration in line 14.)
- Line 17 opens a file named `Values.txt` for reading. After this statement executes, the `inputFile` variable references a `StreamReader` object that is associated with the file.
- Line 21 is the beginning of a `while` loop that reads items from the file and assigns them to elements of the `numbers` array. Notice that the loop tests two Boolean expressions connected by the `&&` operator. The first expression is `!inputFile.EndOfStream`. The purpose of this expression is to prevent the loop from reading beyond the end of the file. When there are no more values to read from the file, the loop stops. The second expression is `count < numbers.Length`. The purpose of this expression is to prevent the loop from writing beyond the end of the array. When the array is full, the loop will stop.
- Inside the loop, line 24 reads a line of text from the file, converts it to an `int`, and assigns the `int` to `numbers[index]`.
- Then, line 27 increments the `count` variable. Each time a number is assigned to an array element, the `count` variable is incremented. As a result, the `count` variable holds the number of items that are stored in the array.



- Line 31 closes the file.
- The `for` loop in lines 37–40 displays the array elements in the `outputListBox` control. Rather than stepping through all the elements in the array, however, the loop steps through only the elements that contain values. Notice that the loop iterates as long as `index` is less than `count`. Because `count` contains the number of items stored in the array, the loop stops when the element containing the last valid value has been displayed.

Now that you've seen several algorithms for processing the contents of an array, you should practice writing some of them yourself. Tutorial 7-2 takes you through the process of writing an application that reads data from a file into an `int` array and then determines the highest, lowest, and average values in the array.



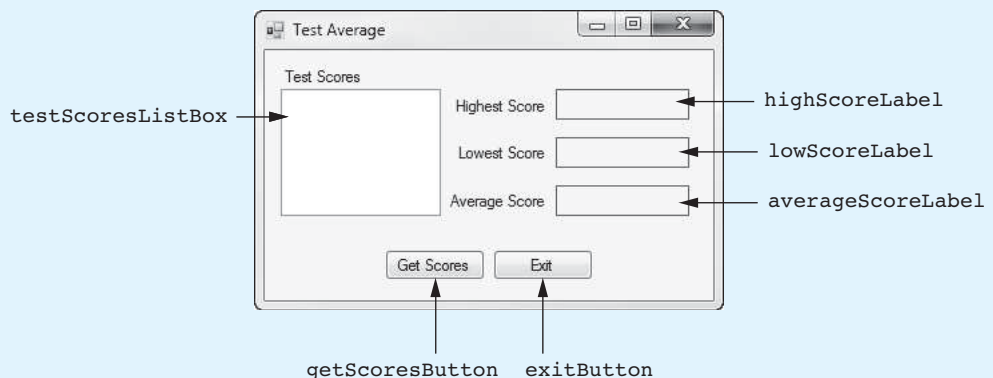
VideoNote

**Tutorial 7-2:**  
Processing an  
Array

## Tutorial 7-2: Processing an Array

In this tutorial you complete an application that reads five test scores from a file and stores the test scores in an array. The application displays the test scores as well as the highest score, the lowest score, and the average score. Figure 7-27 shows the application's form, which has already been created for you. A set of five test scores is stored in a file named `TestScores.txt`, which has also been created for you.

**Figure 7-27** The *Test Average* application's form



**Step 1:** Start Visual Studio (or Visual Studio Express). Open the project named *Test Average* in the *Chap07* folder of the Student Sample Programs.

**Step 2:** Open the `Form1` form's code in the code editor. Insert the `using System.IO;` directive shown in line 10 of Program 7-2 at the end of this tutorial. This statement is necessary because we will be using the `StreamReader` class, and it is part of the `System.IO` namespace in the .NET Framework.

**Step 3:** With the code editor still open, type the comments and code for the `Average` method, shown in lines 21–40 of Program 7-2. The purpose of the `Average` method is to accept an `int` array as an argument and return the average of the values in the array. This method uses an algorithm similar to the array averaging you saw earlier in this chapter.

**Step 4:** Type the comments and code for the `Highest` method, shown in lines 42–63 of Program 7-2. The purpose of the `Highest` method is to accept an `int`

array as an argument and return the highest value in the array. This method uses an algorithm similar to the algorithm that you saw earlier in this chapter for finding the highest value in an array.

**Step 5:** Type the comments and code for the `Lowest` method, shown in lines 65–86 of Program 7-2. The purpose of the `Lowest` method is to accept an `int` array as an argument and return the lowest value in the array. This method uses an algorithm similar to the algorithm that you saw earlier in this chapter for finding the lowest value in an array.

**Step 6:** Now you create the Click event handlers for the Button controls. Switch back to the *Designer* and double-click the `getScoresButton` control. This opens the code editor, and you will see an empty event handler named `getScoresButton_Click`. Complete the `getScoresButton_Click` event handler by typing the code shown in lines 90–134 in Program 7-2. Let's review this code:

**Line 90:** This is the beginning of a `try-catch` statement that handles any exceptions that are thrown while reading and processing data from the file. If an exception occurs in the `try` block (lines 92–128), the program jumps to the `catch` block, and line 133 displays an error message.

**Lines 93–99:** The following declarations appear in these lines:

- `SIZE`—a constant, set to 5, for the number of test scores
- `scores`—an `int` array that holds the test scores
- `index`—an `int` variable, initialized to 0, that is used in a loop to step through the elements of the `scores` array
- `highestScore`—an `int` that holds the highest score
- `lowestScore`—an `int` that holds the lowest score
- `averageScore`—a `double` that holds the average score
- `inputFile`—a variable that references the `StreamReader` object that is used to read data from the file

**Line 102:** After this statement executes, the `TestScores.txt` file will be opened for reading, and the `inputFile` variable will reference a `StreamReader` object that is associated with the file.

**Line 105:** This is the beginning of a `while` loop that iterates as long as the end of the `TestScores.txt` file has not been reached and as long as `index` is less than `scores.Length`. (Recall that `index` starts with the value 0.)

**Line 107:** This statement reads a line of text from the file and assigns it to the array element `scores[index]`.

**Line 108:** This statement increments the `index` variable.

**Line 112:** This statement closes the `TestScores.txt` file.

**Lines 115–118:** This `foreach` loop displays the contents of the `scores` array in the `testScoresListBox` control.

**Line 121:** This statement calls the `Highest` method, passing the `scores` array as an argument. The method returns the highest value in the array, which is assigned to the `highestScore` variable.

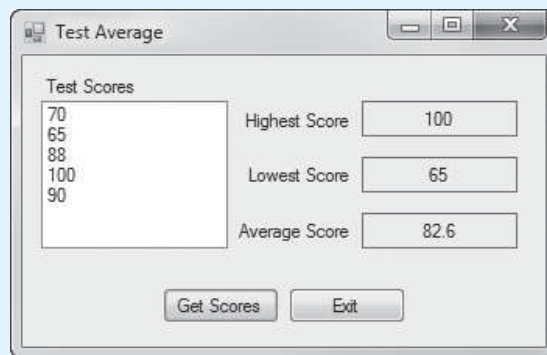
**Line 122:** This statement calls the `Lowest` method, passing the `scores` array as an argument. The method returns the lowest value in the array, which is assigned to the `lowestScore` variable.

**Line 123:** This statement calls the `Average` method, passing the `scores` array as an argument. The method returns the average of the values in the array, which is assigned to the `averageScore` variable.

**Lines 126–128:** These statements display the highest score, lowest score, and average score.

- Step 7:** Switch your view back to the *Designer* and double-click the `exitButton` control. In the code editor you will see an empty event handler named `exitButton_Click`. Complete the `exitButton_Click` event handler by typing the code shown in lines 139–140 in Program 7-2.
- Step 8:** Save the project. Then, press `[F5]` on the keyboard or click the *Start Debugging* button (🐞) on the toolbar to compile and run the application. When the application runs, click the *Get Scores* button. This should display a set of test scores in `ListBox` as well as the highest, lowest, and average of the test scores, as shown in Figure 7-28. Click the *Exit* button to exit the application.

**Figure 7-28** The *Test Average* application



**Program 7-2** Completed code for `Form1` in the *Test Average* application

```

1 using System;
2 using System.Collections.Generic;
3 using System.ComponentModel;
4 using System.Data;
5 using System.Drawing;
6 using System.Linq;
7 using System.Text;
8 using System.Threading.Tasks;
9 using System.Windows.Forms;
10 using System.IO;
11
12 namespace Test_Average
13 {
14     public partial class Form1 : Form
15     {
16         public Form1()
17         {
18             InitializeComponent();
19         }
20
21         // The Average method accepts an int array argument
22         // and returns the Average of the values in the array.
23         private double Average(int[] iArray)
24         {

```

```

25         int total = 0;    // Accumulator, initialized to 0
26         double average; // To hold the average
27
28         // Step through the array, adding each element to
29         // the accumulator.
30         for (int index = 0; index < iArray.Length; index++)
31         {
32             total += iArray[index];
33         }
34
35         // Calculate the average.
36         average = (double) total / iArray.Length;
37
38         // Return the average.
39         return average;
40     }
41
42     // The Highest method accepts an int array argument
43     // and returns the highest value in that array.
44     private int Highest(int[] iArray)
45     {
46         // Declare a variable to hold the highest value, and
47         // initialize it with the first value in the array.
48         int highest = iArray[0];
49
50         // Step through the rest of the array, beginning at
51         // element 1. When a value greater than highest is found,
52         // assign that value to highest.
53         for (int index = 1; index < iArray.Length; index++)
54         {
55             if (iArray[index] > highest)
56             {
57                 highest = iArray[index];
58             }
59         }
60
61         // Return the highest value.
62         return highest;
63     }
64
65     // The Lowest method accepts an int array argument
66     // and returns the lowest value in that array.
67     private int Lowest(int[] iArray)
68     {
69         // Declare a variable to hold the lowest value, and
70         // initialize it with the first value in the array.
71         int lowest = iArray[0];
72
73         // Step through the rest of the array, beginning at
74         // element 1. When a value less than lowest is found,
75         // assign that value to lowest.
76         for (int index = 1; index < iArray.Length; index++)
77         {
78             if (iArray[index] < lowest)
79             {
80                 lowest = iArray[index];
81             }
82         }
83
84         // Return the lowest value.

```

```

85         return lowest;
86     }
87
88     private void getScoresButton_Click(object sender, EventArgs e)
89     {
90         try
91         {
92             // Local variables
93             const int SIZE = 5;           // Number of tests
94             int[] scores = new int[SIZE]; // Array of test scores
95             int index = 0;                // Loop counter
96             int highestScore;            // To hold the highest score
97             int lowestScore;             // To hold the lowest score
98             double averageScore;        // To hold the average score
99             StreamReader inputFile;      // For file input
100
101             // Open the file and get a StreamReader object.
102             inputFile = File.OpenText("TestScores.txt");
103
104             // Read the test scores into the array.
105             while (!inputFile.EndOfStream && index < scores.Length)
106             {
107                 scores[index] = int.Parse(inputFile.ReadLine());
108                 index++;
109             }
110
111             // Close the file.
112             inputFile.Close();
113
114             // Display the test scores.
115             foreach (int value in scores)
116             {
117                 testScoresListBox.Items.Add(value);
118             }
119
120             // Get the highest, lowest, and average scores.
121             highestScore = Highest(scores);
122             lowestScore = Lowest(scores);
123             averageScore = Average(scores);
124
125             // Display the values.
126             highScoreLabel.Text = highestScore.ToString();
127             lowScoreLabel.Text = lowestScore.ToString();
128             averageScoreLabel.Text = averageScore.ToString("n1");
129         }
130         catch (Exception ex)
131         {
132             // Display an error message.
133             MessageBox.Show(ex.Message);
134         }
135     }
136
137     private void exitButton_Click(object sender, EventArgs e)
138     {
139         // Close the form.
140         this.Close();
141     }
142 }
143 }

```

## 7.6 Advanced Algorithms for Sorting and Searching Arrays

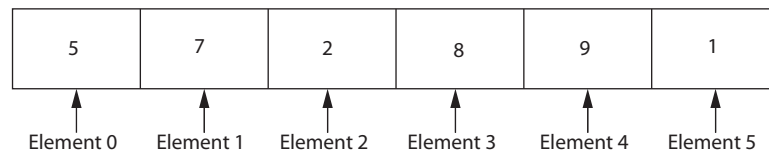
**CONCEPT:** A sorting algorithm is used to arrange data into some order. A search algorithm is a method of locating a specific item in a larger collection of data. The selection sort and the binary search are popular sorting and searching algorithms.

### The Selection Sort Algorithm

Often the data in an array must be sorted in some order. Customer lists, for instance, are commonly sorted in alphabetical order. Student grades might be sorted from highest to lowest. Product codes could be sorted so all the products of the same color are stored together. In this section we explore how to write your own sorting algorithm. A sorting algorithm is a technique for scanning through an array and rearranging its contents in some specific order. The algorithm that we explore is called the selection sort.

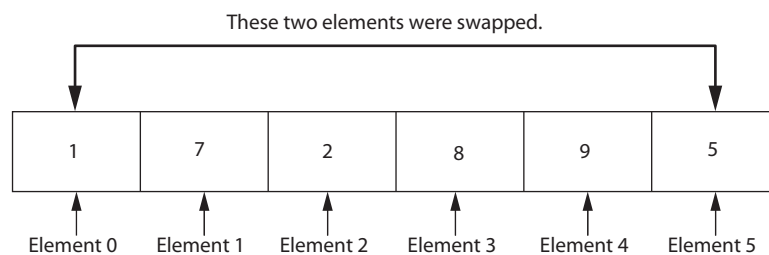
The **selection sort** works like this: The smallest value in the array is located and moved to element 0. Then the next smallest value is located and moved to element 1. This process continues until all the elements have been placed in their proper order. Let's see how the selection sort works when arranging the elements of the array in Figure 7-29.

**Figure 7-29** Values in an array



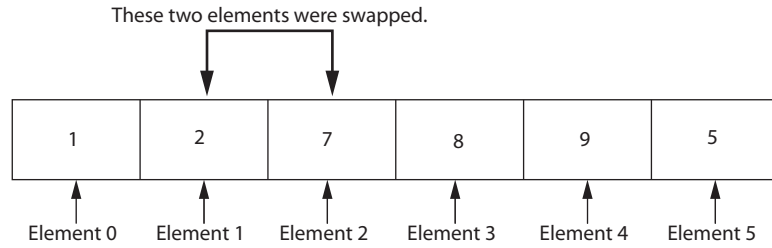
The selection sort scans the array, starting at element 0, and locates the element with the smallest value. Then, the contents of this element are swapped with the contents of element 0. In this example, the 1 stored in element 5 is swapped with the 5 stored in element 0. After the swap, the array appears as shown in Figure 7-30.

**Figure 7-30** Values in the array after the first swap



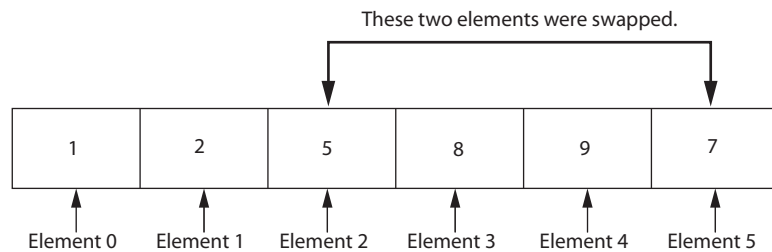
Then, the algorithm repeats the process, but because element 0 already contains the smallest value in the array, it can be left out of the procedure. This time, the algorithm begins the scan at element 1. In this example, the value in element 2 is swapped with the value in element 1. Then, the array appears as shown in Figure 7-31.

**Figure 7-31** Values in the array after the second swap



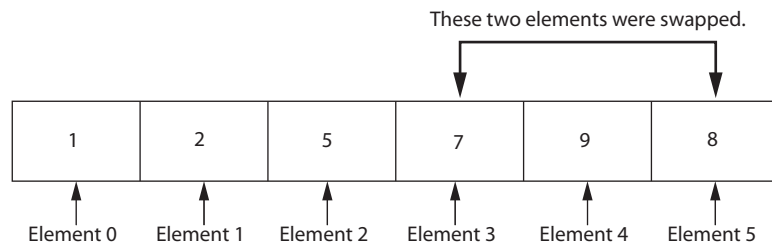
Once again, the process is repeated, but this time the scan begins at element 2. The algorithm will find that element 5 contains the next smallest value. This element's value is swapped with that of element 2, causing the array to appear as shown in Figure 7-32.

**Figure 7-32** Values in the array after the third swap



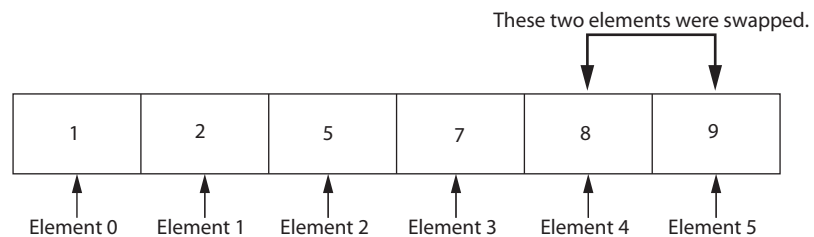
Next, the scanning begins at element 3. Its value is swapped with that of element 5, causing the array to appear as shown in Figure 7-33.

**Figure 7-33** Values in the array after the fourth swap



At this point there are only two elements left to sort. The algorithm finds that the value in element 5 is smaller than that of element 4, so the two are swapped. This puts the array in its final arrangement, as shown in Figure 7-34.

**Figure 7-34** Values in the array after the fifth swap



## Swapping Array Elements

As you saw in the description of the selection sort algorithm, certain elements are swapped as the algorithm steps through the array. Let's briefly discuss the process of swapping two items in computer memory. Assume we have the following variable declarations:

```
int a = 1;
int b = 9;
```

Suppose we want to swap the values in these variables so the variable `a` contains 9 and the variable `b` contains 1. At first, you might think that we need only assign the variables to each other, like this:

```
// ERROR! The following does NOT swap the variables.
a = b;
b = a;
```

To understand why this does not work, let's step through the code. The first statement is `a = b`. This causes the value 9 to be assigned to `a`. But, what happens to the value 1 that was previously stored in `a`? Remember, when you assign a new value to a variable, the new value replaces any value that was previously stored in the variable. So, the old value, 1, is thrown away. Then the next statement is `b = a`. Since the variable `a` contains 9, this assigns 9 to `b`. After these statements execute, the variables `a` and `b` both contain the value 9.

To successfully swap the contents of two variables, we need a third variable that can serve as a temporary storage location:

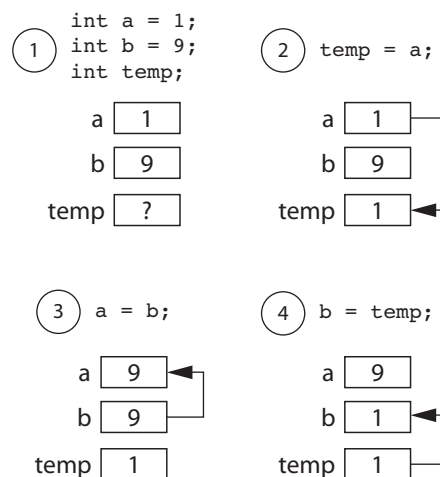
```
int temp;
```

Then we can perform the following steps to swap the values in the variables `a` and `b`:

- Assign the value of `a` to `temp`.
- Assign the value of `b` to `a`.
- Assign the value of `temp` to `b`.

Figure 7-35 shows the contents of these variables as we perform each of these steps. Notice that after the steps are finished, the values in `a` and `b` are swapped.

**Figure 7-35** Swapping the values of `a` and `b`





Here is the code for a Swap method that we can use to swap two `int` values:

```

1 private void Swap(ref int a, ref int b)
2 {
3     int temp = a;
4     a = b;
5     b = temp;
6 }

```



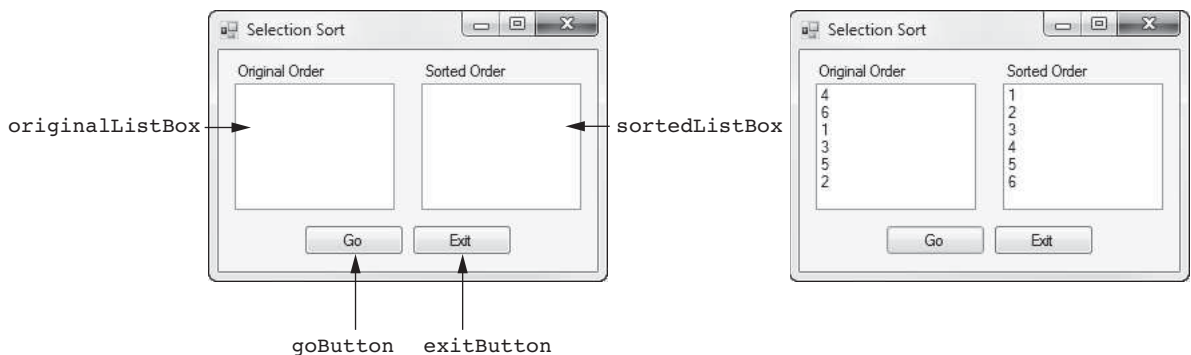
**NOTE:** It is critical that we use reference parameters in the `Swap` method, because the method must be able to change the values of the items that are passed to it as arguments.

Let's look at a complete program that demonstrates the Selection Sort algorithm. In the `Chap07` folder of the Student Sample Programs, you will find a project named *Selection Sort*. Figure 7-36 shows the application's form. On the left, you see the form with the names of various controls. On the right you see the form after the `Go` button has been clicked. When you click the `Go` button, the following actions take place:

- An `int` array is created, initialized with unsorted values.
- The contents of the array are displayed in the `originalListBox` control.
- The array is passed as an argument to the `SelectionSort` method. The method uses the Selection Sort algorithm to sort the array.
- The contents of the array are displayed in the `sortedListBox` control.

Program 7-3 shows the complete code for the *Selection Sort* application.

**Figure 7-36** The *Selection Sort* application's form



**Program 7-3** Complete code for `Form1` in the *Selection Sort* application

```

1 using System;
2 using System.Collections.Generic;
3 using System.ComponentModel;
4 using System.Data;
5 using System.Drawing;
6 using System.Linq;
7 using System.Text;
8 using System.Threading.Tasks;
9 using System.Windows.Forms;
10

```

```

11 namespace Selection_Sort
12 {
13     public partial class Form1 : Form
14     {
15         public Form1()
16         {
17             InitializeComponent();
18         }
19
20         // The SelectionSort method accepts an int array as an argument.
21         // It uses the Selection Sort algorithm to sort the array.
22         private void SelectionSort(int[] iArray)
23         {
24             int minIndex; // Subscript of smallest value in scanned area
25             int minValue; // Smallest value in the scanned area
26
27             // The outer loop steps through all the array elements,
28             // except the last one. The startScan variable marks the
29             // position where the scan should begin.
30             for (int startScan = 0; startScan < iArray.Length - 1; startScan++)
31             {
32                 // Assume the first element in the scannable area
33                 // is the smallest value.
34                 minIndex = startScan;
35                 minValue = iArray[startScan];
36
37                 // Scan the array, starting at the 2nd element in the
38                 // scannable area, looking for the smallest value.
39                 for (int index = startScan + 1; index < iArray.Length; index++)
40                 {
41                     if (iArray[index] < minValue)
42                     {
43                         minValue = iArray[index];
44                         minIndex = index;
45                     }
46                 }
47
48                 // Swap the element with the smallest value with the
49                 // first element in the scannable area.
50                 Swap(ref iArray[minIndex], ref iArray[startScan]);
51             }
52         }
53
54         // The Swap method accepts two integer arguments, by reference,
55         // and swaps their contents.
56         private void Swap(ref int a, ref int b)
57         {
58             int temp = a;
59             a = b;
60             b = temp;
61         }
62
63         private void goButton_Click(object sender, EventArgs e)
64         {
65             // Create an array of integers.
66             int[] numbers = { 4, 6, 1, 3, 5, 2 };
67
68             // Display the array in original order.
69             foreach (int value in numbers)
70             {
71                 originalListBox.Items.Add(value);

```

```

72         }
73
74         // Sort the array.
75         SelectionSort(numbers);
76
77         // Display the array in sorted order.
78         foreach (int value in numbers)
79         {
80             sortedListBox.Items.Add(value);
81         }
82     }
83
84     private void exitButton_Click(object sender, EventArgs e)
85     {
86         // Close the form.
87         this.Close();
88     }
89 }
90 }

```

---

## The Binary Search Algorithm

Previously in this chapter we discussed the sequential search algorithm, which uses a loop to step sequentially through an array, starting with the first element. It compares each element with the value being searched for and stops when the value is found or the end of the array is encountered. If the value being searched for is not in the array, the algorithm unsuccessfully searches to the end of the array.

The advantage of the sequential search is its simplicity: It is very easy to understand and implement. Furthermore, it does not require the data in the array to be stored in any particular order. Its disadvantage, however, is its inefficiency. If the array being searched contains 20,000 elements, the algorithm has to look at all 20,000 elements in order to find a value stored in the last element.

In an average case, an item is just as likely to be found near the beginning of an array as near the end. Typically, for an array of  $n$  items, the sequential search locates an item in  $n/2$  attempts. If an array has 50,000 elements, the sequential search makes a comparison with 25,000 of them in a typical case. This is assuming, of course, that the search item is consistently found in the array. ( $n/2$  is the average number of comparisons. The maximum number of comparisons is always  $n$ .)

When the sequential search fails to locate an item, it must make a comparison with every element in the array. As the number of failed search attempts increases, so does the average number of comparisons. Although the sequential search algorithm is adequate for small arrays, it should not be used on large arrays if speed is important.

The **binary search** is a clever algorithm that is much more efficient than the sequential search. Its only requirement is that the values in the array must be sorted in ascending order. Instead of testing the array's first element, this algorithm starts with the element in the middle. If that element happens to contain the desired value, then the search is over. Otherwise, the value in the middle element is either greater than or less than the value being searched for. If it is greater, then the desired value (if it is in the list) will be found somewhere in the first half of the array. If it is less, then the desired value (again, if it is in the list) will be found somewhere in the last half of the array. In either case, half of the array's elements have been eliminated from further searching.

If the desired value is not found in the middle element, the procedure is repeated for the half of the array that potentially contains the value. For instance, if the last half of the array is to be searched, the algorithm tests *its* middle element. If the desired value is not

found there, the search is narrowed to the quarter of the array that resides before or after that element. This process continues until the value being searched for is either found or there are no more elements to test.

Here is the pseudocode for a method that performs a binary search on an array:

```

Method BinarySearch(array, searchValue)
  Set first to 0
  Set last to the last subscript in the array
  Set position to -1
  Set found to false

  While found is not true and first is less than or equal to last
    Set middle to the subscript half way between array[first] and array[last]
    If array[middle] equals searchValue
      Set found to true
      Set position to middle
    Else If array[middle] is greater than searchValue
      Set last to middle - 1
    Else
      Set first to middle + 1
    End If
  End While

  Return position
End Method

```

This algorithm uses three variables to mark positions within the array: *first*, *last*, and *middle*. The *first* and *last* variables mark the boundaries of the portion of the array currently being searched. They are initialized with the subscripts of the array's first and last elements. The subscript of the element halfway between first and last is calculated and stored in the *middle* variable. If the element in the middle of the array does not contain the search value, the *first* or *last* variable is adjusted so that only the top or bottom half of the array is searched during the next iteration. This cuts the portion of the array being searched in half each time the loop fails to locate the search value.

The following C# method performs a binary search on an integer array. The first parameter, *iArray*, is searched for an occurrence of the number stored in *value*. If the number is found, its array subscript is returned. Otherwise, -1 is returned, indicating the value did not appear in the array.

```

1 private int BinarySearch(int[] iArray, int value)
2 {
3     int first = 0;           // First array element
4     int last = iArray.Length - 1; // Last array element
5     int middle;             // Midpoint of search
6     int position = -1;      // Position of search value
7     bool found = false;    // Flag
8
9     // Search for the value.
10    while (!found && first <= last)
11    {
12        // Calculate the midpoint.
13        middle = (first + last) / 2;
14
15        // If value is found at midpoint . . .
16        if (iArray[middle] == value)
17        {
18            found = true;
19            position = middle;

```

```

20     }
21     // else if value is in lower half . . .
22     else if (iArray[middle] > value)
23     {
24         last = middle - 1;
25     }
26     // else if value is in upper half . . .
27     else
28     {
29         first = middle + 1;
30     }
31 }
32
33 // Return the position of the item, or -1
34 // if it was not found.
35 return position;
36 }

```

If you want to see a complete application that uses the binary search algorithm, look at the *Binary Search* project, located in the *Chap07* folder of the Student Sample Programs. It loads a list of names from a file into an array and then performs a binary search to find a specific name in the array.



### Checkpoint

- 7.14 What is a search algorithm?
- 7.15 What is the purpose of a sorting algorithm?
- 7.16 What is the only requirement of the binary search algorithm?

## 7.7 Two-Dimensional Arrays

**CONCEPT:** A two-dimensional array is like several identical arrays put together. It is useful for storing multiple sets of data.

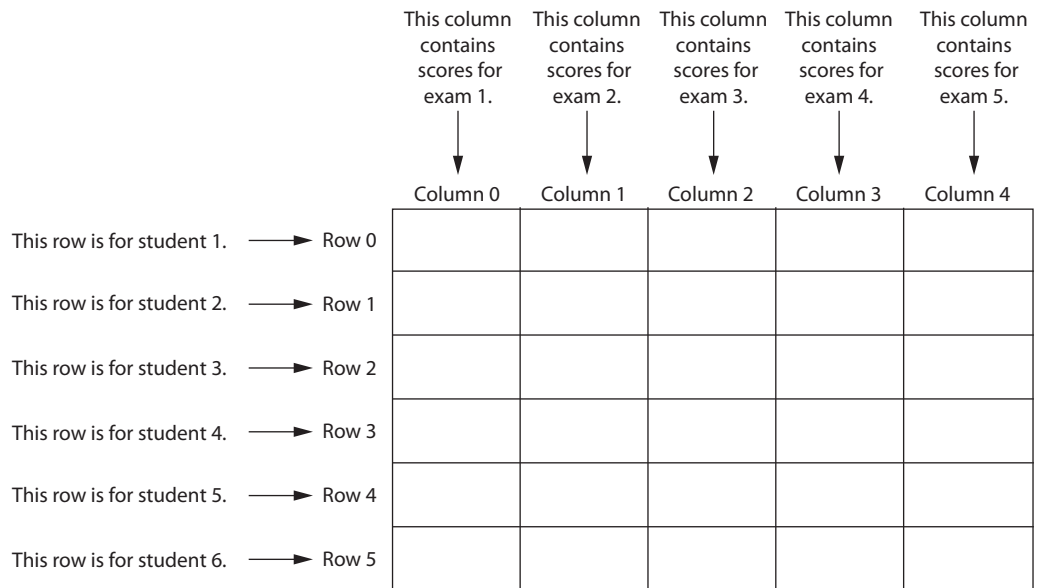
The arrays that you have studied so far are known as one-dimensional arrays. They are called **one-dimensional** arrays because they can hold only one set of data. **Two-dimensional** arrays, which are also called *2D arrays*, can hold multiple sets of data. Think of a two-dimensional array as having rows and columns of elements, as shown in Figure 7-37. This figure shows a two-dimensional array having three rows and four columns. Notice that the rows are numbered 0, 1, and 2, and the columns are numbered 0, 1, 2, and 3. There is a total of 12 elements in the array.

**Figure 7-37** A two-dimensional array

	Column 0	Column 1	Column 2	Column 3
Row 0				
Row 1				
Row 2				

Two-dimensional arrays are useful for working with multiple sets of data. For example, suppose you are designing a grade-averaging program for a teacher. The teacher has six students, and each student takes five exams during the semester. One approach would be to create six one-dimensional arrays, one for each student. Each of these arrays would have five elements, one for each exam score. This approach would be cumbersome, however, because you would have to separately process each of the arrays. A better approach would be to use a two-dimensional array with six rows (one for each student) and five columns (one for each exam score), as shown in Figure 7-38.

**Figure 7-38** Two-dimensional array with six rows and five columns



## Declaring a Two-Dimensional Array

To declare a two-dimensional array, two size declarators are required: The first one is for the number of rows, and the second one is for the number of columns. Here is an example declaration of a two-dimensional array with three rows and four columns:

```
double[,] scores = new double[3, 4];
```

Notice the comma that appears inside the first set of brackets. This indicates that the `scores` variable references a two-dimensional array. The numbers 3 and 4 are size declarators. The first size declarator specifies the number of rows, and the second size declarator specifies the number of columns. Notice that the size declarators are separated by a comma.

As with one-dimensional arrays, it is best to use named constants as the size declarators. Here is an example:

```
const int ROWS = 3;
const int COLS = 4;
int[,] scores = new int[ROWS, COLS];
```

When processing the data in a two-dimensional array, each element has two subscripts: one for its row and another for its column. In the `scores` array, the elements in row 0 are referenced as follows:

```
scores[0,0]
scores[0,1]
scores[0,2]
scores[0,3]
```

The elements in row 1 are referenced as follows:

```
scores[1,0]
scores[1,1]
scores[1,2]
scores[1,3]
```

And, the elements in row 2 are referenced as follows:

```
scores[2,0]
scores[2,1]
scores[2,2]
scores[2,3]
```

Figure 7-39 illustrates the array with the subscripts shown for each element.

**Figure 7-39** Subscripts for each element of the `scores` array

	Column 0	Column 1	Column 2	Column 3
Row 0	scores[0,0]	scores[0,1]	scores[0,2]	scores[0,3]
Row 1	scores[1,0]	scores[1,1]	scores[1,2]	scores[1,3]
Row 2	scores[2,0]	scores[2,1]	scores[2,2]	scores[2,3]

## Accessing the Elements in a Two-Dimensional Array

To access one of the elements in a two-dimensional array, you must use two subscripts. For example, suppose we have the following declarations in a program:

```
const int ROWS = 5;
const int COLS = 10;
int[,] values = new int[ROWS, COLS];
```

The following statement assigns the number 95 to `values[2,1]`:

```
values[2,1] = 95;
```

Programs often use nested loops to process two-dimensional arrays. For example, the following code assigns a random number to each element of the `values` array:

```
1 // Create a Random object.
2 Random rand = new Random();
3
4 // Create a two-dimensional int array.
5 const int ROWS = 5;
6 const int COLS = 10;
7 int[,] values = new int[ROWS, COLS];
8
9 // Fill the array with random numbers.
10 for (int row = 0; row < ROWS; row++)
11 {
12     for (int col = 0; col < COLS; col++)
13     {
14         values[row, col] = rand.Next(100);
15     }
16 }
```

And the following set of nested loops displays all the elements of the `values` array in a `ListBox` control named `outputListBox`:

```

1 // Display the array contents.
2 for (int row = 0; row < ROWS; row++)
3 {
4     for (int col = 0; col < COLS; col++)
5     {
6         outputListBox.Items.Add(values[row, col].ToString());
7     }
8 }

```

## Implicit Sizing and Initialization of Two-Dimensional Arrays

As with a one-dimensional array, you may provide an initialization list for a two-dimensional array. Recall that when you provide an initialization list for an array, you cannot provide the upper subscript numbers. When initializing a two-dimensional array, you must provide the comma to indicate the number of dimensions. The following is an example of a two-dimensional array declaration with an initialization list:

```

int[,] values = { {1, 2, 3},
                  {4, 5, 6},
                  {7, 8, 9} };

```

Initialization values for each row are enclosed in their own set of braces. In this example, the initialization values for row 0 are {1, 2, 3}, the initialization values for row 1 are {4, 5, 6}, and the initialization values for row 2 are {7, 8, 9}. So, this statement declares an array with three rows and three columns. The values are assigned to the `values` array in the following manner:

```

values[0, 0] is set to 1.
values[0, 1] is set to 2.
values[0, 2] is set to 3.
values[1, 0] is set to 4.
values[1, 1] is set to 5.
values[1, 2] is set to 6.
values[2, 0] is set to 7.
values[2, 1] is set to 8.
values[2, 2] is set to 9.

```

Tutorial 7-3 gives you hands-on practice working with a two-dimensional array.



### Tutorial 7-3: Completing the *Seating Chart* Application



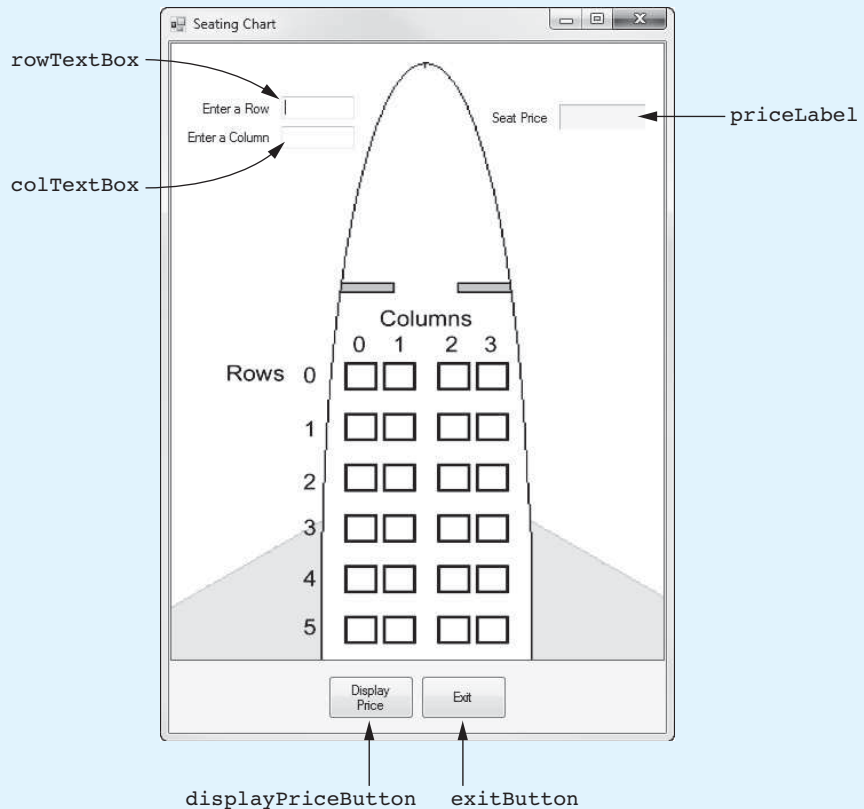
VideoNote

**Tutorial 7-3:**  
Completing the *Seating Chart* application

In this tutorial, you complete the *Seating Chart* application. The application's form, which is shown in Figure 7-40, uses a `PictureBox` control to display an airplane seating chart that is arranged in rows and columns. When completed, the application allows the user to enter valid row and column numbers in the `rowTextBox` and `colTextBox` text boxes and then click the *Display Price* button. The price of the selected seat will be displayed in the `priceLabel` control. The following table shows the seat prices:



**Figure 7-40** The *Seating Chart* application's form



Columns	0	1	2	3
Row 0	\$450	\$450	\$450	\$450
Row 1	\$425	\$425	\$425	\$425
Row 2	\$400	\$400	\$400	\$400
Row 3	\$375	\$375	\$375	\$375
Row 4	\$375	\$375	\$375	\$375
Row 5	\$350	\$350	\$350	\$350

When you write the code for the application, you will create a two-dimensional array to hold these values.

**Step 1:** Start Visual Studio (or Visual Studio Express). Open the project named *Seating Chart* in the *Chap07* folder of this book's Student Sample Programs.

**Step 2:** Open the Form1 form in the *Designer*. Double-click the `displayPriceButton` control. This opens the code editor, and you will see an empty event handler named `displayPriceButton_Click`. Complete the event handler by typing the code shown in lines 22–78 in Program 7-4. Let's take a closer look at the code:

**Line 23:** This statement declares two `int` variables, `row` and `col`, to hold the row and column selected by the user.

**Lines 26–27:** These statements declare `int` constants named `MAX_ROW` and `MAX_COL`, set to the values 5 and 3, respectively. These are used as array size declarators.

**Lines 30–36:** This statement creates a two-dimensional `decimal` array named `prices`, initialized with the seat prices previously shown.

**Line 39:** This `if` statement converts the value entered into the `rowTextBox` control to an `int` and stores the result in the `row` variable. If the conversion is successful, the program continues. If the conversion fails, the program jumps to the `else` clause in line 74, and then line 77 displays an error message.


**Line 42:** This `if` statement converts the value entered into the `colTextBox` control to an `int` and stores the result in the `col` variable. If the conversion is successful, the program continues. If the conversion fails, the program jumps to the `else` clause in line 68, and then line 71 displays an error message.

**Line 45:** This `if` statement determines whether `row` is in the range of 0 through `MAX_ROW`. If so, the program continues. Otherwise, the program jumps to the `else` clause in line 61, and then lines 64–65 display an error message.

**Line 48:** This `if` statement determines whether `col` is in the range of 0 through `MAX_COL`. If so, the program continues. Otherwise, the program jumps to the `else` clause in line 54, and then lines 57–58 display an error message.

**Lines 51–52:** This statement uses `row` and `col` as subscripts to retrieve the selected seat's price from the `prices` array and then displays that value in the `priceLabel` control.

**Step 3:** Switch your view back to the *Designer* and double-click the `exitButton` control. In the code editor you will see an empty event handler named `exitButton_Click`. Complete the event handler by typing the code shown in lines 83–84 in Program 7-4.

**Step 4:** Save the project. Then, press `[F5]` on the keyboard or click the *Start Debugging* button  on the toolbar to compile and run the application. When the application runs, experiment by entering row and column numbers for different seats and comparing the displayed price with the table previously shown. When you are finished, click the *Exit* button to end the application.

---

#### Program 7-4 Completed code for Form1 in the *Seating Chart* application

```

1 using System;
2 using System.Collections.Generic;
3 using System.ComponentModel;
4 using System.Data;
5 using System.Drawing;
6 using System.Linq;
7 using System.Text;
8 using System.Threading.Tasks;
9 using System.Windows.Forms;
10
11 namespace Seating_Chart
12 {
13     public partial class Form1 : Form
14     {
15         public Form1()
16         {
17             InitializeComponent();
18         }
19
20         private void displayPriceButton_Click(object sender, EventArgs e)

```

```

21     {
22         // Variables for the selected row and column
23         int row, col;
24
25         // Constants for the maximum row and column subscripts
26         const int MAX_ROW = 5;
27         const int MAX_COL = 3;
28
29         // Create an array with the seat prices.
30         decimal[,] prices = { {450m, 450m, 450m, 450m},
31                               {425m, 425m, 425m, 425m},
32                               {400m, 400m, 400m, 400m},
33                               {375m, 375m, 375m, 375m},
34                               {375m, 375m, 375m, 375m},
35                               {350m, 350m, 350m, 350m}
36                               };
37
38         // Get the selected row number.
39         if (int.TryParse(rowTextBox.Text, out row))
40         {
41             // Get the selected column number.
42             if (int.TryParse(colTextBox.Text, out col))
43             {
44                 // Make sure the row is within range.
45                 if (row >= 0 && row <= MAX_ROW)
46                 {
47                     // Make sure the column is within range.
48                     if (col >= 0 && col <= MAX_COL)
49                     {
50                         // Display the selected seat's price.
51                         priceLabel.Text =
52                             prices[row, col].ToString("c");
53                     }
54                     else
55                     {
56                         // Error message for invalid column.
57                         MessageBox.Show("Column must be 0 through " +
58                             MAX_COL);
59                     }
60                 }
61                 else
62                 {
63                     // Error message for invalid row.
64                     MessageBox.Show("Row must be 0 through " +
65                         MAX_ROW);
66                 }
67             }
68             else
69             {
70                 // Display an error message for noninteger column.
71                 MessageBox.Show("Enter an integer for the column.");
72             }
73         }
74         else
75         {
76             // Display an error message for noninteger row.
77             MessageBox.Show("Enter an integer for the row.");
78         }
79     }
80

```

```

81     private void exitButton_Click(object sender, EventArgs e)
82     {
83         // Close the form.
84         this.Close();
85     }
86 }
87 }

```

## Summing All the Elements of a Two-Dimensional Array

To sum all the elements of a two-dimensional array, you can use a pair of nested loops to add the contents of each element to an accumulator. The following code shows an example:

```

1 const int ROWS = 3;
2 const int COLS = 3;
3 int[,] numbers = { {1, 2, 3, 4},
4                   {5, 6, 7, 8},
5                   {9, 10, 11, 12}
6                   };
7
8 int total = 0; // Accumulator, set to 0
9
10 // Sum the array elements.
11 for (int row = 0; row < ROWS; row++)
12 {
13     for (int col = 0; col < COLS; col++)
14     {
15         total += numbers[row, col];
16     }
17 }
18 // Display the sum.
19 MessageBox.Show("The total is " + total);

```

## Summing the Rows of a Two-Dimensional Array

Sometimes you may need to calculate the sum of each row in a two-dimensional array. For example, suppose a two-dimensional array is used to hold a set of test scores for a set of students. Each row in the array is a set of test scores for one student. To get the sum of a student's test scores (perhaps so an average may be calculated), you use a loop to add all the elements in one row. The following code shows an example:

```

1 const int ROWS = 3;
2 const int COLS = 3;
3 int[,] numbers = { {1, 2, 3, 4},
4                   {5, 6, 7, 8},
5                   {9, 10, 11, 12}
6                   };
7
8 int total; // Accumulator
9
10 // Sum each row in the array.
11 for (int row = 0; row < ROWS; row++)
12 {
13     // Set the accumulator to 0.
14     total = 0;
15
16     // Total the row.
17     for (int col = 0; col < COLS; col++)

```

```

18     {
19         total += numbers[row, col];
20     }
21
22     // Display the row's total.
23     MessageBox.Show("The total of row " + row +
24                     " is " + total);
25 }

```

## Summing the Columns of a Two-Dimensional Array

Sometimes you may need to calculate the sum of each column in a two-dimensional array. For example, suppose a two-dimensional array is used to hold a set of test scores for a set of students and you wish to calculate the class average for each of the test scores. To do this, you calculate the average of each column in the array. This is accomplished with a set of nested loops. The outer loop controls the column subscript, and the inner loop controls the row subscript. The inner loop calculates the sum of a column, which is stored in an accumulator. The following code demonstrates:

```

1 const int ROWS = 3;
2 const int COLS = 4;
3 int[,] numbers = { {1, 2, 3, 4},
4                   {5, 6, 7, 8},
5                   {9, 10, 11, 12}
6                   };
7
8 int total; // Accumulator
9
10 // Sum each column in the array.
11 for (int col = 0; col < COLS; col++)
12 {
13     // Set the accumulator to 0.
14     total = 0;
15
16     // Total the column.
17     for (int row = 0; row < ROWS; row++)
18     {
19         total += numbers[row, col];
20     }
21
22     // Display the column's total.
23     MessageBox.Show("The total of column " + col +
24                     " is " + total);
25 }

```



### Checkpoint

7.17 How many rows and how many columns are in the following array?

```
int[, ] values = new decimal[200, 100];
```

7.18 Write a statement that assigns the value 50 to the very last element in the values array declared in Checkpoint 7.17.

7.19 Write a declaration for a two-dimensional int array initialized with the following table of data:

12	24	32	21	42
99	8	68	32	92
95	34	21	11	7

## 7.8 Jagged Arrays

**CONCEPT:** A jagged array is similar to a two-dimensional array, but the rows in a jagged array can have different lengths.

In a traditional two-dimensional array, each row has the same number of columns. Mentally, we visualize a two-dimensional array as a rectangular structure. Figure 7-37, previously shown, is an example. For this reason, two-dimensional arrays are sometimes referred to as **rectangular arrays**.

A **jagged array** is similar to a two-dimensional array, but the rows in a jagged array can have different numbers of columns. This is possible because a jagged array is actually an array of arrays. To be more specific, a jagged array is a one-dimensional array, and each element of the array is also a one-dimensional array. Figure 7-41 shows an example. In the figure, row 0 has four columns, row 1 has three columns, and row 2 has five columns.

**Figure 7-41** A jagged array

Row 0	1	2	3	4	
Row 1	5	6	7		
Row 2	8	9	10	11	12

Because a jagged array is an array of arrays, you set it up differently than a two-dimensional array. First you create an array, and then you create each of the arrays that are the elements of the first array. The following code shows an example of how the jagged array in Figure 7-41 might be created and initialized.

```

1 // Create an array of 3 int arrays.
2 int[][] jaggedArray = new int[3][];
3
4 // Create each array that is an element
5 // of the jagged array.
6 jaggedArray[0] = new int[4] { 1, 2, 3, 4 };
7 jaggedArray[1] = new int[3] { 5, 6, 7 };
8 jaggedArray[2] = new int[5] { 8, 9, 10, 11, 12 };

```

Let's take a closer look at the code:

- Line 2 declares an array named `jaggedArray`. Notice that the data type is `int[][]`, with two sets of brackets. This indicates that we are declaring an array of `int` arrays. Also notice that the expression `new int[3][]` uses only one size declarator, specifying the number of rows. The column sizes must be set individually.
- Line 6 creates element 0, which is an `int` array with four columns. The columns are initialized with the values 1, 2, 3, and 4.
- Line 7 creates element 1, which is an `int` array with three columns. The columns are initialized with the values 5, 6, and 7.
- Line 8 creates element 2, which is an `int` array with five columns. The columns are initialized with the values 8, 9, 10, 11, and 12.

To access an item that is stored at a particular row and column in a jagged array, you enclose the row and column subscripts in their own sets of brackets. For example, the following

statement displays the value stored at row 1, column 2, of the `jaggedArray` that was previously declared:

```
MessageBox.Show(jaggedArray[1][2].ToString());
```

The following statement shows another example. It assigns the value 99 to row 0, column 3, of `jaggedArray`:

```
jaggedArray[0][3] = 99;
```

A jagged array has a `Length` property that holds the number of rows, and then each row has its own `Length` property. You can use a row's `Length` property to determine the number of columns in that row. For example, the following set of nested loops displays all the values stored in the `jaggedArray` that was previously declared:

```
1 for (int row = 0; row < jaggedArray.Length; row++)
2 {
3     for (int col = 0; col < jaggedArray[row].Length; col++)
4     {
5         MessageBox.Show(jaggedArray[row][col].ToString());
6     }
7 }
```



## Checkpoint

- 7.20 Why are two-dimensional arrays sometimes referred to as rectangular arrays?
- 7.21 Write a statement that declares a jagged array of `int` values and initialize the columns of each row with the values in the following table of data:

2	4	6		
3	5	7	9	
5	9	11	17	21

## 7.9 The List Collection

**CONCEPT:** `List` is a class in the .NET Framework that is similar to an array. Unlike an array, a `List` object's size is automatically adjusted to accommodate the number of items being stored in it.

The .NET Framework provides a class named `List`, which can be used for storing and retrieving items. Once you create a `List` object, you can think of it as a container for holding other objects. A `List` object is similar to an array but offers many advantages over an array. Here are a few:

- When you create a `List` object, you do not have to know the number of items that you intend to store in it.
- A `List` object automatically expands as items are added to it.
- In addition to adding items to a `List`, you can remove items as well.
- A `List` object automatically shrinks as items are removed from it.

### Creating a List

Here is an example of how you create a `List` object that can be used to hold strings:

```
List<string> nameList = new List<string>();
```

This statement creates a `List` object, referenced by the `nameList` variable. Notice that in this example the word `string` is written inside angled brackets `<>` immediately after the word `List`. This specifies that the `List` can hold objects of the `string` data type. If you try to store any other type of object in this `List`, an error occurs.

Here is an example of how you create a `List` object that can be used to hold integers:

```
List<int> numberList = new List<int>();
```

This statement creates a `List` object, referenced by the `numberList` variable. Notice that in this example the word `int` is written inside angled brackets `<>` immediately after the word `List`.

## Initializing a List

You can optionally initialize a `List` object when you declare it. Here is an example:

```
List<int> numberList = new List<int>() { 1, 2, 3 };
```

This statement creates a `List` object that can hold integers and initializes it with the values 1, 2, and 3. Here is an example that creates a `List` object to hold strings and initializes it with three strings:

```
List<string> nameList = new List<string>() { "Chris",  
    "Kathryn", "Bill" };
```

## Adding Items to a List

To add items to an existing `List` object, you use the **add method**. For example, the following statements create a `List` object and add a series of strings to it:

```
List<string> nameList = new List<string>();  
nameList.Add("Chris");  
nameList.Add("Kathryn");  
nameList.Add("Bill");
```

After these statements execute, the `nameList` object will hold the three strings "Chris", "Kathryn", and "Bill".

The items that are stored in a `List` have a corresponding index. The index specifies the item's location in the `List`, so it is much like an array subscript. The first item that is added to a `List` is stored at index 0. The next item that is added to the `List` is stored at index 1, and so forth. After the previously shown statements execute, "Chris" is stored at index 0, "Kathryn" is stored at index 1, and "Bill" is stored at index 2.

## The Count Property

A `List` object has a **Count property** that holds the number of items stored in the `List`. For example, the following statement uses the `Count` property to display the number of items stored in `nameList`:

```
MessageBox.Show("The List has " + nameList.Count +  
    " objects stored in it.");
```

Assuming that `nameList` holds the strings "Chris", "Kathryn", and "Bill", the following statement will be displayed in a message box:

```
The List has 3 objects stored in it.
```



## Accessing Items in a List

You can use subscript notation to access the items in a `List`, just as you can with an array. For example, the following `for` loop displays the items in the `nameList` object:

```
for (int index = 0; index < nameList.Count; index++)
{
    MessageBox.Show(nameList[index]);
}
```

Notice that the loop uses the `List` object's `Count` property in the test expression to control the number of iterations. Here is an example that reads values from a text file and adds them to a `List`:

```
1 // Open the Names.txt file.
2 StreamReader inputFile = File.OpenText("Names.txt");
3
4 // Create a List object to hold strings.
5 List<string> nameList = new List<string>();
6
7 // Read the file's contents.
8 while (!inputFile.EndOfStream)
9 {
10     // Read a line and add it to the List.
11     nameList.Add(inputFile.ReadLine());
12 }
```

Let's take a closer look at this code:

- Line 2 opens a file named `Names.txt` and associates it with a `StreamReader` object that is referenced by the `inputFile` variable.
- Line 5 creates a `List` object, referenced by the `nameList` variable. The object can hold strings.
- The `while` loop that starts in line 8 iterates until the end of the file is reached.
- The statement in line 11 reads a line from the file and adds it to the `nameList` object.

After this code executes, the `nameList` object contains all the lines that were read from the `Names.txt` file.

You can also use the `foreach` loop to iterate over the items in a `List`, just as you can with an array. Here is an example:

```
foreach (string str in nameList)
{
    MessageBox.Show(str);
}
```

## Passing a List to a Method

Sometimes you will want to write a method that accepts a `List` as an argument and performs an operation on the `List`. For example, the following code shows a method named `DisplayList`. The method accepts a `List` of strings as an argument and displays each item in `List`.

```
1 private void DisplayList(List<string> sList)
2 {
3     foreach (string str in sList)
4     {
5         MessageBox.Show(str);
6     }
7 }
```

Notice in line 1 that the method has a parameter variable named `sList` and that the parameter's data type is `List<string>`. The parameter variable is a reference to a `List<string>` object. When you call this method, you must pass a `List<string>` object as an argument.

When you call a method and pass a `List<string>` object as an argument, you simply pass the variable that references the `List`. The following code shows an example of how the `DisplayList` method (previously shown) might be called:

```
1 // Create a List of strings.
2 List<string> nameList = new List<string>() { "Chris",
3     "Kathryn", "Bill" };
4
5 // Pass the List to the DisplayList method.
6 DisplayList(nameList);
```

The statement in lines 2 and 3 creates a `List` containing the strings "Chris", "Kathryn", and "Bill". Line 6 calls the `DisplayList` method, passing the `nameList` object as an argument.



**NOTE:** List objects, like arrays, are always passed by reference.

## Removing Items from a List

You can use the **RemoveAt** method to remove an item at a specific index in a `List`. The following code shows an example:

```
1 // Create a List of strings.
2 List<string> nameList = new List<string>() { "Chris",
3     "Kathryn", "Bill" };
4
5 // Remove the item at index 0.
6 nameList.RemoveAt(0);
```

The statement in lines 2 and 3 creates a `List` containing the strings "Chris", "Kathryn", and "Bill". Then, the statement in line 6 removes the string at index 0. After this statement executes, the `List` contains the strings "Kathryn" and "Bill".

If you know the value of the item that you want to remove from a `List`, but you do not know the item's index, you can use the **Remove** method. You pass the item that you want to remove as an argument, and the `Remove` method searches for that item in the `List`. If the item is found, it is removed. Here is an example:

```
1 // Create a List of strings.
2 List<string> nameList = new List<string>() { "Chris",
3     "Kathryn", "Bill" };
4
5 // Remove "Bill" from the List.
6 nameList.Remove("Bill");
```

The statement in lines 2 and 3 creates a `List` containing the strings "Chris", "Kathryn", and "Bill". Then, the statement in line 6 removes "Bill" from the `List`. After this statement executes, the `List` contains the strings "Chris" and "Kathryn".

The `Remove` method returns a Boolean value indicating whether the item was actually removed from the `List`. If the specified item was found in the `List` and removed, the `Remove` method returns `true`. If the item was not found in the `List`, the `Remove` method returns

false. The following code demonstrates how you can use the value returned from the method:

```

1 // Create a List of strings.
2 List<string> nameList = new List<string>() { "Chris",
3     "Kathryn", "Bill" };
4
5 // Remove "Susan".
6 if (!nameList.Remove("Susan"))
7 {
8     MessageBox.Show("Susan was not found.");
9 }

```

The statement in lines 2 and 3 creates a `List` containing the strings "Chris", "Kathryn", and "Bill". Then, the statement in line 6 attempts to remove "Susan" from the `List`. The `List` does not contain the string "Susan", so the `Remove` method returns `false`. The message "Susan was not found" is displayed. After this code executes, the `List` still contains the strings "Chris", "Kathryn", and "Bill".



**NOTE:** The `Remove` method performs a sequential search to locate the specified item. If the `List` contains a large number of items, its performance will be slow.

If you want to remove all the items from a `List`, you can call the **Clear** method. Here is an example:

```
nameList.Clear();
```

After this statement executes, the `nameList` object is empty.

## Inserting an Item

You can use the **Insert** method to insert an item at a specific index in a `List`. The following code shows an example:

```

1 // Create a List of strings.
2 List<string> nameList = new List<string>() { "Chris",
3     "Kathryn", "Bill" };
4
5 // Insert an item at index 0.
6 nameList.Insert("Joanne", 0);

```

The statement in lines 2 and 3 creates a `List` containing the strings "Chris", "Kathryn", and "Bill". Then, the statement in line 6 inserts the string "Joanne" at index 0. After this statement executes, the `List` contains the strings "Joanne", "Chris", "Kathryn", and "Bill".



**NOTE:** An exception will occur if the specified index is less than 0 or greater than the `List` object's `Count` property.

## Searching for Items in a List

Because you can use subscript notation to access the items in a `List`, you can adapt any of the array-processing algorithms that you saw earlier in this chapter so they work with a `List`. For example, you can write code that performs a sequential search, binary search, selection sort, and so on, on a `List`.

An easy way to search for item in a `List`, however, is to use the `IndexOf` method. The `IndexOf` method accepts a value as an argument, and it searches for that value in the `List`. If the value is found, the method returns its index. If the value is not found, the method returns `-1`. The following code shows an example:

```

1 // Create a List of strings.
2 List<string> nameList = new List<string>() { "Chris",
3     "Kathryn", "Bill" };
4
5 // Search for "Kathryn".
6 int position = nameList.IndexOf("Kathryn");
7
8 // Was Kathryn found in the List?
9 if (position != -1)
10 {
11     MessageBox.Show("Kathryn was found at index " +
12         position);
13 }
14 else
15 {
16     MessageBox.Show("Kathryn was not found.");
17 }

```

The statement in lines 2 and 3 creates a `List` containing the strings "Chris", "Kathryn", and "Bill". The statement in line 6 calls the `IndexOf` method to search for "Kathryn" in the `List`. The value that is returned from the method is assigned to the `position` variable. After this statement executes, the `position` variable contains the index of "Kathryn" or `-1` if "Kathryn" was not found in the `List`. The `if` statement in lines 9–17 displays one of two possible messages, depending on whether "Kathryn" was found. (If this code were executed, it would display the message "Kathryn was found at index 1".)

There are two additional versions of the `IndexOf` method that allow you to specify the area of the `List` that should be searched. The following statement shows an example of one of these:

```
position = nameList.IndexOf("Diane", 2);
```

Notice that two arguments are passed to the `IndexOf` method. The first argument, "Diane", is the item to search for. The second argument, 2 is the starting index of the search. This specifies that the search should begin at index 2 and end at the last item in the `List`. (The beginning index is included in the search. If you pass an invalid index as an argument, an exception occurs.)

Here is an example of another version of the `IndexOf` method:

```
position = nameList.IndexOf("Diane", 2, 5);
```

In this example, three arguments are passed to the `IndexOf` method. The first argument, "Diane", is the item to search for. The second argument, 2 is the starting index of the search. The third argument, 5, is the ending index of the search. This specifies that the search should begin at index 2, and end at index 5. (The beginning and ending indices are included in the search. If either index is invalid, an exception occurs.)



**NOTE:** The `IndexOf` method performs a sequential search to locate the specified item. If the `List` contains a large number of items, its performance will be slow.

In Tutorial 7-4 you will complete an application that reads the contents of a file into a `List`, and then performs various operations on the `List`.



VideoNote

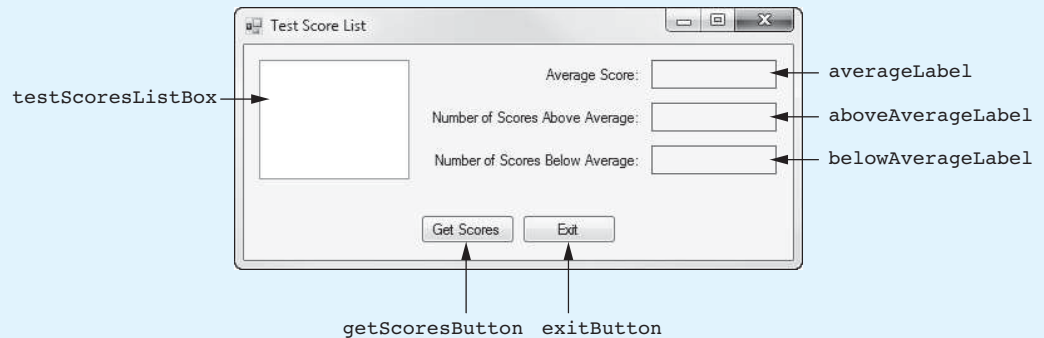
**Tutorial 7-4:**  
Completing the *Test Score List* Application



## Tutorial 7-4: Completing the *Test Score List* Application

In this tutorial, you complete the *Test Score List* application. The application's form, which is shown in Figure 7-42, has already been created for you. When you complete the application, it will read a set of test scores from a file into a `List`. (The file has also been created for you.) The test scores are displayed in the `ListBox` control. The average test score is calculated and displayed, as well as the number of above-average test scores and below-average test scores.

**Figure 7-42** The *Test Score List* application's form



- Step 1:** Start Visual Studio (or Visual Studio Express). Open the project named *Test Score List* in the *Chap07* folder of the Student Sample Programs.
- Step 2:** Open the `Form1` form's code in the code editor. Insert the `using System.IO;` directive shown in line 10 of Program 7-5 at the end of this tutorial. This statement is necessary because we will be using the `StreamReader` class, and it is part of the `System.IO` namespace in the .NET Framework.
- Step 3:** With the code editor still open, type the comments and code for the `ReadScores` method, shown in lines 21–44 of Program 7-5. The purpose of the `ReadScores` method is to accept a `List<int>` object as an argument and read the contents of the `TestScores.txt` file into the list.
- Step 4:** Type the comments and code for the `DisplayScores` method, shown in lines 46–54 of Program 7-5. The purpose of the `DisplayScores` method is to accept a `List<int>` object as an argument and display its contents in the `testScoresListBox` control.
- Step 5:** Type the comments and code for the `Average` method, shown in lines 56–74 of Program 7-5. The purpose of the `Average` method is to accept a `List<int>` object as an argument and return the average of the values in the `List`.
- Step 6:** Type the comments and code for the `AboveAverage` method, shown in lines 76–96 of Program 7-5. The purpose of the `AboveAverage` method is to accept a `List<int>` object as an argument and return the number of above average scores it contains.
- Step 7:** Type the comments and code for the `BelowAverage` method, shown in lines 98–118 of Program 7-5. The purpose of the `BelowAverage` method is to accept a `List<int>` object as an argument and return the number of below average scores it contains.

**Step 8:** Next, you create the Click event handlers for the Button controls. Switch back to the *Designer* and double-click the `getScoresButton` control. This opens the code editor, and you will see an empty event handler named `getScoresButton_Click`. Complete the `getScoresButton_Click` event handler by typing the code shown in lines 122–145 in Program 7-5. Let’s review this code:

**Lines 122–124:** These statements declare the following variables:

- `averageScore`—This variable is used to hold the average test score.
- `numAboveAverage`—This variable is used to hold the number of above-average test scores.
- `numBelowAverage`—This variable is used to hold the number of below-average test scores.

**Line 127:** This statement creates a `List<int>` object, referenced by the `scoresList` variable.

**Line 130:** This statement calls the `ReadScores` method, passing the `scoresList` object as an argument. After this statement executes, the `scoresList` object contains the test scores that are in the `TestScores.txt` file.

**Line 133:** This statement calls the `DisplayScores` method, passing the `scoresList` object as an argument. After this statement executes, the items in the `scoresList` object are displayed in the `testScoresListBox` control.

**Line 136:** This statement calls the `Average` method, passing the `scoresList` object as an argument. The method returns the average of the values in the `scoresList` object, which is assigned to the `averageScore` variable.

**Line 137:** This statement displays the average score in the `averageLabel` control.

**Line 140:** This statement calls the `AboveAverage` method, passing the `scoresList` object as an argument. The method returns the number of above-average scores in the `scoresList` object, which is assigned to the `numAboveAverage` variable.

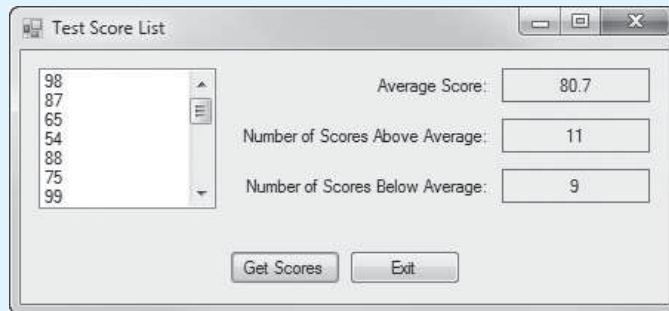
**Line 141:** This statement displays the number of above-average scores in the `aboveAverageLabel` control.

**Line 144:** This statement calls the `BelowAverage` method, passing the `scoresList` object as an argument. The method returns the number of below-average scores in the `scoresList` object, which is assigned to the `numBelowAverage` variable.

**Line 145:** This statement displays the number of below-average scores in the `belowAverageLabel` control.

**Step 9:** Switch your view back to the *Designer* and double-click the `exitButton` control. In the code editor you will see an empty event handler named `exitButton_Click`. Complete the event handler by typing the code shown in lines 150–151 in Program 7-5.

**Step 10:** Save the project. Then, press `[F5]` on the keyboard or click the *Start Debugging* button (▶) on the toolbar to compile and run the application. When the application runs, click the *Get Scores* button. This should display a set of test scores in the `ListBox`, as well as the average score, the number of above-average scores, and the number of below-average scores, as shown in Figure 7-43. Click the *Exit* button to exit the application.

**Figure 7-43** The *Test Score List* application**Program 7-5** Completed code for Form1 in the *Test Scores List* application

```

1 using System;
2 using System.Collections.Generic;
3 using System.ComponentModel;
4 using System.Data;
5 using System.Drawing;
6 using System.Linq;
7 using System.Text;
8 using System.Threading.Tasks;
9 using System.Windows.Forms;
10 using System.IO;
11
12 namespace Test_Score_List
13 {
14     public partial class Form1 : Form
15     {
16         public Form1()
17         {
18             InitializeComponent();
19         }
20
21         // The ReadScores method reads the scores from the
22         // TestScores.txt file into the scoresList parameter.
23         private void ReadScores(List<int> scoresList)
24         {
25             try
26             {
27                 // Open the TestScores.txt file.
28                 StreamReader inputFile = File.OpenText("TestScores.txt");
29
30                 // Read the scores into the list.
31                 while (!inputFile.EndOfStream)
32                 {
33                     scoresList.Add(int.Parse(inputFile.ReadLine()));
34                 }
35
36                 // Close the file.
37                 inputFile.Close();
38             }
39             catch (Exception ex)
40             {

```

```

41         // Display an error message.
42         MessageBox.Show(ex.Message);
43     }
44 }
45
46 // The DisplayScores method displays the contents of the
47 // scoresList parameter in the ListBox control.
48 private void DisplayScores(List<int> scoresList)
49 {
50     foreach (int score in scoresList)
51     {
52         testScoresListBox.Items.Add(score);
53     }
54 }
55
56 // The Average method returns the average of the values
57 // in the scoresList parameter.
58 private double Average(List<int> scoresList)
59 {
60     int total = 0;        // Accumulator
61     double average;      // To hold the average
62
63     // Calculate the total of the scores.
64     foreach (int score in scoresList)
65     {
66         total += score;
67     }
68
69     // Calculate the average of the scores.
70     average = (double)total / scoresList.Count;
71
72     // Return the average.
73     return average;
74 }
75
76 // The AboveAverage method returns the number of
77 // above average scores in scoresList.
78 private int AboveAverage(List<int> scoresList)
79 {
80     int numAbove = 0;    // Accumulator
81
82     // Get the average score.
83     double avg = Average(scoresList);
84
85     // Count the number of above average scores.
86     foreach (int score in scoresList)
87     {
88         if (score > avg)
89         {
90             numAbove++;
91         }
92     }
93
94     // Return the number of above average scores.
95     return numAbove;
96 }
97
98 // The BelowAverage method returns the number of

```



```

99      // below average scores in scoresList.
100     private int BelowAverage(List<int> scoresList)
101     {
102         int numBelow = 0;          // Accumulator
103
104         // Get the average score.
105         double avg = Average(scoresList);
106
107         // Count the number of below average scores.
108         foreach (int score in scoresList)
109         {
110             if (score < avg)
111             {
112                 numBelow++;
113             }
114         }
115
116         // Return the number of below average scores.
117         return numBelow;
118     }
119
120     private void getScoresButton_Click(object sender, EventArgs e)
121     {
122         double averageScore;      // To hold the average score
123         int numAboveAverage;      // Number of above average scores
124         int numBelowAverage;      // Number of below average scores
125
126         // Create a List to hold the scores.
127         List<int> scoresList = new List<int>();
128
129         // Read the scores from the file into the List.
130         ReadScores(scoresList);
131
132         // Display the scores.
133         DisplayScores(scoresList);
134
135         // Display the average score.
136         averageScore = Average(scoresList);
137         averageLabel.Text = averageScore.ToString("n1");
138
139         // Display the number of above average scores.
140         numAboveAverage = AboveAverage(scoresList);
141         aboveAverageLabel.Text = numAboveAverage.ToString();
142
143         // Display the number of below average scores.
144         numBelowAverage = BelowAverage(scoresList);
145         belowAverageLabel.Text = numBelowAverage.ToString();
146     }
147
148     private void exitButton_Click(object sender, EventArgs e)
149     {
150         // Close the form.
151         this.Close();
152     }
153 }
154 }

```

 **Checkpoint**

- 7.22 Write a statement that initializes a `List` with 4 values of the `double` data type.
- 7.23 Write a statement that adds a new value to the `List` object created in Checkpoint 7.22.
- 7.24 Write a statement that clears the contents of the `List` object created in Checkpoint 7.22.
- 7.25 Is it possible to write code that performs a sequential search, binary search, selection sort, and so on, on a `List`? Why or why not?

## Key Terms

Add method	off-by-one error
array	one-dimensional
binary search	rectangular arrays
clear method	reference
Count property	reference copy
elements	reference types
foreach loop	reference variable
garbage collection	Remove method
IndexOf method	RemoveAt method
initialization list	search algorithms
Insert method	selection sort
iteration variable	sequential search algorithm
jagged array	size declarator
Length property	subscript
List	two-dimensional
new operator	value types

## Review Questions

### Multiple Choice

- The memory that is allocated for a \_\_\_\_\_ variable is the actual location that will hold any value that is assigned to that variable.
  - reference type
  - general type
  - value type
  - framework type
- A variable that is used to reference an object is commonly called a(n) \_\_\_\_\_.
  - reference variable
  - resource variable
  - object variable
  - component variable
- When you want to work with an object, you use a variable that holds a special value known as a(n) \_\_\_\_\_ to link the variable to the object.
  - union
  - reference
  - object linker
  - data coupling
- The \_\_\_\_\_ creates an object in memory and returns a reference to that object.
  - = operator
  - object allocator
  - reference variable
  - new operator
- A(n) \_\_\_\_\_ is an object that can hold a group of values that are all of the same data type.
  - array
  - collection
  - container
  - set

6. The \_\_\_\_\_ indicates the number of values that the array should be able to hold.
  - a. allocation limit
  - b. size declarator
  - c. data type
  - d. compiler
7. The storage locations in an array are known as \_\_\_\_\_.
  - a. elements
  - b. sectors
  - c. pages
  - d. blocks
8. Each element in an array is assigned a unique number known as a(n) \_\_\_\_\_.
  - a. element identifier
  - b. subscript
  - c. index
  - d. sequencer
9. When you create an array, you can optionally initialize it with a group of values called a(n) \_\_\_\_\_.
  - a. default value group
  - b. initialization list
  - c. defined set
  - d. value list
10. In C#, all arrays have a \_\_\_\_\_ that is set to the number of elements in the array.
  - a. Limit property
  - b. Size property
  - c. Length property
  - d. Maximum property
11. A(n) \_\_\_\_\_ occurs when a loop iterates one time too many or one time too few.
  - a. general error
  - b. logic error
  - c. loop count error
  - d. off-by-one error
12. C# provides a special loop that, in many circumstances, simplifies array processing. It is known as the \_\_\_\_\_.
  - a. for loop
  - b. foreach loop
  - c. while loop
  - d. do-while loop
13. The foreach loop is designed to work with a temporary, read-only variable that is known as the \_\_\_\_\_.
  - a. element variable
  - b. loop variable
  - c. index variable
  - d. iteration variable
14. \_\_\_\_\_ is a process that periodically runs, removing all unreferenced objects from memory.
  - a. Systematic reallocation
  - b. Memory cleanup

- c. Garbage collection
  - d. Object maintenance
15. Various techniques known as \_\_\_\_\_ have been developed to locate a specific item in a larger collection of data, such as an array.
    - a. seek functions
    - b. request methods
    - c. traversal procedures
    - d. search algorithms
  16. The \_\_\_\_\_ uses a loop to step through an array, starting with the first element, searching for an item.
    - a. sequential search algorithm
    - b. top-down method
    - c. ascending search algorithm
    - d. basic search function
  17. A(n) \_\_\_\_\_ is a type of assignment operation that copies a reference to an array and not the contents of the array.
    - a. object copy
    - b. reference copy
    - c. double reference
    - d. parallel copy
  18. The \_\_\_\_\_ is a clever algorithm that is much more efficient than the sequential search.
    - a. linear search
    - b. bubble sort
    - c. binary search
    - d. selection sort
  19. A \_\_\_\_\_ is similar to a two-dimensional array, but the rows can have different numbers of columns.
    - a. one-dimensional array
    - b. columnar array
    - c. jagged array
    - d. split row array
  20. The .NET Framework provides a class named \_\_\_\_\_, which can be used for storing and retrieving items.
    - a. `Matrix`
    - b. `Database`
    - c. `Container`
    - d. `List`

### True or False

1. When you are working with a value type, you are using a variable that holds a piece of data.
2. Reference variables can be used only to reference objects.
3. Individual variables are well suited for storing and processing lists of data.
4. Arrays are reference type objects.
5. You can store a mixture of data types in an array.
6. When you create a numeric array in C#, its elements are set to the value 0 by default.

7. The subscript of the last element will always be one less than the array's `Length` property.
8. You use the `==` operator to compare two array reference variables and determine whether the arrays are equal.
9. A jagged array is similar to a two-dimensional array, but the rows in a jagged array can have different numbers of columns.
10. When you create a `List` object, you do not have to know the number of items that you intend to store in it.

### Short Answer

1. How much memory is allocated by the compiler when you declare a value type variable?
2. What type of variable is needed to work with an object in code?
3. What two steps are typically required for creating a reference type object?
4. Are variables well suited for processing lists of data? Why or why not?
5. What value is returned by the `Length` property of an array?
6. What can cause an off-by-one error when working with an array?
7. How do you keep track of elements that contain data in a partially filled array?
8. Briefly describe the selection sort algorithm.
9. How is the binary search more efficient than the sequential search algorithm?
10. What advantages does a `List` have over an array?

### Algorithm Workbench

1. Assume `names` is a variable that references an array of 20 `string` values. Write a `foreach` loop that displays each of the elements of the array in a `ListBox` control.
2. The variables `numberArray1` and `numberArray2` reference arrays that have 100 elements each. Write code that copies the values from `numberArray1` to `numberArray2`.
3. Write code for a sequential search that determines whether the value `-1` is stored in an array with a reference variable named `values`. The code should display a message indicating whether the value was found.
4. Write a declaration statement that creates a two-dimensional array referenced by a variable named `grades`. The array should store `int` values using 18 rows and 12 columns.
5. Write code that sums each column in the array in Question 4.
6. Create a `List` object that uses the binary search algorithm to search for the string "A". Display a message box indicating whether the value was found.

## Programming Problems

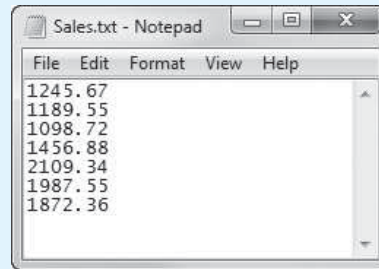
### 1. Total Sales

In the *Chap07* folder of the Student Sample Programs, you will find a file named `Sales.txt`. Figure 7-44 shows the file's contents displayed in Notepad. Create an application that reads this file's contents into an array, displays the array's contents in a `ListBox` control, and calculates and displays the total of the array's values.



VideoNote

Solving the  
Total Sales  
Problem

**Figure 7-44** The Sales.txt file

## 2. Sales Analysis

Modify the application that you created in Programming Exercise 1 so it also displays the following:

- The average of the values in the array
- The largest value in the array
- The smallest value in the array

## 3. Charge Account Validation

In the *Chap07* folder of the Student Sample Programs, you will find a file named *ChargeAccounts.txt*. The file contains a list of a company's valid charge account numbers. There are a total of 18 charge account numbers in the file, and each one is a 7-digit number, such as 5658845.

Create an application that reads the contents of the file into an array or a `List`. The application should then let the user enter a charge account number. The program should determine whether the number is valid by searching for it in the array or `List` that contains the valid charge account numbers. If the number is in the array or `List`, the program should display a message indicating the number is valid. If the number is not in the array or `List`, the program should display a message indicating the number is invalid.

## 4. Driver's License Exam

The local driver's license office has asked you to create an application that grades the written portion of the driver's license exam. The exam has 20 multiple-choice questions. Here are the correct answers:

- |       |       |       |       |       |
|-------|-------|-------|-------|-------|
| 1. B  | 2. D  | 3. A  | 4. A  | 5. C  |
| 6. A  | 7. B  | 8. A  | 9. C  | 10. D |
| 11. B | 12. C | 13. D | 14. A | 15. D |
| 16. C | 17. C | 18. B | 19. D | 20. A |

Your program should store these correct answers in an array. The program should read the student's answers for each of the 20 questions from a text file and store the answers in another array. (Create your own text file to test the application.) After the student's answers have been read from the file, the program should display a message indicating whether the student passed or failed the exam. (A student must correctly answer 15 of the 20 questions to pass the exam.) It should then display the total number of correctly answered questions, the total number of incorrectly answered questions, and a list showing the question numbers of the incorrectly answered questions.

## 5. World Series Champions

In the *Chap07* folder of the Student Sample Programs, you will find the following files:

- *Teams.txt*—This file contains a list of several Major League baseball teams in alphabetical order. Each team listed in the file has won the World Series at least once.

- **WorldSeriesWinners.txt**—This file contains a chronological list of the World Series' winning teams from 1903 through 2012. (The first line in the file is the name of the team that won in 1903, and the last line is the name of the team that won in 2012. Note that the World Series was not played in 1904 or 1994.)

Create an application that displays the contents of the `Teams.txt` file in a `ListBox` control. When the user selects a team in the `ListBox`, the application should display the number of times that team has won the World Series in the time period from 1903 through 2012.



**TIP:** Read the contents of the `WorldSeriesWinners.txt` file into a `List` or an array. When the user selects a team, an algorithm should step through the list or array counting the number of times the selected team appears.

## 6. Name Search

In the *Chap07* folder of the Student Sample Programs, you will find the following files:

- **GirlNames.txt**—This file contains a list of the 200 most popular names given to girls born in the United States from 2000 through 2009.
- **BoyNames.txt**—This file contains a list of the 200 most popular names given to boys born in the United States from 2000 through 2009.

Create an application that reads the contents of the two files into two separate arrays or `Lists`. The user should be able to enter a boy's name, a girl's name, or both, and the application should display messages indicating whether the names were among the most popular.

## 7. Population Data

In the *Chap07* folder of the Student Sample Programs, you will find a file named `USPopulation.txt`. The file contains the midyear population of the United States, in thousands, during the years 1950 through 1990. The first line in the file contains the population for 1950, the second line contains the population for 1951, and so forth. Create an application that reads the file's contents into an array or a `List`. The application should display the following data:

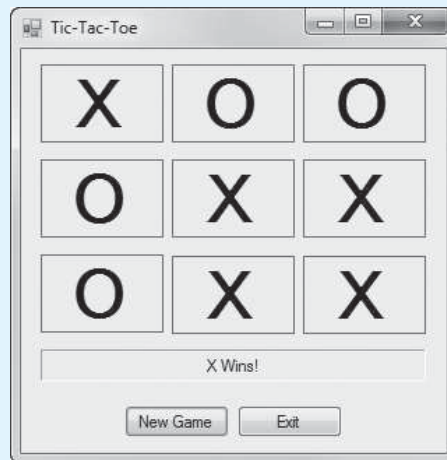
- The average annual change in population during the time period
- The year with the greatest increase in population during the time period
- The year with the least increase in population during the time period

## 8. Tic-Tac-Toe Simulator

Create an application that simulates a game of tic-tac-toe. Figure 7-45 shows an example of the application's form. The form shown in the figure uses eight large `Label` controls to display the Xs and Os.

The application should use a two-dimensional `int` array to simulate the game board in memory. When the user clicks the *New Game* button, the application should step through the array, storing a random number in the range of 0 through 1 in each element. The number 0 represents the letter O, and the number 1 represents the letter X. The form should then be updated to display the game board. The application should display a message indicating whether player X won, player Y won, or the game was a tie.



**Figure 7-45** The *Tic-Tac-Toe* application

### 9. Jagged Array of Exam Scores

Dr. Hunter teaches three sections of her Intro to Computer Science class. She has 12 students in section 1, 8 students in section 2, and 10 students in section 3. In the *Chap07* folder of the Student Sample Programs, you will find the following files:

- Section1.txt—This file contains the final exam scores for each student in section 1. (There are 12 integer scores in the file.)
- Section2.txt—This file contains the final exam scores for each student in section 2. (There are 8 integer scores in the file.)
- Section3.txt—This file contains the final exam scores for each student in section 3. (There are 10 integer scores in the file.)

Create an application that reads these three files and stores their contents in a jagged array. The array's first row should hold the exam scores for the students in section 1, the second row should hold the exam scores for the students in section 2, and the third row should hold the exam scores for the students in section 3.

The application should display each section's exam scores in a separate ListBox control and then use the jagged array to determine the following:

- The average exam score for each individual section
- The average exam score for all the students in the three sections
- The highest exam score among all three sections and the section number in which that score was found
- The lowest exam score among all three sections and the section number in which that score was found

## TOPICS

- |                                     |                           |
|-------------------------------------|---------------------------|
| 8.1 Introduction                    | 8.4 Enumerated Types      |
| 8.2 String and Character Processing | 8.5 The ImageList Control |
| 8.3 Structures                      |                           |

## 8.1

## Introduction

This chapter presents several diverse topics. Now that you have studied the fundamentals of programming using Visual C#, you can use the topics presented in this chapter to perform more advanced operations. First, we discuss various string and character processing techniques that are useful in applications that work extensively with text. Then we discuss structures, which allow you to encapsulate several variables into a single item. After that we discuss enumerated types, which are data types that you can create, consisting of specified values. Last, we discuss the ImageList control, which is a data structure for storing and retrieving images.

## 8.2

## String and Character Processing

**CONCEPT:** Some programming tasks require that you manipulate strings at a detailed level. C# and the .NET Framework provide tools that let you work with individual characters and sets of characters within strings.

Sometimes the data with which a program must work comes in the form of text. Word processors, text messaging programs, e-mail applications, Web browsers, and spell-checkers are just a few examples of programs that work extensively with text. The earlier chapters in this book have demonstrated some simple text processing techniques, such as comparing strings and converting strings to other data types. Sometimes, however, you need to operate on strings at a more detailed level. Some operations require that you access or manipulate the individual characters in a string.

For example, you have probably used programs or Web sites that require you to set up a password that meets certain requirements. Some systems require that passwords have a minimum length and contain at least one uppercase letter, at least one lowercase letter, and at least one numeric digit. These requirements are intended to prevent ordinary words from being used as passwords and thus make the passwords more secure. When a new password is created, the system has to examine each of the password's characters to determine whether it meets the requirements. In the next section you will see an example of an algorithm that performs this very operation. First, however, we discuss the `char` data type and the process of retrieving the individual characters in a string.

## The `char` Data Type

So far in this book, we have used the `string` data type to store text. C# also provides the `char` data type, which is used to store individual characters. A variable of the `char` data type can hold only one character at a time. Here is an example of how you might declare a `char` variable:

```
char letter;
```

This statement declares a `char` variable named `letter`, which can store one character. In C#, **character literals** are enclosed in single quotation marks. Here is an example showing how we would assign a character to the `letter` variable:

```
letter = 'g';
```

This statement assigns the character 'g' to the `letter` variable. Because `char` variables can hold only one character, they are not compatible with strings. For example, you cannot assign a string to a `char` variable, even if the string contains only one character. The following statement, for example, will not compile because it attempts to assign a string literal to a `char` variable.

```
letter = "g"; // ERROR! Cannot assign a string to a char
```

It is important that you do not confuse character literals, which are enclosed in single quotation marks, with string literals, which are enclosed in double quotation marks.

When you need to convert a `char` variable to a string, you can call its `ToString` method. For example, the following statement displays the value of the `letter` variable in a message box:

```
MessageBox.Show(letter.ToString());
```

The following statement shows another example. Assume that `letter` is a `char` variable and `outputLabel` is the name of a `Label` control:

```
outputLabel.Text = letter.ToString();
```

## Retrieving the Individual Characters in a String

C# allows you to access the individual characters in a string using subscript notation. This makes it possible to work with a string as if it were an array of characters. You use subscript 0 to access the first character, subscript 1 to access the second character, and so on. The subscript of the last character is 1 less than the string's length. The following code shows an example.

```
1 // Declare a string and a char.
2 string name = "Jacob";
3 char letter;
4
5 // Get the first character (at position 0).
```

```

6 letter = name[0];
7
8 // Display the character.
9 MessageBox.Show(letter.ToString());

```

In this code, line 2 declares a `string` variable named `name`, initialized with the string "Jacob". Line 3 declares a `char` variable named `letter`. Line 6 gets the character at position 0 in `name` (the first character in the string) and assigns it to the `letter` variable. Line 9 displays the value of the `letter` variable in a message box. If this code were executed, a message box would appear showing the character J.



**NOTE:** As with arrays, an exception occurs if you attempt to use an invalid subscript with a string. String subscripts must be at least 0, and they must be less than the length of the string.

The following code sample shows how a loop can be used to step through the characters in a string. Notice that in the `for` loop, the `index` variable has a starting value of 0 and is incremented after each iteration, and the loop iterates as long as `index` is less than `name.Length`. If this code were executed, a series of message boxes would appear displaying the characters J, a, c, o, and b.

```

1 // Declare a string and a char.
2 string name = "Jacob";
3 char letter;
4
5 // Display the characters in the string.
6 for (int index = 0; index < name.Length; index++)
7 {
8     letter = name[index];
9     MessageBox.Show(letter.ToString());
10 }

```

Keep in mind that subscripts provide read-only access to the characters in a string. You cannot use a subscript to change the value of a character. For example, the following code will not compile because the second statement attempts to use a subscript expression to change the value of the first character in the `name` variable:

```

string name = "Jill";
name[0] = 'B'; // ERROR! This will not work!

```

You can also use the `foreach` loop to retrieve the individual characters in a string. The following code shows an example. If this code were executed, a series of message boxes would appear displaying the characters J, a, c, o, and b.

```

1 // Declare a string and a char.
2 string name = "Jacob";
3 char letter;
4
5 // Display the characters in the string.
6 foreach (char letter in name)
7 {
8     MessageBox.Show(letter.ToString());
9 }
10 }

```

## Character Testing and Conversion Methods

The `char` data type provides several methods for testing the value of a character. Some of the methods are listed in Table 8-1. Note that each of the methods listed in the table returns a Boolean value of `true` or `false`.

**Table 8-1** Some of the Character Testing Methods

Method	Description
<code>char.IsDigit(ch)</code>	<p>The argument <i>ch</i> is a character. The method returns <code>true</code> if <i>ch</i> is a digit (0 through 9) or <code>false</code> otherwise.</p> <p><i>Example:</i></p> <pre>string str = "12345"; if (char.IsDigit(str[0])) {     MessageBox.Show("Character 0 is " +                     "a digit."); }</pre>
<code>char.IsDigit(str, index)</code>	<p>The argument <i>str</i> is a string, and <i>index</i> is the position of a character within <i>str</i>. The method returns <code>true</code> if the specified character is a digit (0 through 9) or <code>false</code> otherwise.</p> <p><i>Example:</i></p> <pre>string str = "12345"; if (char.IsDigit(str, 0)) {     MessageBox.Show("Character 0 is " +                     "a digit."); }</pre>
<code>char.IsLetter(ch)</code>	<p>The argument <i>ch</i> is a character. The method returns <code>true</code> if <i>ch</i> is an alphabetic letter or <code>false</code> otherwise.</p> <p><i>Example:</i></p> <pre>string str = "Hello World"; if (char.IsLetter(str[0])) {     MessageBox.Show("Character 0 is " +                     "a letter."); }</pre>
<code>char.IsLetter(str, index)</code>	<p>The argument <i>str</i> is a string, and <i>index</i> is the position of a character within <i>str</i>. The method returns <code>true</code> if the specified character is an alphabetic letter or <code>false</code> otherwise.</p> <p><i>Example:</i></p> <pre>string str = "Hello World"; if (char.IsLetter(str, 0)) {     MessageBox.Show("Character 0 is " +                     "a letter."); }</pre>
<code>char.IsLetterOrDigit(ch)</code>	<p>The argument <i>ch</i> is a character. The method returns <code>true</code> if <i>ch</i> is either an alphabetic letter or a numeric digit. Otherwise, the method returns <code>false</code>.</p> <p><i>Example:</i></p> <pre>string str = "Hello World"; if (char.IsLetterOrDigit(str[0])) {     MessageBox.Show("Character 0 is " +                     "either a letter " +                     "or a digit."); }</pre>

(continued)

**Table 8-1** Some of the Character Testing Methods (*continued*)

Method	Description
<code>char.IsLetterOrDigit(str, index)</code>	<p>The argument <i>str</i> is a string, and <i>index</i> is the position of a character within <i>str</i>. The method returns <code>true</code> if the specified character is either an alphabetic letter or a numeric digit. Otherwise, the method returns <code>false</code>.</p> <p><i>Example:</i></p> <pre>string str = "12345"; if (char.IsLetterOrDigit(str, 0)) {     MessageBox.Show("Character 0 is " +                     "either a letter " +                     "or a digit."); }</pre>
<code>char.IsLower(ch)</code>	<p>The argument <i>ch</i> is a character. The method returns <code>true</code> if <i>ch</i> is a lowercase letter or <code>false</code> otherwise.</p> <p><i>Example:</i></p> <pre>string str = "hello world"; if (char.IsLower(str[0])) {     MessageBox.Show("Character 0 is " +                     "lowercase."); }</pre>
<code>char.IsLower(str, index)</code>	<p>The argument <i>str</i> is a string, and <i>index</i> is the position of a character within <i>str</i>. The method returns <code>true</code> if the specified character is a lowercase letter or <code>false</code> otherwise.</p> <p><i>Example:</i></p> <pre>string str = "hello world"; if (char.IsLower(str, 0)) {     MessageBox.Show("Character 0 is " +                     "lowercase."); }</pre>
<code>char.IsPunctuation(ch)</code>	<p>The argument <i>ch</i> is a character. The method returns <code>true</code> if <i>ch</i> is categorized as a punctuation mark or <code>false</code> otherwise.</p> <p><i>Example:</i></p> <pre>string str = "Hello!"; if (char.IsPunctuation(str[5])) {     MessageBox.Show("Character 5 is a " +                     "punctuation mark."); }</pre>
<code>char.IsPunctuation(str, index)</code>	<p>The argument <i>str</i> is a string, and <i>index</i> is the position of a character within <i>str</i>. The method returns <code>true</code> if the specified character is categorized as a punctuation mark or <code>false</code> otherwise.</p> <p><i>Example:</i></p> <pre>string str = "Hello!"; if (char.IsPunctuation(str, 5)) {     MessageBox.Show("Character 5 is a " +                     "punctuation mark."); }</pre>

*(continued)*

**Table 8-1** Some of the Character Testing Methods (*continued*)

Method	Description
<code>char.IsUpper(ch)</code>	<p>The argument <i>ch</i> is a character. The method returns <code>true</code> if <i>ch</i> is an uppercase letter or <code>false</code> otherwise.</p> <p><i>Example:</i></p> <pre>string str = "Hello World"; if (char.IsUpper(str[0])) {     MessageBox.Show("Character 0 is " +                     "uppercase."); }</pre>
<code>char.IsUpper(str, index)</code>	<p>The argument <i>str</i> is a string, and <i>index</i> is the position of a character within <i>str</i>. The method returns <code>true</code> if the specified character is an uppercase letter or <code>false</code> otherwise.</p> <p><i>Example:</i></p> <pre>string str = "Hello World"; if (char.IsUpper(str, 0)) {     MessageBox.Show("Character 0 is " +                     "uppercase."); }</pre>
<code>char.IsWhiteSpace(ch)</code>	<p>The argument <i>ch</i> is a character. The method returns <code>true</code> if <i>ch</i> is a white-space character or <code>false</code> otherwise. (White-space characters are the space, tab, linefeed, carriage-return, formfeed, vertical-tab, and newline characters.)</p> <p><i>Example:</i></p> <pre>string str = " "; if (char.IsWhiteSpace(str[0])) {     MessageBox.Show("Character 0 is " +                     "whitespace."); }</pre>
<code>char.IsWhiteSpace(str, index)</code>	<p>The argument <i>str</i> is a string, and <i>index</i> is the position of a character within <i>str</i>. The method returns <code>true</code> if the specified character is a white-space character or <code>false</code> otherwise. (White-space characters are the space, tab, linefeed, carriage-return, formfeed, vertical-tab, and newline characters.)</p> <p><i>Example:</i></p> <pre>string str = " "; if (char.IsWhiteSpace(str, 0)) {     MessageBox.Show("Character 0 is " +                     "whitespace."); }</pre>

In Tutorial 8-1 you use several of the character testing methods in an application that validates passwords.



**Tutorial 8-1:**  
Completing the  
*Password Validation*  
Application



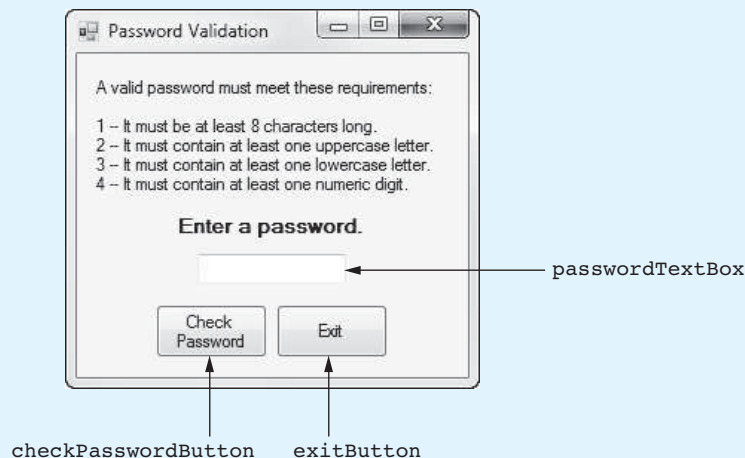
## Tutorial 8-1: Completing the *Password Validation* Application

Many password-protected systems allow users to set up their own passwords. When a user creates a password, the system examines the password to determine whether it meets the minimum requirements. If it does not, the system rejects the password and requires the user to create another, more secure, password.

In this tutorial you complete the *Password Validation* application. The application's form, which has already been created for you, is shown in Figure 8-1. When the application is complete, the user will enter a password and then click the *Check Password* button. The application will check the password to make sure it meets the following requirements:

- The password must be at least eight characters long.
- The password must contain at least one uppercase character.
- The password must contain at least one lowercase character.
- The password must contain at least one numeric digit.

**Figure 8-1** The *Password Validation* application's form



**Step 1:** Start Visual Studio (or Visual Studio Express). Open the project named *Password Validation* in the *Chap08* folder of the Student Sample Programs.

**Step 2:** Open the Form1 form's code in the code editor. Type the comments and code for the `NumberUpperCase` method, shown in lines 20–37 of Program 8-1. The purpose of the `NumberUpperCase` method is to accept a string as an argument and return the number of uppercase letters contained in the string.

**Step 3:** Type the comments and code for the `NumberLowerCase` method, shown in lines 39–56 of Program 8-1. The purpose of the `NumberLowerCase` method is to accept a string as an argument and return the number of lowercase letters contained in the string.

**Step 4:** Type the comments and code for the `NumberDigits` method, shown in lines 58–75 of Program 8-1. The purpose of the `NumberDigits` method is to accept a string as an argument and return the number of numeric digits contained in the string.



**Step 5:** Next you create the Click event handlers for the Button controls. Switch back to the *Designer* and double-click the `checkPasswordButton` control. This opens the code editor, and you will see an empty event handler named `checkPasswordButton_Click`. Complete the event handler by typing the code shown in lines 79–96 in Program 8-1. Let’s review this code:

**Lines 79–82:** The statement in line 79 declares a constant for the minimum password length. Line 82 declares the `password` variable and initializes it with the value entered by the user.

**Line 85:** The `if-else` statement that begins in line 85 evaluates a compound Boolean expression. In plain English, the statement should be interpreted like this:

*If the password’s length is at least 8 and  
the number of uppercase letters in the password is at least 1 and  
the number of lowercase letters in the password is at least 1 and  
the number of numeric digits in the password is at least 1,  
Then the password is valid.*

*Else*

*The password does not meet the requirements.*

**Step 6:** Switch your view back to the *Designer* and double-click the `exitButton` control. In the code editor you will see an empty event handler named `exitButton_Click`. Complete the event handler by typing the code shown in lines 101–102 in Program 8-1.

**Step 7:** Save the project. Then, press `[F5]` on the keyboard or click the *Start Debugging* button (🐞) on the toolbar to compile and run the application. When the application runs, test various passwords to confirm that the application works properly. When you are finished, click the *Exit* button to exit the application.

---

#### Program 8-1 Completed code for Form1 in the *Password Validation* application

```

1 using System;
2 using System.Collections.Generic;
3 using System.ComponentModel;
4 using System.Data;
5 using System.Drawing;
6 using System.Linq;
7 using System.Text;
8 using System.Threading.Tasks;
9 using System.Windows.Forms;
10
11 namespace Password_Validation
12 {
13     public partial class Form1 : Form
14     {
15         public Form1()
16         {
17             InitializeComponent();
18         }
19
20         // The NumberUpperCase method accepts a string argument
21         // and returns the number of uppercase letters it contains.
22         private int NumberUpperCase(string str)
23         {
24             int upperCase = 0; // The number of uppercase letters

```

```

25
26         // Count the uppercase characters in str.
27         foreach (char ch in str)
28         {
29             if (char.IsUpper(ch))
30             {
31                 upperCase++;
32             }
33         }
34
35         // Return the number of uppercase characters.
36         return upperCase;
37     }
38
39     // The NumberLowerCase method accepts a string argument
40     // and returns the number of lowercase letters it contains.
41     private int NumberLowerCase(string str)
42     {
43         int lowerCase = 0; // The number of lowercase letters
44
45         // Count the lowercase characters in str.
46         foreach (char ch in str)
47         {
48             if (char.IsLower(ch))
49             {
50                 lowerCase++;
51             }
52         }
53
54         // Return the number of lowercase characters.
55         return lowerCase;
56     }
57
58     // The NumberDigits method accepts a string argument
59     // and returns the number of numeric digits it contains.
60     private int NumberDigits(string str)
61     {
62         int digits = 0; // The number of digits
63
64         // Count the digits in str.
65         foreach (char ch in str)
66         {
67             if (char.IsDigit(ch))
68             {
69                 digits++;
70             }
71         }
72
73         // Return the number of digits.
74         return digits;
75     }
76
77     private void checkPasswordButton_Click(object sender, EventArgs e)
78     {
79         const int MIN_LENGTH = 8; // Password's minimum length
80
81         // Get the password from the TextBox.
82         string password = passwordTextBox.Text;
83

```

```

84         // Validate the password.
85         if (password.Length >= MIN_LENGTH &&
86             NumberUpperCase(password) >= 1 &&
87             NumberLowerCase(password) >= 1 &&
88             NumberDigits(password) >= 1)
89         {
90             MessageBox.Show("The password is valid.");
91         }
92         else
93         {
94             MessageBox.Show("The password does not meet " +
95                             "the requirements.");
96         }
97     }
98
99     private void exitButton_Click(object sender, EventArgs e)
100    {
101        // Close the form.
102        this.Close();
103    }
104 }
105 }

```

## Character Case Conversion

The `char` data type also provides the `ToLower` and `ToUpper` methods listed in Table 8-2 for converting the case of a character. Each method accepts a `char` argument and returns a `char` value.

**Table 8-2** Character Case Conversion Methods

Method	Description
<code>char.ToLower(ch)</code>	The argument <i>ch</i> is a character. The method returns the lowercase equivalent of <i>ch</i> .
<code>char.ToUpper(ch)</code>	The argument <i>ch</i> is a character. The method returns the uppercase equivalent of <i>ch</i> .

If the `ToLower` method's argument is an uppercase character, the method returns the lowercase equivalent. For example, look at the following code. The statement in line 2 assigns the character 'a' to the `letter` variable.

```

1 string str = "ABC";
2 char letter = char.ToLower(str[0]);

```

If the argument is already lowercase, the `ToLower` method returns it unchanged.

If the `ToUpper` method's argument is a lowercase character, the method returns the uppercase equivalent. For example, look at the following code. The statement in line 2 assigns the character 'A' to the `letter` variable.

```

1 string str = "abc";
2 char letter = char.ToUpper(str[0]);

```

If the argument is already uppercase, the `ToUpper` method returns it unchanged.

## Searching for Substrings

Some tasks require you to search for a specific string of characters within a string. A string within a string is called a **substring**. Objects of the `string` data type have several methods that allow you to search for substrings. Table 8-3 summarizes the **Contains**, **StartsWith**, and **EndsWith** methods. Each of the methods in Table 8-3 returns a Boolean value indicating whether the substring was found.

**Table 8-3** Some of the Substring-Searching Methods

Method	Description
<code>stringVar.Contains(substring)</code>	<p><code>stringVar</code> is the name of a <code>string</code> variable or is a string expression. The argument <code>substring</code> is also a string. The method returns <code>true</code> if <code>stringVar</code> contains the string <code>substring</code> or <code>false</code> otherwise.</p> <p><i>Example:</i></p> <pre>// The following code displays // "ice was found." string str = "chocolate ice cream"; if (str.Contains("ice")) {     MessageBox.Show("ice was found."); }</pre>
<code>stringVar.Contains(ch)</code>	<p><code>stringVar</code> is the name of a <code>string</code> variable or is a string expression. The argument <code>ch</code> is a character. The method returns <code>true</code> if <code>stringVar</code> contains the character <code>ch</code> or <code>false</code> otherwise.</p> <p><i>Example:</i></p> <pre>// The following code displays // "b was found." string str = "abcd"; if (str.Contains('b')) {     MessageBox.Show("b was found."); }</pre>
<code>stringVar.StartsWith(substring)</code>	<p><code>stringVar</code> is the name of a <code>string</code> variable or is a string expression. The argument <code>substring</code> is also a string. The method returns <code>true</code> if <code>stringVar</code> starts with the string <code>substring</code> or <code>false</code> otherwise.</p> <p><i>Example:</i></p> <pre>// The following code displays "The string // starts with choc." string str = "chocolate ice cream"; if (str.StartsWith("choc")) {     MessageBox.Show("The string starts " +                     "with choc."); }</pre>

(continued)

**Table 8-3** Some of the Substring-Searching Methods (*continued*)

Method	Description
<code>stringVar.EndsWith(substring)</code>	<p><code>stringVar</code> is the name of a string variable or is a string expression. The argument <code>substring</code> is also a string. The method returns <code>true</code> if <code>stringVar</code> ends with the string <code>substring</code> or <code>false</code> otherwise.</p> <p><i>Example:</i></p> <pre>// The following code displays "The string // ends with cream." string str = "chocolate ice cream"; if (str.EndsWith("cream")) {     MessageBox.Show("The string ends " +                     "with cream."); }</pre>

The methods shown in Table 8-3 let you know whether a specified substring is found within a string. Sometimes you also want to know the position of the substring. When that is the case, you can use one of the **IndexOf** or **LastIndexOf** methods shown in Table 8-4. Note that each method in Table 8-4 returns an `int`.

**Table 8-4** Methods for Getting a Character or Substring's Position

Method	Description
<code>stringVar.IndexOf(substring)</code>	<p><code>stringVar</code> is the name of a string variable or is a string expression. The argument <code>substring</code> is also a string. If <code>substring</code> is found in <code>stringVar</code>, the method returns the integer position of <code>substring</code>'s first occurrence. If <code>substring</code> is not found in <code>stringVar</code>, the method returns <code>-1</code>.</p> <p><i>Example:</i></p> <pre>// The following code displays "10" string str = "chocolate ice cream"; int position = str.IndexOf("ice"); if (position != -1) {     MessageBox.Show(position.ToString()); } else {     MessageBox.Show("ice was not found."); }</pre>
<code>stringVar.IndexOf(substring, start)</code>	<p><code>stringVar</code> is the name of a string variable or is a string expression. The argument <code>substring</code> is a string, and the argument <code>start</code> is an integer. The method searches <code>stringVar</code> for <code>substring</code>, starting at the position specified by <code>start</code> and going to the end of <code>stringVar</code>. If <code>substring</code> is found in this portion of <code>stringVar</code>, the method returns the integer position of its first occurrence. If <code>substring</code> is not found, the method returns <code>-1</code>.</p>

*(continued)*

**Table 8-4** Methods for Getting a Character or Substring's Position (*continued*)

Method	Description
<pre>stringVar.IndexOf(substring, start, count)</pre>	<p><i>Example:</i></p> <pre>// The following code displays "2" string str = "cocoa beans"; int position = str.IndexOf("co", 2); if (position != -1) {     MessageBox.Show(position.ToString()); } else {     MessageBox.Show("co was not found."); }</pre> <p><i>stringVar</i> is the name of a string variable or is a string expression. The argument <i>substring</i> is a string, the argument <i>start</i> is an integer, and the argument <i>count</i> is also an integer. The method searches <i>stringVar</i> for <i>substring</i>, starting at the position specified by <i>start</i> and continuing for <i>count</i> characters. If <i>substring</i> is found in this portion of <i>stringVar</i>, the method returns the integer position of its first occurrence. If <i>substring</i> is not found, the method returns -1.</p>
<pre>stringVar.IndexOf(ch)</pre>	<p><i>Example:</i></p> <pre>// The following code displays "6" string str = "xx oo xx oo xx"; int position = str.IndexOf("xx", 3, 8); if (position != -1) {     MessageBox.Show(position.ToString()); } else {     MessageBox.Show("xx was not found."); }</pre> <p><i>stringVar</i> is the name of a string variable or is a string expression. The argument <i>ch</i> is a character. If <i>ch</i> is found in <i>stringVar</i>, the method returns the integer position of <i>ch</i>'s first occurrence. If <i>ch</i> is not found in <i>stringVar</i>, the method returns -1.</p>
<pre>stringVar.IndexOf(ch)</pre>	<p><i>Example:</i></p> <pre>// The following code displays "2" string str = "chocolate ice cream"; int position = str.IndexOf('o'); if (position != -1) {     MessageBox.Show(position.ToString()); } else {     MessageBox.Show("o was not found."); }</pre>

*(continued)*

**Table 8-4** Methods for Getting a Character or Substring's Position (*continued*)

Method	Description
<code>stringVar.IndexOf(ch, start)</code>	<p><code>stringVar</code> is the name of a string variable or is a string expression. The argument <code>ch</code> is a character, and the argument <code>start</code> is an integer. The method searches <code>stringVar</code> for <code>ch</code>, starting at the position specified by <code>start</code> and going to the end of <code>stringVar</code>. If <code>ch</code> is found in this portion of <code>stringVar</code>, the method returns the integer position of its first occurrence. If <code>ch</code> is not found, the method returns <code>-1</code>.</p> <p><i>Example:</i></p> <pre>// The following code displays "4" string str = "chocolate ice cream"; int position = str.IndexOf('o', 3); if (position != -1) {     MessageBox.Show(position.ToString()); } else {     MessageBox.Show("o was not found."); }</pre>
<code>stringVar.IndexOf(ch, start, count)</code>	<p><code>stringVar</code> is the name of a string variable or is a string expression. The argument <code>ch</code> is a character, the argument <code>start</code> is an integer, and the argument <code>count</code> is also an integer. The method searches <code>stringVar</code> for <code>ch</code>, starting at the position specified by <code>start</code> and continuing for <code>count</code> characters. If <code>ch</code> is found in this portion of <code>stringVar</code>, the method returns the integer position of its first occurrence. If <code>substring</code> is not found, the method returns <code>-1</code>.</p> <p><i>Example:</i></p> <pre>// The following code displays "12" string str = "chocolate ice cream"; int position = str.IndexOf('e', 10, 4); if (position != -1) {     MessageBox.Show(position.ToString()); } else {     MessageBox.Show("e was not found."); }</pre>
<code>stringVar.LastIndexOf(substring)</code>	<p><code>stringVar</code> is the name of a string variable or is a string expression. The argument <code>substring</code> is also a string. If <code>substring</code> is found in <code>stringVar</code>, the method returns the integer position of <code>substring</code>'s last occurrence. If <code>substring</code> is not found in <code>stringVar</code>, the method returns <code>-1</code>.</p>

*(continued)*

**Table 8-4** Methods for Getting a Character or Substring's Position (*continued*)

Method	Description
<pre><i>stringVar</i>.LastIndexOf(<i>substring</i>,                        <i>start</i>)</pre>	<p><i>Example:</i></p> <pre>// The following code displays "11". string str = "blue green blue"; int position = str.LastIndexOf("blue"); if (position != -1) {     MessageBox.Show(position.ToString()); } else {     MessageBox.Show("blue was not found."); }</pre> <p><i>stringVar</i> is the name of a string variable or is a string expression. The argument <i>substring</i> is a string, and the argument <i>start</i> is an integer. The method searches <i>stringVar</i> for <i>substring</i>, starting at the position specified by <i>start</i> and proceeding backward toward the beginning of <i>stringVar</i>. If <i>substring</i> is found in this portion of <i>stringVar</i>, the method returns its integer position. If <i>substring</i> is not found, the method returns -1.</p>
<pre><i>stringVar</i>.LastIndexOf(<i>substring</i>,                        <i>start</i>, <i>count</i>)</pre>	<p><i>Example:</i></p> <pre>// The following code displays "6". string str = "xx oo xx oo xx"; int position = str.LastIndexOf("xx", 10); if (position != -1) {     MessageBox.Show(position.ToString()); } else {     MessageBox.Show("xx was not found."); }</pre> <p><i>stringVar</i> is the name of a string variable or is a string expression. The argument <i>substring</i> is a string, the argument <i>start</i> is an integer, and the argument <i>count</i> is also an integer. The method searches <i>stringVar</i> for <i>substring</i>, starting at the position specified by <i>start</i> and proceeding backward toward the beginning of <i>stringVar</i> for <i>count</i> characters. If <i>substring</i> is found in this portion of <i>stringVar</i>, the method returns its integer position. If <i>substring</i> is not found, the method returns -1.</p>

*(continued)*



**Table 8-4** Methods for Getting a Character or Substring's Position (*continued*)

Method	Description
	<p><i>Example:</i></p> <pre>// The following code displays "6". string str = "oo xx oo xx oo"; int position = str.LastIndexOf("oo", 10, 8); if (position != -1) {     MessageBox.Show(position.ToString()); } else {     MessageBox.Show("oo was not found."); }</pre>
<code>stringVar.LastIndexOf(ch)</code>	<p><code>stringVar</code> is the name of a string variable or is a string expression. The argument <code>ch</code> is a character. If <code>ch</code> is found in <code>stringVar</code>, the method returns the integer position of <code>ch</code>'s last occurrence. If <code>ch</code> is not found in <code>stringVar</code>, the method returns -1.</p> <p><i>Example:</i></p> <pre>// The following code displays "14". string str = "chocolate ice cream"; int position = str.LastIndexOf('c'); if (position != -1) {     MessageBox.Show(position.ToString()); } else {     MessageBox.Show("c was not found."); }</pre>
<code>stringVar.LastIndexOf(ch, start)</code>	<p><code>stringVar</code> is the name of a string variable or is a string expression. The argument <code>ch</code> is a character, and the argument <code>start</code> is an integer. The method searches <code>stringVar</code> for <code>ch</code>, starting at the position specified by <code>start</code> and proceeding backward toward the beginning of <code>stringVar</code>. If <code>ch</code> is found in this portion of <code>stringVar</code>, the method returns its integer position. If <code>ch</code> is not found, the method returns -1.</p> <p><i>Example:</i></p> <pre>// The following code displays "12". string str = "chocolate ice cream"; int position = str.LastIndexOf('e', 14); if (position != -1) {     MessageBox.Show(position.ToString()); } else {     MessageBox.Show("e was not found."); }</pre>

*(continued)*

**Table 8-4** Methods for Getting a Character or Substring's Position (*continued*)

Method	Description
<code>stringVar.LastIndexOf(ch, start, count)</code>	<p><code>stringVar</code> is the name of a string variable or is a string expression. The argument <code>ch</code> is a character, the argument <code>start</code> is an integer, and the argument <code>count</code> is also an integer. The method searches <code>stringVar</code> for <code>ch</code>, starting at the position specified by <code>start</code> and proceeding backward for <code>count</code> characters. If <code>ch</code> is found in this portion of <code>stringVar</code>, the method returns its integer position. If <code>substring</code> is not found, the method returns <code>-1</code>.</p> <p><i>Example:</i></p> <pre>// The following code displays "12". string str = "chocolate ice cream"; int position = str.LastIndexOf('e', 14, 8); if (position != -1) {     MessageBox.Show(position.ToString()); } else {     MessageBox.Show("e was not found."); }</pre>

Sometimes you need to retrieve a specific set of characters from a string. For example, suppose a string contains a U.S. telephone number, such as "(919)555-1212" and you are interested in getting the area code. You need a way to retrieve the characters in positions 1 through 3. You can use the **Substring method**, as shown in Table 8-5. Note that the Substring method returns a string.

**Table 8-5** The Substring Method

Method	Description
<code>stringVar.Substring(start)</code>	<p><code>stringVar</code> is the name of a string variable or is a string expression. The argument <code>start</code> is an integer that specifies a position in <code>stringVar</code>. The method returns a string containing the characters beginning at <code>start</code>, continuing to the end of <code>stringVar</code>.</p> <p><i>Example:</i></p> <pre>// The following code displays "beans". string str = "cocoa beans"; MessageBox.Show(str.Substring(6));</pre>
<code>stringVar.Substring(start, count)</code>	<p><code>stringVar</code> is the name of a string variable or is a string expression. The argument <code>start</code> is an integer that specifies a position in <code>stringVar</code>, and <code>count</code> is an integer that specifies a number of characters. The method returns a string containing the characters beginning at <code>start</code> and continuing for <code>count</code> characters.</p> <p><i>Example:</i></p> <pre>// The following code displays "cocoa". string str = "cocoa beans"; MessageBox.Show(str.Substring(0, 5));</pre>

## Methods for Modifying a String

Table 8-6 describes several methods that `string` objects have for modifying the contents of a string in the following ways:

- The `Insert` method inserts a string into another string.
- The `Remove` methods remove specified characters from a string.
- The `ToLower` method converts a string to all lowercase characters.
- The `ToUpper` method converts a string to all uppercase characters.
- The `Trim` method removes all leading and trailing spaces from a string. (**Leading spaces** are spaces that appear at the beginning of a string, and **trailing spaces** are spaces that appear at the end of a string.)
- The `TrimStart` method removes all leading spaces from a string.
- The `TrimEnd` method removes all trailing spaces from a string.

It is important to remember that the methods shown in Table 8-6 do not actually modify the calling `string` object. They return a modified copy of the calling `string` object. For example, look at the following code, which demonstrates the `Remove` method:

```
1 string str1 = "sunshine";
2 string str2 = str1.Remove(3);
3 MessageBox.Show(str1);
4 MessageBox.Show(str2);
```

**Table 8-6** Methods for Modifying a String

Method	Description
<code>stringVar.Insert(start, strItem)</code>	<p><code>stringVar</code> is the name of a string variable or is a string expression. The <code>start</code> argument is an integer that specifies a position in <code>stringVar</code>, and the <code>strItem</code> argument is a string that is to be inserted. The method returns a string containing a copy of <code>stringVar</code> with <code>strItem</code> inserted into it beginning at the position specified by <code>start</code>.</p> <p><i>Example:</i></p> <pre>// The following displays "New York City". string str1 = "New City"; string str2 = str1.Insert(4, "York "); MessageBox.Show(str2);</pre>
<code>stringVar.Remove(start)</code>	<p><code>stringVar</code> is the name of a string variable or is a string expression. The <code>start</code> argument is an integer that specifies a position in <code>stringVar</code>. The method returns a string containing a copy of <code>stringVar</code> with all the characters from the position specified by <code>start</code> to the end removed.</p> <p><i>Example:</i></p> <pre>// The following displays "blue". string str1 = "blueberry"; string str2 = str1.Remove(4); MessageBox.Show(str2);</pre>
<code>stringVar.Remove(start, count)</code>	<p><code>stringVar</code> is the name of a string variable or is a string expression. The <code>start</code> argument is an integer that specifies a position in <code>stringVar</code>, and <code>count</code> is an integer that specifies a number of characters. The method returns a string containing a copy of <code>stringVar</code> with <code>count</code> characters removed, beginning at the position specified by <code>start</code>.</p>

(continued)

**Table 8-6** Methods for Modifying a String (*continued*)

Method	Description
	<p><i>Example:</i></p> <pre>// The following displays "jelly doughnuts". string str1 = "jelly filled doughnuts"; string str2 = str1.Remove(6, 7); MessageBox.Show(str2);</pre>
<code>stringVar.ToLower()</code>	<p><code>stringVar</code> is the name of a string variable or is a string expression. The method returns a string containing a copy of <code>stringVar</code> converted to lowercase.</p> <p><i>Example:</i></p> <pre>// The following displays "abc". string str1 = "ABC"; string str2 = str1.ToLower(); MessageBox.Show(str2);</pre>
<code>stringVar.ToUpper()</code>	<p><code>stringVar</code> is the name of a string variable or is a string expression. The method returns a string containing a copy of <code>stringVar</code> converted to uppercase.</p> <p><i>Example:</i></p> <pre>// The following displays "ABC". string str1 = "abc"; string str2 = str1.ToUpper(); MessageBox.Show(str2);</pre>
<code>stringVar.Trim()</code>	<p><code>stringVar</code> is the name of a string variable or is a string expression. The method returns a string containing a copy of <code>stringVar</code> with all leading and trailing spaces removed.</p> <p><i>Example:</i></p> <pre>// The following displays "&gt;Hello&lt;". string str1 = " Hello "; string str2 = str1.Trim(); MessageBox.Show("&gt;" + str2 + "&lt;");</pre>
<code>stringVar.TrimStart()</code>	<p><code>stringVar</code> is the name of a string variable or is a string expression. The method returns a string containing a copy of <code>stringVar</code> with all leading spaces removed.</p> <p><i>Example:</i></p> <pre>// The following displays "&gt;Hello&lt;". string str1 = " Hello"; string str2 = str1.TrimStart(); MessageBox.Show("&gt;" + str2 + "&lt;");</pre>
<code>stringVar.TrimEnd()</code>	<p><code>stringVar</code> is the name of a string variable or is a string expression. The method returns a string containing a copy of <code>stringVar</code> with all trailing spaces removed.</p> <p><i>Example:</i></p> <pre>// The following displays "&gt;Hello&lt;". string str1 = "Hello "; string str2 = str1.TrimEnd(); MessageBox.Show("&gt;" + str2 + "&lt;");</pre>

Line 1 declares a `string` variable named `str1`, initialized with the string "sunshine". Line 2 calls the `str1.Remove` method, passing 3 as an argument. The method returns a copy of `str1` with all the characters from position 3 to the end of the string removed. (The method returns the string "sun".) The string that is returned is assigned to the `str2` variable. Line 3 displays the `str1` variable, which is "sunshine", and line 4 displays the `str2` variable, which is "sun".

In Tutorials 8-2 and 8-3 you use several of the `string` methods that we have discussed in applications that format and unformat U.S. telephone numbers.



**Tutorial 8-2:**  
Completing the  
*Telephone Format*  
Application



## Tutorial 8-2: Completing the *Telephone Format* Application

Telephone numbers in the United States are commonly formatted to appear in the following manner:

(xxx)xxx-xxxx

In the format, `x` represents a digit. The three digits that appear inside the parentheses are the area code. The three digits following the area code are the prefix, and the four digits after the hyphen are the line number. Here is an example:

(919)555-1212

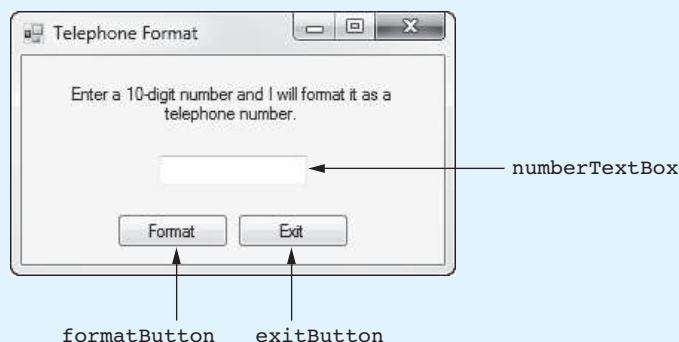
Although the parentheses and the hyphen make the number easier for people to read, those characters are unnecessary for processing by a computer. In a computer system, a telephone number is commonly stored as an unformatted series of digits, as shown here:

9195551212

Programs that work with telephone numbers sometimes need to unformat numbers that have been entered by the user. This means that the parentheses and the hyphen must be removed prior to storing the number in a file or processing it in some other way. In addition, such programs need the ability to format a number so it contains the parentheses and the hyphen before displaying it on the screen or printing it on paper.

In this tutorial you complete the *Telephone Format* application. The application's form, which has already been created for you, is shown in Figure 8-2. When the application is complete, you will be able to enter a string of 10 digits into the `numberTextBox` control and click the *Format* button to see the string of digits formatted as a telephone number.

**Figure 8-2** The *Telephone Format* application's form



**Step 1:** Start Visual Studio (or Visual Studio Express). Open the project named *Telephone Format* in the *Chap08* folder of the Student Sample Programs.

**Step 2:** Open the Form1 form's code in the code editor. Type the comments and code for the `IsValidNumber` method, shown in lines 20–50 of Program 8-2. The method accepts a string as an argument and return `true` if the string is 10 characters long and contains only digits. Otherwise, the method returns `false`. You use this method to make sure that the user has entered a valid string of digits. Let's take a closer look at the code.

**Line 25:** This statement declares the constant `VALID_LENGTH`, initialized with the value 10, to represent the length of a valid string.

**Line 26:** This statement declares a `bool` variable named `valid`, initialized with the value `true`. The `valid` variable is used as a flag to indicate whether the `str` parameter is a valid number.

**Line 29:** This `if` statement determines whether the `str` parameter's length is valid. If so, the program continues at line 32. Otherwise, the program jumps to the `else` clause in line 42, and line 45 assigns `false` to the `valid` variable.

**Line 32:** This `foreach` loop steps through each of the characters in the `str` parameter. If the statement in line 36 determines that a character is *not* a digit, then the statement in line 38 assigns `false` to the `valid` variable.

**Line 49:** This statement returns the value of the `valid` variable.

**Step 3:** Type the comments and code for the `TelephoneFormat` method, shown in lines 52–64 of Program 8-2. The `TelephoneFormat` method accepts a string as an argument, passed by reference, and inserts the parentheses and the hyphen at the proper locations so it appears in the form `(xxx)xxx-xxxx`. Let's take a closer look at the code.

**Line 54:** Notice that the `ref` keyword is used in the declaration of the `str` parameter variable.

**Line 57:** This statement calls the `Insert` method to insert `" ("` at position 0. All the characters in the string are automatically shifted right one space to accommodate the inserted character.

**Line 60:** This statement calls the `Insert` method to insert `")"` at position 4, shifting the characters that previously appeared beginning at position 4 to the right one space.

**Line 63:** This statement calls the `Insert` method to insert `"-"` at position 8, shifting the characters that previously appeared beginning at position 8 to the right one space. After this statement executes, the string referenced by `str` is formatted as `(xxx)xxx-xxxx`.

**Step 4:** Next you create the Click event handlers for the Button controls. Switch back to the *Designer* and double-click the `formatButton` control. This opens the code editor, and you will see an empty event handler named `formatButton_Click`. Complete the event handler by typing the code shown in lines 68–82 in Program 8-2. Let's review this code:

**Line 69:** Notice the expression on the right side of the `=` operator is `numberTextBox.Text.Trim()`. This expression calls the `Trim` method on the `Text` property of the `numberTextBox` control. The method returns a copy of the `numberTextBox` control's `Text` property with all leading and trailing spaces removed. The result is assigned to the `input` variable.

**Line 73:** This `if` statement calls the `IsValidNumber` method, passing the input variable as an argument. If the value of the input variable is a valid number, the method returns `true` and the program continues to line 75. In line 75 the `TelephoneFormat` method is called, passing `input` by reference as an argument, and then line 76 displays the value of the input variable in a message box. If the value of the input variable is not a valid number, the `IsValidNumber` method returns `false`, and the program jumps to the `else` clause in line 78. Then, line 81 displays an error message.

**Step 5:** Switch your view back to the *Designer* and double-click the `exitButton` control. In the code editor you will see an empty event handler named `exitButton_Click`. Complete the event handler by typing the code shown in lines 87–88 in Program 8-2.

**Step 6:** Save the project. Then, press `F5` on the keyboard or click the *Start Debugging* button (🐞) on the toolbar to compile and run the application. When the application runs, test various input values to confirm that the application works properly. For example, if you enter `9195551212`, the application should display `(919)555-1212`, and if you enter `abc5551212`, the application should display `"Invalid input"`. When you are finished, click the *Exit* button to exit the application.

---

#### Program 8-2 Completed code for Form1 in the *Telephone Format* application

```

1 using System;
2 using System.Collections.Generic;
3 using System.ComponentModel;
4 using System.Data;
5 using System.Drawing;
6 using System.Linq;
7 using System.Text;
8 using System.Threading.Tasks;
9 using System.Windows.Forms;
10
11 namespace Telephone_Format
12 {
13     public partial class Form1 : Form
14     {
15         public Form1()
16         {
17             InitializeComponent();
18         }
19
20         // The IsValidNumber method accepts a string and
21         // returns true if it contains 10 digits, or false
22         // otherwise.
23         private bool IsValidNumber(string str)
24         {
25             const int VALID_LENGTH = 10; // Length of a valid string
26             bool valid = true; // Flag to indicate validity
27
28             // Check the string's length.
29             if (str.Length == VALID_LENGTH)
30             {
31                 // Check each character in str.
32                 foreach (char ch in str)
33                 {

```

```

34         // If this character is not a digit, the
35         // string is not valid.
36         if (!char.IsDigit(ch))
37         {
38             valid = false;
39         }
40     }
41 }
42 else
43 {
44     // Incorrect length.
45     valid = false;
46 }
47
48 // Return the status.
49 return valid;
50 }
51
52 // The TelephoneFormat method accepts a string argument
53 // by reference and formats it as a telephone number.
54 private void TelephoneFormat(ref string str)
55 {
56     // First, insert the left paren at position 0.
57     str = str.Insert(0, "(");
58
59     // Next, insert the right paren at position 4.
60     str = str.Insert(4, ")");
61
62     // Next, insert the hyphen at position 8.
63     str = str.Insert(8, "-");
64 }
65
66 private void formatButton_Click(object sender, EventArgs e)
67 {
68     // Get a trimmed copy of the user's input.
69     string input = numberTextBox.Text.Trim();
70
71     // If the input is a valid number, format it
72     // and display it.
73     if (IsValidNumber(input))
74     {
75         TelephoneFormat(ref input);
76         MessageBox.Show(input);
77     }
78     else
79     {
80         // Display an error message.
81         MessageBox.Show("Invalid input");
82     }
83 }
84
85 private void exitButton_Click(object sender, EventArgs e)
86 {
87     // Close the form.
88     this.Close();
89 }
90 }
91 }

```





VideoNote

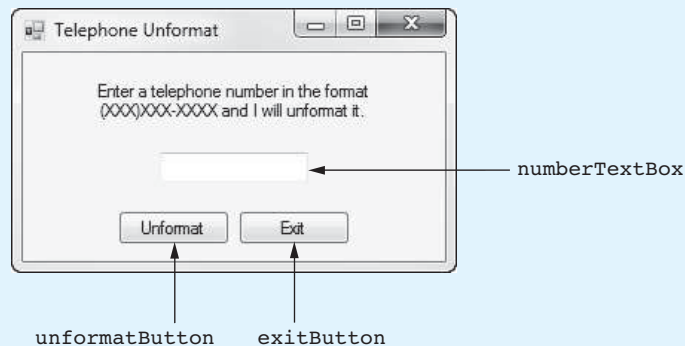
**Tutorial 8-3:**  
Completing the  
*Telephone Unformat*  
Application



## Tutorial 8-3: Completing the *Telephone Unformat* Application

In this tutorial you complete the *Telephone Unformat* application. The application's form, which has already been created for you, is shown in Figure 8-3. When the application is complete, you will be able to enter a telephone number in the format (xxx)xxx-xxxx into the `numberTextBox` control and click the *Unformat* button to see it with the parentheses and the hyphen removed.

**Figure 8-3** The *Telephone Unformat* application's form



**Step 1:** Start Visual Studio (or Visual Studio Express). Open the project named *Telephone Unformat* in the *Chap08* folder of the Student Sample Programs.

**Step 2:** Open the `Form1` form's code in the code editor. Type the comments and code for the `IsValidFormat` method, shown in lines 20–44 of Program 8-3. The method accepts a string as an argument and returns `true` if the string is formatted as (xxx)xxx-xxxx. Otherwise, the method returns `false`. You use this method to make sure that the user has entered a properly formatted telephone number. Let's take a closer look at the code:

**Line 28:** This statement declares the constant `VALID_LENGTH`, initialized with the value 13, to represent the length of a properly formatted telephone number.

**Line 29:** This statement declares a `bool` variable named `valid`, initialized with the value `true`. The `valid` variable is used as a flag to indicate whether the `str` parameter is properly formatted.

**Lines 32–33:** The `if-else` statement that begins in these lines determines whether the `str` parameter is properly formatted. In plain English, the statement should be interpreted like this:

*If the string's length is 13 and the character at position 0 is "(" and the character at position 4 is ")" and the character at position 8 is "-" Then*

*Set valid to true.*

*Else*

*Set valid to false.*

After the `if-else` statement executes, the `valid` variable will be set to either `true` or `false`, indicating whether `str` is properly formatted. The statement in line 39 returns the value of the `valid` variable.

**Line 43:** This statement returns the value of the `valid` variable.

**Step 3:** Type the comments and code for the `unformat` method, shown in lines 46–65 of Program 8-3. The `unformat` method accepts a string as an argument, passed

by reference. The method assumes that the string is formatted as (xxx)xxx-xxxx. When the method is finished, the parentheses and the hyphen will be removed from the string. Let's take a closer look at the code:

**Line 54:** This statement deletes the character at position 0, which is the "(" character. All the remaining characters are automatically shifted left by one position to occupy the space left by the deleted character.

**Line 59:** This statement deletes the character at position 3, which is the ")" character. The characters that previously appeared beginning at position 4 are automatically shifted left to occupy the space left by the deleted character.

**Line 64:** This statement deletes character at position 6, which is the hyphen. The characters previously appearing to the right of the hyphen are automatically moved left by one position. After this statement executes, the string referenced by `str` will be unformatted, appearing simply as a string of digits.


**Step 4:** Next you create the Click event handlers for the Button controls. Switch back to the *Designer* and double-click the `unformatButton` control. This opens the code editor, and you will see an empty event handler named `unformatButton_Click`. Complete the event handler by typing the code shown in lines 69–83 in Program 8-3. Let's review this code:

**Line 70:** Notice the expression on the right side of the = operator is `numberTextBox.Text.Trim()`. This expression calls the `Trim` method on the `Text` property of the `numberTextBox` control. The method returns a copy of the `numberTextBox` control's `Text` property with all leading and trailing spaces removed. The result is assigned to the `input` variable.

**Line 74:** This `if` statement calls the `IsValidFormat` method, passing the `input` variable as an argument. If the value of the `input` variable is properly formatted, the method returns `true`, and the program continues to line 76. In line 76 the `Unformat` method is called, passing `input` by reference as an argument, and then line 77 displays the value of the `input` variable in a message box.

If the value of the `input` variable is not properly formatted, the `IsValidFormat` method returns `false`, and the program jumps to the `else` clause in line 79. Then, line 82 displays an error message.

**Step 5:** Switch your view back to the *Designer* and double-click the `exitButton` control. In the code editor you will see an empty event handler named `exitButton_Click`. Complete the event handler by typing the code shown in lines 88–89 in Program 8-3.

**Step 6:** Save the project. Then, press `[F5]` on the keyboard or click the *Start Debugging* button  on the toolbar to compile and run the application. When the application runs, test various input values to confirm that the application works properly. For example, if you enter (919)555-1212, the application should display 9195551212, and if you enter 919-555-1212, the application should display "Invalid input". When you are finished, click the *Exit* button to exit the application.

### Program 8-3 Completed code for Form1 in the Telephone Unformat application

```

1 using System;
2 using System.Collections.Generic;
3 using System.ComponentModel;
4 using System.Data;
5 using System.Drawing;
6 using System.Linq;

```

```

7 using System.Text;
8 using System.Threading.Tasks;
9 using System.Windows.Forms;
10
11 namespace Telephone_Unformat
12 {
13     public partial class Form1 : Form
14     {
15         public Form1()
16         {
17             InitializeComponent();
18         }
19
20         // The IsValidFormat method accepts a string argument
21         // and determines whether it is properly formatted as
22         // a US telephone number in the following manner:
23         // (XXX)XXX-XXXX
24         // If the argument is properly formatted, the method
25         // returns true, otherwise false.
26         private bool IsValidFormat(string str)
27         {
28             const int VALID_LENGTH = 13; // Length of a valid string
29             bool valid; // Flag to indicate validity
30
31             // Determine whether str is properly formatted.
32             if (str.Length == VALID_LENGTH && str[0] == '(' &&
33                 str[4] == ')' && str[8] == '-')
34             {
35                 valid = true;
36             }
37             else
38             {
39                 valid = false;
40             }
41
42             // Return the value of valid.
43             return valid;
44         }
45
46         // The unformat method accepts a string, by reference,
47         // assumed to contain a telephone number formatted in
48         // this manner: (XXX)XXX-XXXX.
49         // The method unformats the string by removing the
50         // parentheses and the hyphen.
51         private void Unformat(ref string str)
52         {
53             // First, delete the left paren at position 0.
54             str = str.Remove(0, 1);
55
56             // Next, delete the right paren. Because of the
57             // previous deletion it is now located at
58             // position 3.
59             str = str.Remove(3, 1);
60
61             // Next, delete the hyphen. Because of the
62             // previous deletions it is now located at
63             // position 6.
64             str = str.Remove(6, 1);
65         }

```

```
66
67     private void unformatButton_Click(object sender, EventArgs e)
68     {
69         // Get a trimmed copy of the user's input.
70         string input = numberTextBox.Text.Trim();
71
72         // If the input is properly formatted, unformat it
73         // and display it.
74         if (IsValidFormat(input))
75         {
76             Unformat(ref input);
77             MessageBox.Show(input);
78         }
79         else
80         {
81             // Display an error message.
82             MessageBox.Show("Invalid input");
83         }
84     }
85
86     private void exitButton_Click(object sender, EventArgs e)
87     {
88         // Close the form.
89         this.Close();
90     }
91 }
92 }
```

## Tokenizing Strings

Sometimes a string contains a series of words or other items of data separated by spaces or other characters. For example, look at the following string:

```
"peach raspberry strawberry vanilla"
```

This string contains the following four items of data: peach, raspberry, strawberry, and vanilla. In programming terms, items such as these are known as **tokens**. Notice that a space appears between the items. The character that separates tokens is known as a **delimiter**. Here is another example:

```
"17;92;81;12;46;5"
```

This string contains the following tokens: 17, 92, 81, 12, 46, and 5. Notice that a semicolon appears between each item. In this example, the semicolon is used as a delimiter. Some programming problems require you to read a string that contains a list of items and then extract all the tokens from the string for processing. For example, look at the following string that contains a date:

```
"3-22-2014"
```

The tokens in this string are 3, 22, and 2014, and the delimiter is the hyphen character. Perhaps a program needs to extract the month, day, and year from such a string.

The process of breaking a string into tokens is known as **tokenizing**. In C#, `string` objects have a method named `Split` that is used to tokenize the string. When you call a `string` object's `Split` method, the method extracts tokens from the string and returns them as an array of strings. Each element in the array is one of the tokens.

We discuss two ways that you can call the `Split` method. The first way is to pass the value `null` as an argument. When you pass `null` as an argument to the `Split` method,

the method tokenizes the string using white-space characters as delimiters. (White-space characters are the space, tab, linefeed, carriage-return, formfeed, vertical-tab, and newline characters.) The method returns a `string` array, with each element of the array containing one of the tokens. The following code shows an example:

```

1 // Create a String to tokenize.
2 string str = "one two three four";
3
4 // Get the tokens from the string.
5 string[] tokens = str.Split(null);
6
7 // Display each token.
8 foreach (string s in tokens)
9 {
10     MessageBox.Show(s);
11 }

```

Let's take a closer look at the code:

- Line 2 declares a `string` variable named `str`, initialized with the string "one two three four".
- Line 5 declares a `string` array named `tokens`. The `tokens` array is initialized with the array that is returned from the `str.Split(null)` method call. After this statement executes, the `tokens` array will have four elements, containing the strings "one", "two", "three", and "four".
- The `foreach` loop in lines 8–11 displays each of the `tokens` array's elements in message boxes. When the loop executes, four message boxes will be displayed, one after the other, showing the strings "one", "two", "three", and "four".

The second way that we call the `Split` method is to pass a `char` array as an argument. Each element of the `char` array is used as a delimiter. The following code shows an example:

```

1 // Create a String to tokenize.
2 string str = "one;two;three;four";
3
4 // Create an array of delimiters.
5 char[] delim = { ';' };
6
7 // Get the tokens from the string.
8 string[] tokens = str.Split(delim);
9
10 // Display each token.
11 foreach (string s in tokens)
12 {
13     MessageBox.Show(s);
14 }

```

Let's take a closer look at the code:

- Line 2 declares a `string` variable named `str`, initialized with the string "one;two;three;four".
- Line 5 declares a `char` array named `delim`. Notice that the initialization list contains only one character. The `delim` array has one element, containing the ';' character.
- Line 8 declares a `string` array named `tokens`. The `tokens` array is initialized with the array that is returned from the `str.Split(delim)` method call. After this statement executes, the `tokens` array will have four elements, containing the strings "one", "two", "three", and "four".
- The `foreach` loop in lines 11–14 displays each of the `tokens` array's elements in message boxes. When the loop executes, four message boxes will be displayed, one after the other, showing the strings "one", "two", "three", and "four".

Some situations require that you use multiple characters as delimiters in the same string. For example, look at the following e-mail address:

```
joe@gaddisbooks.com
```

This string uses two delimiters: @ (the *at* symbol) and . (the period). To extract the tokens from this string, we must specify both characters as delimiters. Here is an example:

```
1 // Create a String to tokenize.
2 string str = "joe@gaddisbooks.com";
3
4 // Create an array of delimiters.
5 char[] delim = { '@', '.' };
6
7 // Get the tokens from the string.
8 string[] tokens = str.Split(delim);
9
10 // Display each token.
11 foreach (string s in tokens)
12 {
13     MessageBox.Show(s);
14 }
```

Let's take a closer look at the code:

- Line 2 declares a `string` variable named `str`, initialized with the string "joe@gaddisbooks.com".
- Line 5 declares a `char` array named `delim`, initialized with the characters '@' and '.'.
- Line 8 declares a `string` array named `tokens`. The `tokens` array is initialized with the array that is returned from the `str.Split(delim)` method call. After this statement executes, the `tokens` array will have three elements, containing the strings "joe", "gaddisbooks", and "com".
- The `foreach` loop in lines 11–14 displays each of the `tokens` array's elements in message boxes. When the loop executes, four message boxes will be displayed, one after the other, showing the strings "joe", "gaddisbooks", and "com".

### Trimming a String before Tokenizing

When you are tokenizing a string that was entered by the user and you are using characters other than white spaces as delimiters, you probably want to trim the string before tokenizing it. Otherwise, if the user enters leading white-space characters, they will become part of the first token. Likewise, if the user enters trailing white-space characters, they will become part of the last token. For example, look at the following code:

```
1 // Create a string with leading and trailing whitespaces.
2 String str = "  one;two;three  ";
3
4 // Create a char array containing the semicolon.
5 char[] delim = { ';' };
6
7 // Get the tokens from the string.
8 string[] tokens = str.Split(delim);
9
10 // Display each token.
11 foreach (string s in tokens)
12 {
13     MessageBox.Show("'" + s + "'");
14 }
```

This code produces three message boxes, displaying the following output:

```
* one*
*two*
*three *
```

Notice that the first token contains the leading spaces and the last token contains the trailing spaces. To prevent leading and/or trailing white-space characters from being included in the first and last tokens, use the `Trim` method to remove them. Here is the same code, modified to use the `Trim` method:

```
1 // Create a string with leading and trailing white spaces.
2 String str = " one;two;three ";
3
4 // Create a char array containing the semicolon.
5 char[] delim = { ';' };
6
7 // Trim the string.
8 str = str.Trim();
9
10 // Get the tokens from the string.
11 string[] tokens = str.Split(delim);
12
13 // Display each token.
14 foreach (string s in tokens)
15 {
16     MessageBox.Show("*" + s + "*");
17 }
```

This code produces three message boxes, displaying the following output:

```
*one*
*two*
*three*
```

In Tutorial 8-4 you complete an application that reads and tokenizes data from a file that has been exported by Microsoft Excel.



VideoNote

**Tutorial 8-4:**  
Completing the CSV  
Reader  
Application



## Tutorial 8-4: Completing the CSV Reader Application

A professor keeps her students' test scores in a Microsoft Excel spreadsheet. Figure 8-4 shows a set of five test scores for five students. Each column holds a test score, and each row represents the scores for one student.

**Figure 8-4** Microsoft Excel spreadsheet

	A	B	C	D	E	F
1	87	79	91	82	94	
2	72	79	81	74	88	
3	94	92	81	89	96	
4	77	56	67	81	79	
5	79	82	85	81	90	
6						

Suppose the professor wants you to write a C# application that reads the test scores from the Excel spreadsheet and performs some operation with them. Excel, like many commercial

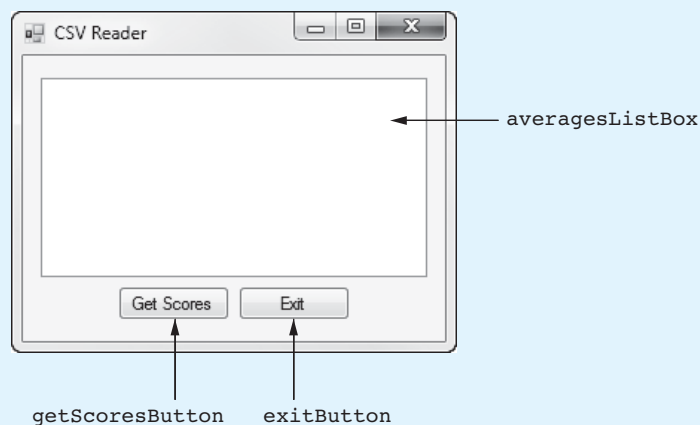
applications, has the ability to export data to a text file. When the data in a spreadsheet is exported, each row is written to a line, and the values of the cells are separated by commas. For example, when the data shown in Figure 8-4 is exported, it will be written to a text file in the following format:

```
87,79,91,82,94
72,79,81,74,88
94,92,81,89,96
77,56,67,81,79
79,82,85,81,90
```

This is called the **comma separated value**, or **CSV**, file format. When you save a spreadsheet in this format, Excel saves it to a file with the `.csv` extension. In a C# application, you can read a line from the file into a `string` variable and then use the `split` method to extract the cell values as tokens.

To learn how this is done, you will complete the *CSV Reader* application. The application's form, which has already been created for you, is shown in Figure 8-5. A file named `Grades.csv`, which contains the test scores shown in Figure 8-4, has also been created for you. When you run the completed application and click the *Get Scores* button, it will read the test scores from the `Grades.csv` file. Each student's average test score will be calculated and displayed in the `averagesListBox` control.

**Figure 8-5** The *CSV Reader* application's form



- Step 1:** Start Visual Studio (or Visual Studio Express). Open the project named *CSV Reader* in the *Chap08* folder of the Student Sample Programs.
- Step 2:** Open the `Form1` form's code in the code editor. Type the `using System.IO;` directive shown in line 10 of Program 8-4. This directive is necessary because we will create a `StreamReader` object to read input from a file.
- Step 3:** Next you create the Click event handlers for the Button controls. Switch back to the *Designer* and double-click the `getScoresButton` control. This opens the code editor, and you will see an empty event handler named `getScoresButton_Click`. Complete the event handler by typing the code shown in lines 23–74 in Program 8-4. Let's review this code:

**Line 23:** This is the beginning of a try-catch statement. The try block appears in lines 25–68, and the catch block appears in lines 72–73. If an exception is



thrown by any statement in the try block, the program will jump to the catch block, and line 73 will display an error message.

**Lines 25–29:** These statements declare the following variables:

- `inputFile`, a `StreamReader` variable that will be used to read file input
- `line`, a `string` variable to hold a line that has been read from the file
- `count`, an `int` that will be used to count the number of students as a loop iterates (Notice that the `count` variable is initialized with the value 0.)
- `total`, an `int` that will hold the total of a student's test scores
- `average`, a `double` that will hold the average of a student's test scores

**Line 32:** This statement creates a `char` array named `delim`. The array has one element containing the character `,`.

**Line 35:** This statement opens the `Grades.csv` file. After the statement executes, the `inputFile` variable references a `StreamReader` object that is associated with the file.

**Line 37:** This is the beginning of a `while` loop that reads the contents of the `Grades.csv` file.

**Line 40:** This statement increments the `count` variable, which keeps count of the number of students. This statement will cause `count` to be set to 1 during the loop's first iteration, 2 during the loop's 2nd iteration, and so forth.

**Line 43:** This statement reads a line from the `Grades.csv` file and assigns it to the `line` variable.

**Line 46:** This statement tokenizes the `line` variable, using the `,` character as a delimiter. After this statement executes, the tokens are stored in the `tokens` array's elements. (The first test score is stored in `tokens[0]`, the second test score is stored in `tokens[1]`, etc.)

**Line 49:** This statement sets the `total` variable to 0. This is necessary because `total` is about to be used as an accumulator in calculating the total of the test scores that are in the `tokens` array.


**Lines 53–56:** This `foreach` loop steps through the elements of the `tokens` array. In line 55 each element is converted to an `int` and then added to the `total` variable. After the loop finishes, the `total` variable will contain the total of the test scores that are in the `tokens` array.

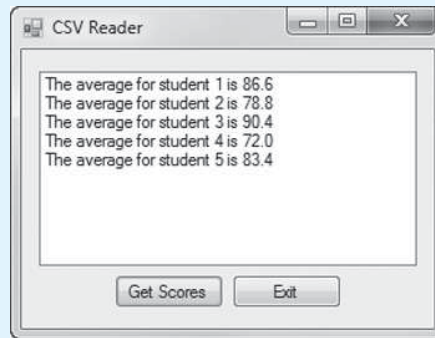
**Line 60:** This statement calculates the average of the test scores and assigns the result to the `average` variable. Note that the `(double)` cast operator is used to prevent integer division.

**Lines 63–64:** This statement displays the average, along with the student number, in the `averageListBox` control.

**Line 68:** This statement closes the `Grades.csv` file.

**Step 4:** Switch your view back to the *Designer* and double-click the `exitButton` control. In the code editor you see an empty event handler named `exitButton_Click`. Complete the event handler by typing the code shown in lines 79–80 in Program 8-4.

**Step 5:** Save the project. Then press `[F5]` on the keyboard or click the *Start Debugging* button  on the toolbar to compile and run the application. When the application runs, click the *Get Scores* button. The student averages should appear as shown in Figure 8-6. When you are finished examining the averages, click the *Exit* button to exit the application.

**Figure 8-6** Test averages displayed**Program 8-4** Completed code for Form1 in the *CSV Reader* application

```

1 using System;
2 using System.Collections.Generic;
3 using System.ComponentModel;
4 using System.Data;
5 using System.Drawing;
6 using System.Linq;
7 using System.Text;
8 using System.Threading.Tasks;
9 using System.Windows.Forms;
10 using System.IO;
11
12 namespace CSV_Reader
13 {
14     public partial class Form1 : Form
15     {
16         public Form1()
17         {
18             InitializeComponent();
19         }
20
21         private void getScoresButton_Click(object sender, EventArgs e)
22         {
23             try
24             {
25                 StreamReader inputFile; // To read the file
26                 string line; // To hold a line from the file
27                 int count = 0; // Student counter
28                 int total; // Accumulator
29                 double average; // Test score average
30
31                 // Create a delimiter array.
32                 char[] delim = { ',' };
33
34                 // Open the CSV file.
35                 inputFile = File.OpenText("Grades.csv");
36
37                 while (!inputFile.EndOfStream)
38                 {
39                     // Increment the student counter.
40                     count++;
41
42                     // Read a line from the file.
43                     line = inputFile.ReadLine();

```

```

44
45         // Get the test scores as tokens.
46         string[] tokens = line.Split(delim);
47
48         // Set the accumulator to 0.
49         total = 0;
50
51         // Calculate the total of the
52         // test score tokens.
53         foreach (string str in tokens)
54         {
55             total += int.Parse(str);
56         }
57
58         // Calculate the average of these
59         // test scores.
60         average = (double)total / tokens.Length;
61
62         // Display the average.
63         averagesListBox.Items.Add("The average for student " +
64             count + " is " + average.ToString("n1"));
65     }
66
67     // Close the file.
68     inputFile.Close();
69 }
70 catch (Exception ex)
71 {
72     // Display an error message.
73     MessageBox.Show(ex.Message);
74 }
75 }
76
77 private void exitButton_Click(object sender, EventArgs e)
78 {
79     // Close the form.
80     this.Close();
81 }
82 }
83 }

```

## Checkpoint

- 8.1 Declare a char variable named `letter` and assign the letter 'A' to the variable.
- 8.2 Write a statement that displays the value of a char variable named `letterGrade` in a message box.
- 8.3 Write a statement that declares a char variable named `lastLetter` and stores the last character of a string named `alphabet` in the variable.
- 8.4 Write a `foreach` loop that displays each character of a string variable named `serialNumber` in a message box.
- 8.5 Write the first line of an `if` statement that calls the `char.IsPunctuation` method and passes the last character of a string variable named `sentence` as an argument.

- 8.6 Write the first line of an `if` statement that calls the `char.IsUpper` method, passing a `string` variable named `sentence` and the index value for the first character of the `sentence` variable as arguments.
- 8.7 Write a statement that calls the `char.ToUpper` method, passes a `char` variable named `lowercase` as an argument, and stores the result in a `char` variable named `uppercase`.
- 8.8 What value does the `char.ToLower` function return if the argument is already lowercase?
- 8.9 Write a statement that calls the `StartsWith` method of a `string` named `dessert`, passes the string `"strawberry"` as an argument, and stores the result in a `Boolean` variable named `found`.
- 8.10 What value is returned by the `IndexOf` and `LastIndexOf` methods if the substring being searched for is not found?
- 8.11 A program has two `string` variables named `str1` and `str2`. Write a statement that trims the leading and trailing whitespace characters from the `str1` variable and assigns the result to the `str2` variable.
- 8.12 A program has two `string` variables named `vegetable` and `veggie`. Write a statement that assigns an all lowercase copy of the `vegetable` variable to the `veggie` variable.
- 8.13 Declare a `char` array named `delimiters` and initialize it with the comma and semicolon characters.
- 8.14 What delimiter is used to separate data in a spreadsheet that has been exported to a text file with the `.csv` file extension?

## 8.3 Structures

**CONCEPT:** C# allows you to group several variables together into a single item known as a **structure**.

So far you have created applications that keep data in individual variables. Sometimes a relationship exists between different items of data. For example, a used-car dealer's inventory system might use the variables shown in the following declaration statements:

```
string make;      // The car's make
int year;        // The car's year model
double mileage;  // The car's mileage
```

All these variables are related because they will hold data about the same car. Their declaration statements, however, do not make it clear that they belong together. To create a relationship between variables, C# gives you the ability to package them together into a single item known as a structure. A **structure** is a data type you can create that contains one or more variables known as fields. The fields can be of different data types.

Before a structure can be used, it must be declared. Here is the general format that we use for declaring a structure:

```
struct StructureName
{
    Field Declarations
}
```

The first line of the structure declaration begins with the keyword `struct`, followed by the structure name. A set of braces appears next, and the braces contain one or more field declarations. Here is an example of a structure declaration:

```
1 struct Automobile
2 {
3     public string make;
4     public int year;
5     public double mileage;
6 }
```

The name of this structure is `Automobile`. In this book we always begin structure names with an uppercase letter. This is not required, but many programmers follow this practice because it helps distinguish structure names from variable names.

Lines 3, 4, and 5 declare three fields. Line 3 declares a `string` field named `make`, line 4 declares an `int` field named `year`, and line 5 declares a `double` field named `mileage`. Notice that each declaration begins with the keyword `public`. The keyword `public` is an access modifier that specifies the field can be directly accessed by statements outside the structure.



**NOTE:** Structures in C# are capable of much more than we discuss in this book. For example, in addition to declaring fields, you can also write methods inside of structures. We use structures for their simplest purpose only: to encapsulate a set of variables into a single item. If you find yourself using a structure for more than this, you should probably use a class instead. We discuss classes in Chapter 9.

In Chapter 2 we discussed the way that C# code is organized in namespaces, classes, and methods. Structure declarations can be written in a variety of places. For example, a structure declaration can appear in these locations:

- Outside the application's namespace
- Inside the application's namespace
- Inside a class
- Inside another structure

In this book we always declare structures inside an application's namespace but not inside of a class. Figure 8-7 shows where, in a form's code, that we typically write structure

**Figure 8-7** Where we typically write structure declarations

```
using System;
using System.Collections.Generic;
using System.ComponentModel;
using System.Data;
using System.Drawing;
using System.Linq;
using System.Text;
using System.Threading.Tasks;
using System.Windows.Forms;

namespace Example
{
    struct Automobile
    {
        public string make;
        public int year;
        public double mileage;
    }

    public partial class Form1 : Form
    {
        public Form1()
        {
            InitializeComponent();
        }
    }
}
```

We will write structure declarations here.

declarations. In the figure we have written the declaration of the `Automobile` structure inside the application's namespace but not inside the `Form1` class.

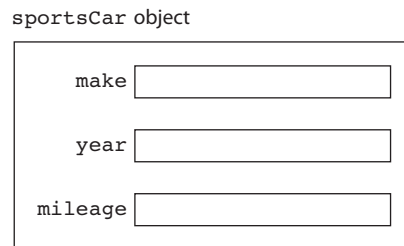
Keep in mind that a structure declaration does not create anything in memory. It simply tells the C# compiler what the structure is made of. Before you can use the structure to store data, you must create an **instance** of the structure in memory. (In programming terms, an *instance* and an *object* are the same thing. When you create an instance of a structure, you are creating an object.)

At the beginning of Chapter 7, we discussed value types and reference types. Structures are value types, so creating an instance of a structure is as simple as declaring a variable. For example, suppose we want to create an instance of the `Automobile` structure and we want the name of the instance to be `sportsCar`. We would write this:

```
Automobile sportsCar;
```

After this statement executes, an instance of the `Automobile` structure exists in memory. The name of the instance is `sportsCar`. As illustrated in Figure 8-8, the `sportsCar` object has three fields: `make`, `year`, and `mileage`.

**Figure 8-8** The `sportsCar` object as an instance of the `Automobile` structure

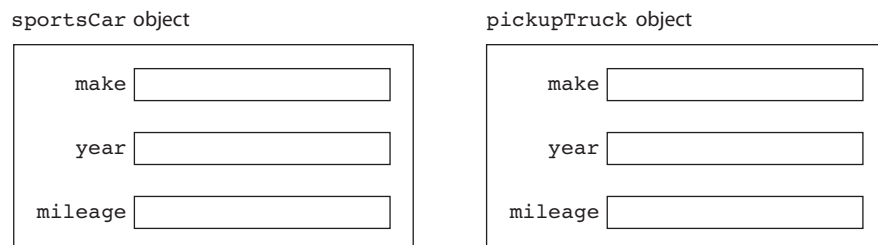


You can create multiple instances of a structure with a declaration statement, as shown here:

```
Automobile sportsCar, pickupTruck;
```

This statement creates two instances of the `Automobile` structure. The objects are named `sportsCar` and `pickupTruck`. As illustrated in Figure 8-9, each object has its own `make`, `year`, and `mileage` fields.

**Figure 8-9** Two instances of the `Automobile` structure



## Using the new Operator to Create Structure Instances

When you create a structure object with a simple declaration statement, as previously shown, the object's fields are uninitialized, and if you attempt to use any of them before assigning them a value, a compiler error occurs. As an alternative, you can use the `new` operator to create an instance of a structure, as shown here:

```
Automobile sportsCar = new Automobile();
```

This is the recommended technique for creating structure instances because the `new` operator not only creates the instance in memory, it also initializes the object's fields with the default value of 0. (If the structure contains any fields that are reference variables, they are initialized with the special value `null`.) Here is an example of creating two instances of the `Automobile` structure using the `new` operator:

```
Automobile sportsCar = new Automobile();
Automobile pickupTruck = new Automobile();
```

## Accessing a Structure's Fields

Once you have created an instance of a structure, you can access its fields using the dot operator (a period). For example, suppose an application contains the `Automobile` structure declaration previously shown and the following code appears in a method:

```
1 Automobile sportsCar = new Automobile();
2 sportsCar.make = "Ford Mustang";
3 sportsCar.year = 1965;
4 sportsCar.mileage = 67500.0;
```

Line 1 creates an instance of the `Automobile` structure in memory. The object's name is `sportsCar`. Line 2 assigns the string "Ford Mustang" to the `sportsCar` object's `make` field. Line 3 assigns the value 1965 to the `sportsCar` object's `year` field. Line 4 assigns the value 67,500.0 to the `sportsCar` object's `mileage` field.

The following code shows another example using the same `sportsCar` object. These statements display the values of the object's fields in message boxes.

```
1 MessageBox.Show(sportsCar.make);
2 MessageBox.Show(sportsCar.year.ToString());
3 MessageBox.Show(sportsCar.mileage.ToString());
```

The following is another example. This statement displays a message such as "1965 Ford Mustang with 67500 miles."

```
MessageBox.Show(sportsCar.year + " " + sportsCar.make +
    " with " + sportsCar.mileage + " miles.");
```

## Assigning One Structure Object to Another

You can use the assignment operator (`=`) to assign one structure object to another. For example, assume that `car1` and `car2` are both instances of the `Automobile` structure. The following statement assigns `car1` to `car2`:

```
car2 = car1;
```

After this statement executes, the `car2` object's fields contain the same values as the `car1` object's fields.

## Passing Structure Objects to Methods

As with other types of objects, you can pass a structure object as an argument to a method. The following code shows a method named `DisplayAuto` that has been written to accept an instance of the `Automobile` structure as an argument:

```
1 private void DisplayAuto(Automobile auto)
2 {
3     MessageBox.Show(auto.year + " " + auto.make +
4         " with " + auto.mileage + " miles.");
5 }
```

Notice in line 1 that the method has a parameter variable named `auto`, and its data type is `Automobile`. When we call this method, we pass an `Automobile` object as an argument, as shown in the following code:

```

1 // Create an instance of the Automobile structure.
2 Automobile sportsCar = new Automobile();
3
4 // Assign values to the object's fields.
5 sportsCar.make = "Chevy Corvette";
6 sportsCar.year = 1970;
7 sportsCar.mileage = 50000.0;
8
9 // Display the object's fields.
10 DisplayAuto(sportsCar);

```

In line 10 the `sportsCar` object is passed as an argument to the `DisplayAuto` method. Inside the `DisplayAuto` method, the `auto` parameter contains a copy of the `sportsCar` object.

Structure objects can be passed by value or by reference. Normally, structure objects are passed by value. The parameter variable contains a copy of the argument, and any changes that are made to the parameter do not affect the original argument. If the receiving method needs to change the contents of the original argument, however, the `ref` or `out` keyword can be used in the parameter declaration. The following code shows a method that uses a reference parameter of the `Automobile` type. Assume that the application's form has `TextBox` controls named `makeTextBox`, `yearTextBox`, and `mileageTextBox`.

```

1 private void GetData(ref Automobile auto)
2 {
3     try
4     {
5         // Get the data from the TextBoxes.
6         auto.make = makeTextBox.Text;
7         auto.year = int.Parse(yearTextBox.Text);
8         auto.mileage = double.Parse(mileageTextBox.Text);
9     }
10    catch (Exception ex)
11    {
12        // Display the exception message.
13        MessageBox.Show(ex.Message);
14    }
15 }

```

Notice that the `auto` parameter is declared with the `ref` keyword. The statements in lines 6–8 get data from the `TextBox` controls and assign that data to the fields of the `auto` parameter. Since `auto` is a `ref` parameter, the values are actually assigned to the object that is passed as an argument to the method.

When we call this method, we pass an `Automobile` object by reference, as shown here:

```

1 // Create an instance of the Automobile structure.
2 Automobile car = new Automobile();
3
4 // Get data for the object.
5 GetData(ref car);

```

After the method executes, the `car` object contains the data that was entered into the `TextBox` controls.



## Comparing Structure Objects

You cannot perform comparison operations directly on structure objects. For example, assume that `sportsCar` and `raceCar` are instances of the `Automobile` structure. The following statement will cause an error.

```
if (sportsCar == raceCar) // Error!
```

In order to compare two structure objects, you must compare the individual fields, as shown in the following code.

```
if (sportsCar.make == raceCar.make &&
    sportsCar.year == raceCar.year &&
    sportsCar.mileage == raceCar.mileage)
{
    MessageBox.Show("The two are equal.");
}
```

## Arrays of Structure Objects

Structure objects can be stored in an array. For example, assume the `Automobile` structure previously shown exists in an application. The following code creates an array of five `Automobile` objects:

```
const int SIZE = 5;
Automobile[] cars = new Automobile[SIZE];
```

When you create a structure array, each element of the array is a structure instance and the fields of each instance are initialized to 0. (If any field is a reference variable, it is initialized to the value `null`.)

Each element of a structure array may be accessed through a subscript. For example, `cars[0]` is the first object in the array, `cars[1]` is the second, and so forth. To access a field of any element, simply place the dot operator and field name after the subscript. For example, the following expression refers to the `mileage` member of `cars[2]`:

```
cars[2].mileage
```

The following `for` loop steps through the `cars` array, displaying the data stored in each element:

```
for (int index = 0; index < cars.Length; index++)
{
    MessageBox.Show(cars[index].year + " " +
        cars[index].make + " with " +
        cars[index].mileage + " miles.");
}
```

You can also use the `foreach` loop to iterate over all of the elements in a structure array, as shown in the following code:

```
foreach (Automobile aCar in cars)
{
    MessageBox.Show(aCar.year + " " +
        aCar.make + " with " +
        aCar.mileage + " miles.");
}
```

## Storing Structure Objects in a List

In Chapter 7 we discussed the `List` class, which is a container for storing a collection of objects. Here is an example of how you would create a `List` that can hold `Automobile` objects:

```
List<Automobile> carList = new List<Automobile>();
```

This statement creates a `List` object, referenced by the `carList` variable. Notice that the word `Automobile` is written inside angled brackets, `<>`, immediately after the word `List`. This specifies that the `List` can hold only objects of the `Automobile` data type.

To add a structure object to a `List`, you use the `Add` method. The following code shows an example:

```

1 // Create a List to hold Automobile objects.
2 List<Automobile> carList = new List<Automobile>();
3
4 // Create an instance of the Automobile structure.
5 Automobile sportsCar = new Automobile();
6
7 // Assign values to the object's fields.
8 sportsCar.make = "Chevy Corvette";
9 sportsCar.year = 1970;
10 sportsCar.mileage = 50000.0;
11
12 // Add the object to the List.
13 carList.Add(sportsCar);

```

The statement in line 2 creates a `List` named `carList` that can hold `Automobile` objects. Line 5 creates an instance of the `Automobile` structure named `sportsCar`, and lines 8–10 assign values to the object's fields. Line 13 adds the object to the `List`.

Keep in mind that structure instances are value type objects, and when you add a value type object to a `List`, the `List` will contain a copy of the object. For example look at the following code:

```

1 // Create a List to hold Automobile objects.
2 List<Automobile> carList = new List<Automobile>();
3
4 // Create an instance of the Automobile structure.
5 Automobile sportsCar = new Automobile();
6
7 // Assign values to the object's fields.
8 sportsCar.make = "Chevy Corvette";
9 sportsCar.year = 1970;
10 sportsCar.mileage = 50000.0;
11
12 // Add the object to the List.
13 carList.Add(sportsCar);
14
15 // Assign new values to the object's fields.
16 sportsCar.make = "Ford Mustang";
17 sportsCar.year = 1965;
18 sportsCar.mileage = 67500.0;
19
20 // Add the object to the List.
21 carList.Add(sportsCar);

```

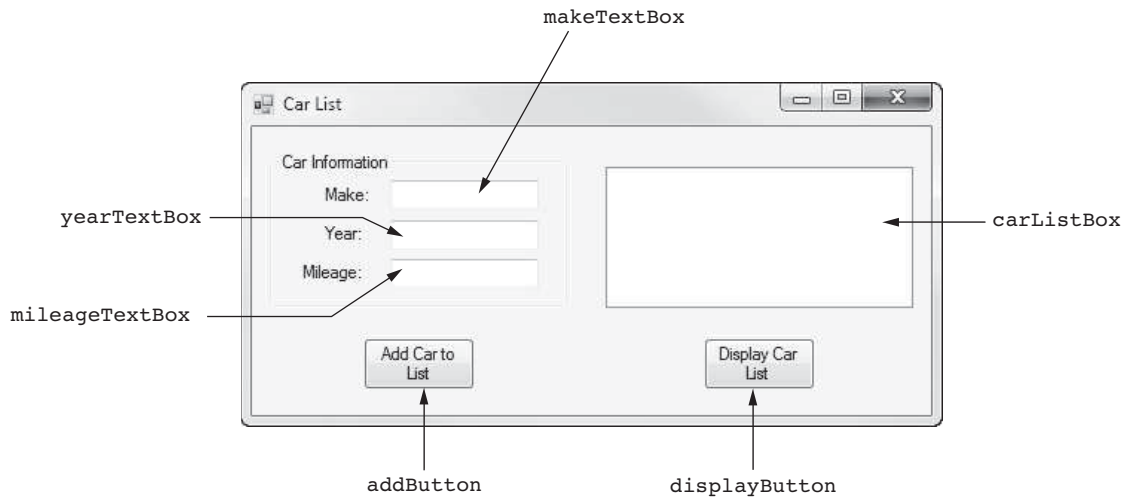
The statement in line 2 creates a `List` named `carList` that can hold `Automobile` objects. Lines 5–10 create an `Automobile` object named `sportsCar` and assign values to the object's fields. Line 13 adds the `sportsCar` object to the `List`. When line 13 executes, a copy of the `sportsCar` object is made and stored in the `List`. (This happens because the `sportsCar` object is a value type object.) At this point, two instances of the `Automobile` structure exist: the `sportsCar` object and the copy of the `sportsCar` object that is in the `List`.

Lines 16–18 assign new values to the `sportsCar` object's fields, and then line 21 adds the `sportsCar` object to the `List` again. Once more, a copy of the `sportsCar` object is made

and added to the `List`. At this point, three instances of the `Automobile` structure exist: the `sportsCar` object and the two objects that are in the `List`.

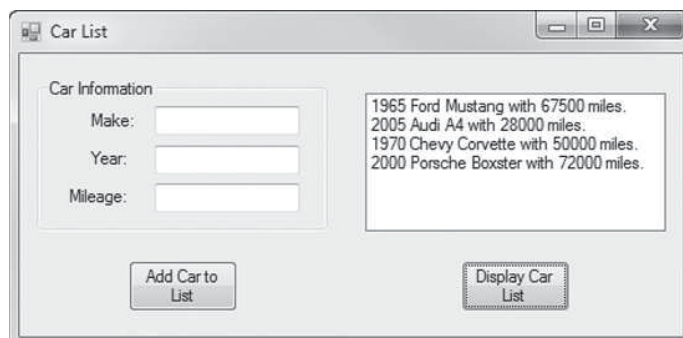
Let's look at a complete program that demonstrates structure objects can be added to a `List`. In the *Chap08* folder of this book's Student Sample Programs, you will find a project named *Car List*. Figure 8-10 shows the application's form.

**Figure 8-10** The *Car List* application's form



When you run the application, you can enter data about a car into the `TextBox` controls. When you click the `addButton` control, that data is assigned to an `Automobile` object and then added to a `List`. You can do this as many times as you wish. When you click the `displayButton` control, the data from each object in the `List` is displayed in the `carListBox` control. Figure 8-11 shows an example of the application's form after four objects have been added to the `List` and the `displayButton` control has been clicked.

**Figure 8-11** The *Car List* application's form with data displayed



Program 8-5 shows the application's `Form1` code. Let's take a closer look:

**Lines 13–18:** The `Automobile` structure is declared in these lines.

**Line 23:** This statement creates a `List` that can hold `Automobile` objects. Notice that the `List` is declared as a field in the `Form1` class. All the methods in the class can access it.

**Lines 33–47:** The `GetData` method appears in these lines. The method accepts an `Automobile` object, by reference, as an argument. The data that has been entered into the form's `TextBox` controls is assigned to the object's fields.

**Lines 49–67:** The `addButton_Click` event handler appears in these lines. Here is a summary of the event handler's code:

- Line 52 creates the `car` object, which is an instance of the `Automobile` structure.
- Line 55 calls the `GetData` method, passing the `car` object, by reference, as an argument. After this statement executes, the `car` object's fields contain the data that was entered into the form's `TextBoxes` by the user.
- Line 58 adds a copy of the `car` object to the `carList`.
- Lines 61–63 clear the contents of the `TextBoxes`.
- Line 66 gives the focus to the `makeTextBox` control.

**Lines 69–87:** The `displayButton_Click` event handler appears in these lines. Here is a summary of the event handler's code:

- Line 72 declares a `string` variable named `output`. This is used to hold a line of output that is displayed in the `ListBox` control.
- Line 75 clears the `ListBox` control's current contents.
- The `foreach` loop in lines 78–86 displays data about each object in the `carList`.
  - The statement in lines 81–82 creates a line of output and assigns it to the `output` variable.
  - Line 85 adds the `output` variable to the `carListBox` control.

---

### Program 8-5 Code for Form1 in the *Car List* application

```

1 using System;
2 using System.Collections.Generic;
3 using System.ComponentModel;
4 using System.Data;
5 using System.Drawing;
6 using System.Linq;
7 using System.Text;
8 using System.Threading.Tasks;
9 using System.Windows.Forms;
10
11 namespace Car_List
12 {
13     struct Automobile
14     {
15         public string make;
16         public int year;
17         public double mileage;
18     }
19
20     public partial class Form1 : Form
21     {
22         // Create a List as a field.
23         private List<Automobile> carList = new List<Automobile>();
24
25         public Form1()
26         {
27             InitializeComponent();
28         }
29
30         // The GetData method gets the data entered
31         // by the user and assigns it to the parameter
32         // object's fields.
33         private void GetData(ref Automobile auto)

```

```

34     {
35         try
36         {
37             // Get the data from the TextBoxes.
38             auto.make = makeTextBox.Text;
39             auto.year = int.Parse(yearTextBox.Text);
40             auto.mileage = double.Parse(mileageTextBox.Text);
41         }
42         catch (Exception ex)
43         {
44             // Display the exception message.
45             MessageBox.Show(ex.Message);
46         }
47     }
48
49     private void addButton_Click(object sender, EventArgs e)
50     {
51         // Create an instance of the Automobile structure.
52         Automobile car = new Automobile();
53
54         // Get the data entered by the user.
55         GetData(ref car);
56
57         // Add the car object to the List.
58         carList.Add(car);
59
60         // Clear the TextBoxes.
61         makeTextBox.Clear();
62         yearTextBox.Clear();
63         mileageTextBox.Clear();
64
65         // Reset the focus.
66         makeTextBox.Focus();
67     }
68
69     private void displayButton_Click(object sender, EventArgs e)
70     {
71         // Declare a string to hold a line of output.
72         string output;
73
74         // Clear the ListBox's current contents.
75         carListBox.Items.Clear();
76
77         // Display the car info in the ListBox.
78         foreach (Automobile aCar in carList)
79         {
80             // Make a line of output.
81             output = aCar.year + " " + aCar.make +
82                 " with " + aCar.mileage + " miles.";
83
84             // Add the line of output to the ListBox.
85             carListBox.Items.Add(output);
86         }
87     }
88 }
89 }

```

---

In Tutorial 8-5 you complete a phone book application that uses a `List` of structure objects.



VideoNote

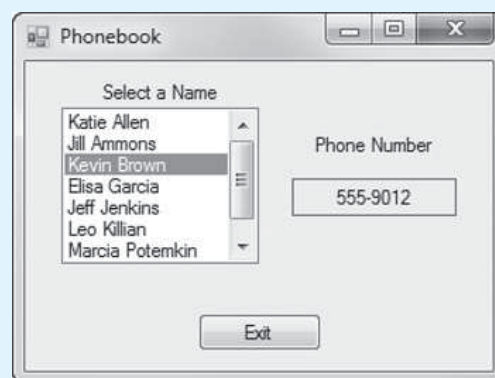
**Tutorial 8-5:**  
Completing the  
*Phonebook*  
Application



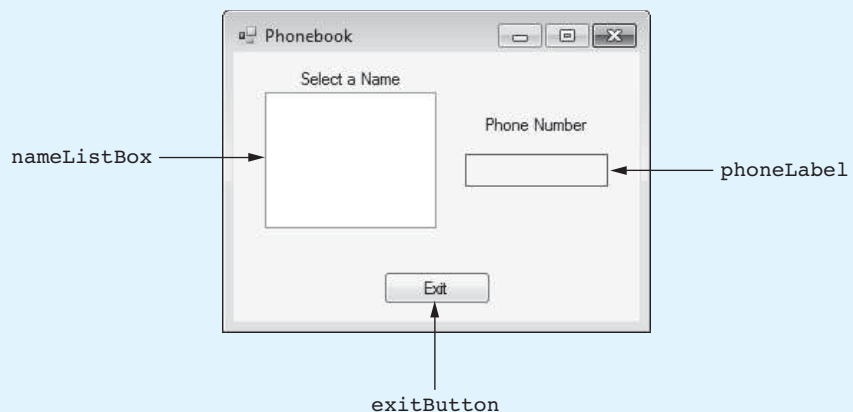
## Tutorial 8-5: Completing the *Phonebook* Application

In this tutorial you complete the *Phonebook* application. When the application is complete, it will let you select a person's name from a `ListBox` control, and then it will display that person's phone number. Figure 8-12 shows an example of how the form will appear at run time. In the figure, Kevin Brown has been selected in the `ListBox` control, and Kevin's phone number is displayed in a `Label` control. The application's form has already been created for you and is shown in Figure 8-13 with the names of some of its controls.

**Figure 8-12** The *Phonebook* application's form with a name selected

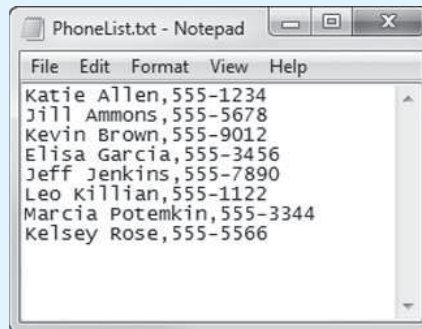


**Figure 8-13** The *Phonebook* application's form



Before you start writing code, let's go over a summary of how the application will work. A file named `PhoneList.txt`, containing several names and corresponding phone numbers, has been created for you. (It is located in the project's `bin\debug` folder.) Its contents are shown in Figure 8-14. Notice that each line in the file contains a name, followed by a comma, followed by a phone number.

When the application starts, the form's `Load` event handler calls a method named `readFile`. The `readFile` method reads the contents of the `PhoneList.txt` file. Each

**Figure 8-14** The contents of the PhoneList.txt file

line that is read from the file will be tokenized, using the comma character as a delimiter. This will result in two `string` tokens: one containing a person's name and the other containing a phone number. The tokens are stored in an instance of the following `PhoneBookEntry` structure:

```
struct PhoneBookEntry
{
    public string name;
    public string phone;
}
```

The `PhoneBookEntry` object is then added to a `List`. When the `ReadFile` method is finished, the `List` will contain a `PhoneBookEntry` object for each line in the `PhoneList.txt` file.

The `Load` event handler then calls another method named `DisplayNames`. The `DisplayNames` method steps through the `List`, getting the `name` field of each object and adding the name to the `ListBox` control. When the `DisplayNames` method is finished, the `ListBox` control will display all the names that are contained in the `List`.

When the user clicks a name in the `ListBox` control, a `SelectedIndexChanged` event occurs. You are to write an event handler that responds to this event. The event handler gets the index of the selected item in the `ListBox` control, and it uses that index to retrieve an object from the `List`. The object contains the phone number for the selected name, which is displayed in a `Label` control.

- Step 1:** Start Visual Studio (or Visual Studio Express). Open the project named *Phonebook* in the *Chap08* folder of the Student Sample Programs.
- Step 2:** Open the `Form1` form's code in the code editor. Type the `using System.IO;` directive shown in line 10 of Program 8-6. This directive is necessary because we will create a `StreamReader` object to read input from a file.
- Step 3:** Write the declaration of the `PhoneBookEntry` structure, shown in lines 14–18. Make sure you write the declaration inside the `Phonebook` namespace, exactly as shown in Program 8-6.
- Step 4:** Next you write the comment and the declaration for `phoneList`, which appears in lines 22–24 in Program 8-6. Notice that `phoneList` is declared as a field in the `Form1` class. It is available to all the methods in the class.
- Step 5:** Write the comments and code for the `ReadFile` method, shown in lines 31–72 of Program 8-6. The `ReadFile` method opens the `PhoneList.txt` file. The `while` loop that begins in line 51 iterates until the end of the file is reached. In each iteration of the loop, the following lines of code are executed:

**Line 54:** This statement reads a line from the file and assigns it to the `line` variable.

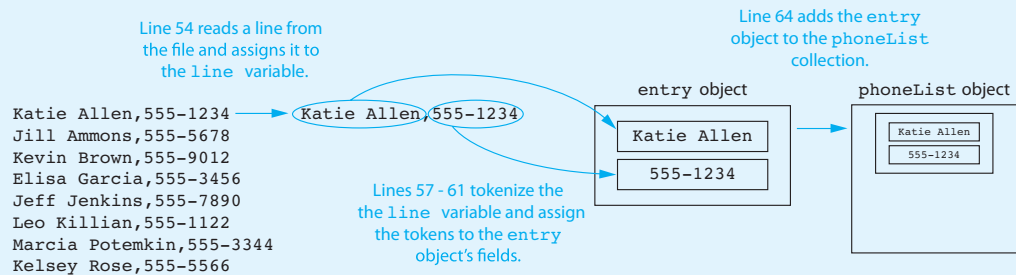
**Line 57:** This statement tokenizes the `line` variable, using the comma character as a delimiter. The tokens are assigned to the `tokens` array. (After this statement executes, `tokens[0]` will contain a name and `tokens[1]` will contain a phone number.)

**Lines 60–61:** These statements assign the tokens to the `name` and `phone` fields of the entry object (which is an instance of the `PhoneBookEntry` structure).

**Line 64:** This statement adds the entry object to the `phoneList` collection.

Figure 8-15 illustrates the steps performed in these lines of code. After the loop is finished, `phoneList` will contain a `PhoneBookEntry` object for each line in the `PhoneList.txt` file.

**Figure 8-15** A summary of lines 54–64



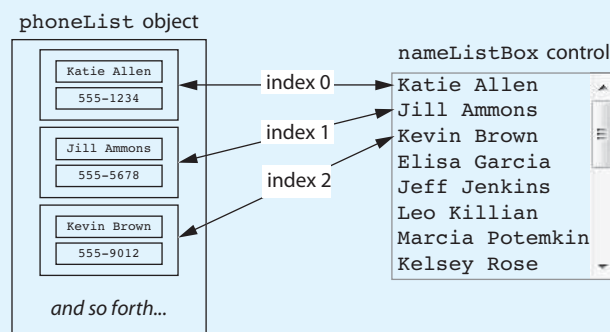
**Step 6:** Write the comments and code for the `DisplayNames` method, shown in lines 74–82 of Program 8-6. The `foreach` loop in line 78 steps through all the objects in `phoneList`. For each object in `phoneList`, line 80 adds the name field to the `nameListBox` control.

Note that the names are added to the `ListBox` control in the same order that they appear in `phoneList`. For example,

- The name “Katie Allen” is at index 0 in the `ListBox`, and the object containing “Katie Allen” is at index 0 in `phoneList`.
- The name “Jill Ammons” is at index 1 in the `ListBox`, and the object containing “Jill Ammons” is at index 1 in `phoneList`.

Figure 8-16 illustrates how the objects in `phoneList` and the names in the `nameListBox` control are related by their indexes. You take advantage of this relationship in Step 7 when you write the code to retrieve an object from `phoneList`.

**Figure 8-16** Objects in `phoneList` and names in `nameListBox` as related by their indexes








**NOTE:** When the items in two data structures are related by their indexes, it is said that a **parallel relationship** exists between the data structures.

**Step 7:** Next you create the form's Load event handler. Switch back to the *Designer* and double-click any part of the form that does not contain a control. This opens the code editor, and you will see an empty event handler named `Form1_Load`. Complete the event handler by typing the code shown in lines 86–90 in Program 8-6. The statement in line 87 calls the `ReadFile` method, and line 90 calls the `DisplayNames` method.

**Step 8:** Now you create the `SelectedIndexChanged` event handler for the `nameListBox` control. Switch back to the *Designer* and double-click the `nameListBox` control. This opens the code editor, and you will see an empty event handler named `nameListBox_SelectedIndexChanged`. Complete the event handler by typing the code shown in lines 95–99 in Program 8-6.

We mentioned in Step 6 that the names in the `ListBox` and the objects in `phoneList` are related by their indexes. When the user selects a name from the `ListBox`, all we have to do is get that item's index and then use that same index to retrieve the corresponding object from `phoneList`. That is exactly what happens in this event handler. Line 96 gets the index of the selected item in the `nameListBox` control and assigns it to the `index` variable. Line 99 uses the `index` variable to get an object from `phoneList`. The retrieved object's `phone` field is assigned to `phoneLabel.Text`.

**Step 9:** Switch your view back to the *Designer* and double-click the `exitButton` control. In the code editor you will see an empty event handler named `exitButton_Click`. Complete the event handler by typing the code shown in lines 104–105 in Program 8-6.

**Step 10:** Save the project. Then, press `(F5)` on the keyboard or click the *Start Debugging* button  on the toolbar to compile and run the application. When the application runs, select various names in the `ListBox` to confirm that the application works properly. When you are finished, click the *Exit* button to exit the application.

#### Program 8-6 Completed code for Form1 in the *Phonebook* application

```

1 using System;
2 using System.Collections.Generic;
3 using System.ComponentModel;
4 using System.Data;
5 using System.Drawing;
6 using System.Linq;
7 using System.Text;
8 using System.Threading.Tasks;
9 using System.Windows.Forms;
10 using System.IO;
11
12 namespace Phonebook
13 {
14     struct PhoneBookEntry
15     {
16         public string name;
17         public string phone;
18     }
19

```

```

20 public partial class Form1 : Form
21 {
22     // Field to hold a list of PhoneBookEntry objects.
23     private List<PhoneBookEntry> phoneList =
24         new List<PhoneBookEntry>();
25
26     public Form1()
27     {
28         InitializeComponent();
29     }
30
31     // The ReadFile method reads the contents of the
32     // PhoneList.txt file and stores it as PhoneBookEntry
33     // objects in the phoneList.
34     private void ReadFile()
35     {
36         try
37         {
38             StreamReader inputFile; // To read the file
39             string line;           // To hold a line from the file
40
41             // Create an instance of the PhoneBookEntry structure.
42             PhoneBookEntry entry = new PhoneBookEntry();
43
44             // Create a delimiter array.
45             char[] delim = { ',', ' ' };
46
47             // Open the PhoneList file.
48             inputFile = File.OpenText("PhoneList.txt");
49
50             // Read the lines from the file.
51             while (!inputFile.EndOfStream)
52             {
53                 // Read a line from the file.
54                 line = inputFile.ReadLine();
55
56                 // Tokenize the line
57                 string[] tokens = line.Split(delim);
58
59                 // Store the tokens in the entry object.
60                 entry.name = tokens[0];
61                 entry.phone = tokens[1];
62
63                 // Add the entry object to the List.
64                 phoneList.Add(entry);
65             }
66         }
67         catch (Exception ex)
68         {
69             // Display an error message.
70             MessageBox.Show(ex.Message);
71         }
72     }
73
74     // The DisplayNames method displays the list of names
75     // in the namesListBox control.
76     private void DisplayNames()
77     {
78         foreach (PhoneBookEntry entry in phoneList)

```

```

79     {
80         nameListBox.Items.Add(entry.name);
81     }
82 }
83
84 private void Form1_Load(object sender, EventArgs e)
85 {
86     // Read the PhoneList.txt file.
87     ReadFile();
88
89     // Display the names.
90     DisplayNames();
91 }
92
93 private void nameListBox_SelectedIndexChanged(object sender, EventArgs e)
94 {
95     // Get the index of the selected item.
96     int index = nameListBox.SelectedIndex;
97
98     // Display the corresponding phone number.
99     phoneLabel.Text = phoneList[index].phone;
100 }
101
102 private void exitButton_Click(object sender, EventArgs e)
103 {
104     // Close the form.
105     this.Close();
106 }
107 }
108 }

```



## Checkpoint

- 8.15 When a structure is declared, what is created in memory?
- 8.16 What does the keyword `public` specify about a field declared in a structure?
- 8.17 When you create an instance of a structure, what are you creating?
- 8.18 What effect does the `new` operator have when creating an instance of a structure?
- 8.19 Once you have created an instance of a structure, how can you access its fields?
- 8.20 Suppose an application contains a structure named `Engine` and that `motor1` and `motor2` are instances of the `Engine` structure. Write a statement that assigns `motor1` to `motor2`.
- 8.21 Write a statement that creates an array named `motors` that can hold 100 `Engine` objects.
- 8.22 What causes a parallel relationship to exist between data structures?

## 8.4

## Enumerated Types

**CONCEPT:** An enumerated data type is a programmer-defined data type. It consists of predefined constants, known as enumerators, that represent integer values.

Sometimes, in a program, you need a way to represent values that cannot be stored in memory in a straightforward manner. For example, suppose you are writing a program that works with the days of the week (Sunday, Monday, Tuesday, etc.), and you need some way to represent each day of the week in memory. One solution is to let the integers 0 through 6 represent the days of the week; 0 could represent Sunday, 1 could represent Monday, and so forth. Although this approach will work, it has some drawbacks.

For example, it may not be clear to anyone else reading the code that the values 0 through 6 represent the days of the week. Also, you might decide that Sunday is the first day of the week, whereas someone else assumes that Monday is the first day of the week. When that other person sees the value 0, he or she might think that it represents Monday.

A better solution for dealing with this type of data is to create an enumerated data type. An **enumerated data type** is a data type that you can create. When you create an enumerated data type, you specify a set of symbolic values that belong to that data type. Here is an example of an enumerated data type declaration:

```
enum Day { Sunday, Monday, Tuesday, Wednesday,
          Thursday, Friday, Saturday }
```

An enumerated data type declaration begins with the keyword `enum`, followed by the name of the type, followed by a list of identifiers inside braces. The example declaration creates an enumerated data type named `Day`. The identifiers `Sunday`, `Monday`, `Tuesday`, `Wednesday`, `Thursday`, `Friday`, and `Saturday`, which are listed inside the braces, are known as **enumerators**. They represent the values that belong to the `Day` data type.



**NOTE:** Notice that the enumerators are not enclosed in quotation marks; therefore, they are not strings. Enumerators must be legal C# identifiers.

The enumerators are constants that represent integer values. When you declare an enumerated type, the enumerators are assigned integer values, starting with 0. For example, in the `Day` data type, the `Day.Sunday` enumerator is assigned the value 0, the `Day.Monday` enumerator is assigned the value 1, and so forth.

An `enum` declaration can appear in any of the following places:

- Outside the application's namespace
- Inside the application's namespace
- Inside a class

In this book we always write `enum` declarations in the same region that we write structure declarations: inside an application's namespace but not inside a class.

Once you have created an enumerated data type in your program, you can declare variables of that type. For example, the following statement declares `workDay` as a variable of the `Day` type:

```
Day workDay;
```

We refer to this as an `enum` variable. Because `workDay` is a variable of the `Day` type, the values that we can assign to it are the `Day` type's enumerators. For example, the following statement assigns the value `Day.Wednesday` to the `workDay` variable:

```
workDay = Day.Wednesday;
```

Notice that we assigned `Day.Wednesday` instead of just `wednesday`. The name `Day.Wednesday` is the fully qualified name of the `Day` type's `wednesday` enumerator.

You have to use an enumerator's fully qualified name because it is possible to have the same enumerator appear in multiple enumerated types. Here is another example:

```
Day weekendDay = Day.Saturday;
```

This statement declares a `Day` variable named `weekendDay` and initializes it with the value `Day.Saturday`.

The following code shows another example. (Assume the application's form has a radio button control named `mondayRadioButton`.)

```
1 Day selectedDay;
2 if (mondayRadioButton.Checked)
3 {
4     selectedDay = Day.Monday;
5 }
```

In this code, line 1 declares a `Day` variable named `selectedDay`. The `if` statement in line 2 determines whether the `mondayRadioButton` control is selected. If it is, the statement in line 4 assigns `Day.Monday` to the `selectedDay` variable.

You can make comparisons with `enum` variables and enumerators. The following code shows an example. (Assume `selectedDay` is a `Day` variable.)

```
1 if (selectedDay == Day.Wednesday)
2 {
3     MessageBox.Show("Halfway through the week!");
4 }
```

The `if` statement in line 1 determines whether the `selectedDay` variable is equal to `Day.Wednesday`. If it is, line 3 displays a message box.

The following code shows how an `enum` variable can be tested in a `switch` statement. (Assume `selectedDay` is a `Day` variable.)

```
1 switch (selectedDay)
2 {
3     case Day.Sunday:
4         MessageBox.Show("Rest.");
5         break;
6     case Day.Monday:
7         MessageBox.Show("Back to work.");
8         break;
9     case Day.Tuesday:
10        MessageBox.Show("Just a regular work day.");
11        break;
12    case Day.Wednesday:
13        MessageBox.Show("Halfway through the week.");
14        break;
15    case Day.Thursday:
16        MessageBox.Show("Almost there.");
17        break;
18    case Day.Friday:
19        MessageBox.Show("Last day!");
20        break;
21    case Day.Saturday:
22        MessageBox.Show("Sleep late today.");
23        break;
24 }
```

In line 1 the `switch` statement tests the `selectedDay` variable. Depending on the value of the variable, the program branches to the appropriate `case` statement.

## Using an Enumerator's or enum Variable's ToString Method

Enumerators and enum variables have a `ToString` method. When you call an enumerator's `ToString` method, it returns the name of the enumerator as a string. For example, the following code will display the string "Sunday" in a message box:

```
MessageBox.Show(Day.Sunday.ToString());
```

When you call an enum variable's `ToString` method, it returns the name of the value that the variable contains, as a string. For example, the following code will display the string "Thursday" in a message box:

```
Day today = Day.Thursday;
MessageBox.Show(today.ToString());
```

When you use the `+` operator with a string and an enum variable, the enum variable's `ToString` method is implicitly called. (The same thing happens when you use the `+` operator with an `int` variable. The `int` variable's `ToString` method is implicitly called.) Here is an example:

```
Day today = Day.Thursday;
MessageBox.Show("Today is " + today);
```

This code will display the string "Today is Thursday" in a message box.

In Tutorial 8-6 you complete an application that uses an enumerated type to represent the colors of the spectrum.



VideoNote

**Tutorial 8-6:**  
Completing the *Color Spectrum* Application

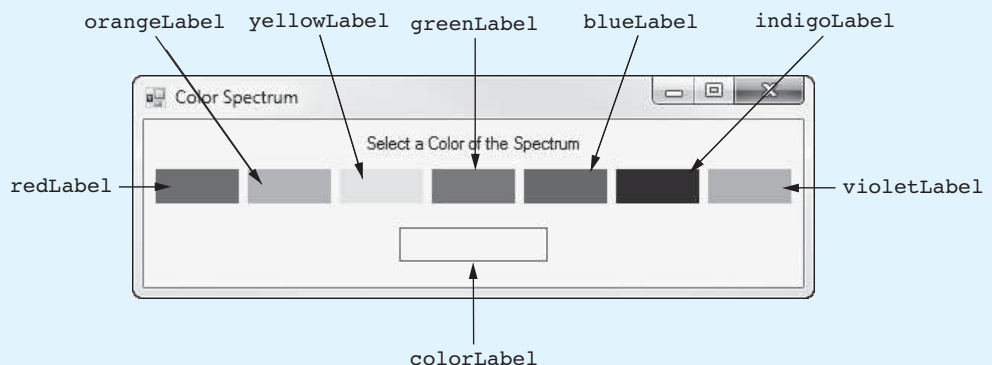


### Tutorial 8-6: Completing the *Color Spectrum* Application

The mnemonic ROY G BIV is commonly used to help remember the following sequence of colors of the visible spectrum: red, orange, yellow, green, blue, indigo, and violet. In this tutorial you complete the *Color Spectrum* application, which shows these colors. The application will display the name of a color if you click it.

The application's form, which has already been created for you, is shown in Figure 8-17. The colors are actually a set of Label controls with their `BackColor` properties set to the appropriate color.

**Figure 8-17** The *Color Spectrum* application's form



- Step 1:** Start Visual Studio (or Visual Studio Express). Open the project named *Color Spectrum* in the *Chap08* folder of the Student Sample Programs.
- Step 2:** Open the Form1 form's code in the code editor. Write the declaration of the *Spectrum* enumerated type, shown in lines 13–17 of Program 8-7. Make sure you write the declaration inside the *Color\_Spectrum* namespace, exactly as shown in Program 8-7. Notice that the enumerators in the *Spectrum* type represent the colors with which you will be working.
- Step 3:** Write the comments and code for the *DisplayColor* method, shown in lines 26–31 of Program 8-6. Notice in line 28 that this method has a parameter variable of the *Spectrum* type. When we call this method, we pass a *Spectrum* enumerator as an argument. In line 30, the name of the enumerator is displayed in the *colorLabel* control.
- Step 4:** Next you create the Click event handlers for the Label controls. Switch back to the *Designer* and double-click the *redLabel* control. This opens the code editor, and you will see an empty event handler named *redLabel\_Click*. Complete the event handler by typing the statement shown in line 35 in Program 8-7. This statement calls the *DisplayColor* method, passing the *Spectrum.Red* enumerator as an argument.
- Step 5:** Repeat this process for the rest of the Label controls, writing the remaining Click event handlers shown in Program 8-7.
- Step 6:** Save the project. Then, press **[F5]** on the keyboard, or click the *Start Debugging* button (🐞) on the toolbar to compile and run the application. When the application runs, click the colors shown on the form to confirm that the application works properly. When you are finished, click the *Exit* button to exit the application.

---

**Program 8-7** Completed code for Form1 in the *Color Spectrum* application

```

1 using System;
2 using System.Collections.Generic;
3 using System.ComponentModel;
4 using System.Data;
5 using System.Drawing;
6 using System.Linq;
7 using System.Text;
8 using System.Threading.Tasks;
9 using System.Windows.Forms;
10
11 namespace Color_Spectrum
12 {
13     enum Spectrum
14     {
15         Red, Orange, Yellow, Green,
16         Blue, Indigo, Violet
17     }
18
19     public partial class Form1 : Form
20     {
21         public Form1()
22         {
23             InitializeComponent();
24         }
25

```

```

26     // The DisplayColor method displays the
27     // name of a color.
28     private void DisplayColor(Spectrum color)
29     {
30         colorLabel.Text = color.ToString();
31     }
32
33     private void redLabel_Click(object sender, EventArgs e)
34     {
35         DisplayColor(Spectrum.Red);
36     }
37
38     private void orangeLabel_Click(object sender, EventArgs e)
39     {
40         DisplayColor(Spectrum.Orange);
41     }
42
43     private void yellowLabel_Click(object sender, EventArgs e)
44     {
45         DisplayColor(Spectrum.Yellow);
46     }
47
48     private void greenLabel_Click(object sender, EventArgs e)
49     {
50         DisplayColor(Spectrum.Green);
51     }
52
53     private void blueLabel_Click(object sender, EventArgs e)
54     {
55         DisplayColor(Spectrum.Blue);
56     }
57
58     private void indigoLabel_Click(object sender, EventArgs e)
59     {
60         DisplayColor(Spectrum.Indigo);
61     }
62
63     private void violetLabel_Click(object sender, EventArgs e)
64     {
65         DisplayColor(Spectrum.Violet);
66     }
67     }
68 }

```

## Getting an Enumerator's or enum Variable's Integer Value

You cannot assign an enumerator directly to an `int` variable, but you can convert an enumerator to its underlying integer type by using a cast operator. Here is an example:

```
int value = (int)Day.Friday;
```

This statement declares an `int` variable named `value` and initializes it with the integer value of `Day.Friday`. After this statement executes, `value` will equal 5. Here is another example:

```
Day workDay = Day.Monday;
int value = (int)workDay;
```



The first statement declares a `Day` variable named `workDay`, initialized with `Day.Monday`. The second statement declares an `int` variable named `value` and initializes it with the integer value of the `workDay` variable. After this statement executes, `value` will equal 1.

## Specifying Integer Values for Enumerators

By default, the enumerators in an enumerated data type are assigned the integer values 0, 1, 2, and so forth. If this is not appropriate, you can specify the values to be assigned, as in the following example.

```
enum Water { Freezing = 32, Boiling = 212 }
```

In this example, the `Water.Freezing` enumerator is assigned the integer value 32 and the `Water.Boiling` enumerator is assigned the integer value 212.

The integer values that you assign to enumerators do not have to be unique. For example, the following code shows an enumerated type named `MonthDays`. Its enumerators are `January`, `February`, `March`, and so forth. Notice that the values assigned to the enumerators are the days of the months (January has 31 days, February has 28 days, etc.). This data type might appear in an application that uses the days of each month.

```
1 enum MonthDays
2 {
3     January = 31, February = 28, March = 31,
4     April = 30, May = 31, June = 30,
5     July = 31, August = 31, September = 30,
6     October = 31, November = 30, December = 31
7 }
```

## Comparing Enumerators and enum Variables

Previously you saw that enumerators and enum variables can be compared using the equality operator (`==`). You can also compare enumerators and enum variables with the other relational operators. For example, using the `Day` data type we have been discussing, the following expression is true.

```
Day.Friday > Day.Monday
```

The expression is true because the enumerator `Day.Friday` is stored in memory as 5 and the enumerator `Day.Monday` is stored as 1. The following code displays the message "Friday is greater than Monday."

```
1 if (Day.Friday > Day.Monday)
2 {
3     MessageBox.Show("Friday is greater than Monday.");
4 }
```

The following code shows another example that compares two enum variables. This code displays the message "Friday is greater than Monday".

```
1 Day day1 = Day.Friday;
2 Day day2 = Day.Monday;
3
4 if (day1 > day2)
5 {
6     MessageBox.Show(day1 + " is greater than " + day2);
7 }
```

Enumerators and enum variables can be compared directly with integer values. For example, the following code displays the message "Sunday is equal to zero."

```

1 if (Day.Sunday == 0)
2 {
3     MessageBox.Show("Sunday is equal to zero.");
4 }

```

## Using an enum Variable to Step through an Array's Elements

Because enumerators represent integer values, they can be used in a loop to step through the elements of an array. For example, look at the following code:

```

1 decimal[] sales = { 1000, 2000, 3000, 4000,
2                     5000, 6000, 7000 };
3
4 for (Day dayCount = Day.Sunday; dayCount <= Day.Saturday; dayCount++)
5 {
6     MessageBox.Show("Sales for " + dayCount + " were " +
7                     sales[(int)dayCount].ToString("c"));
8 }

```

Lines 1 and 2 create a `decimal` array named `sales`. The `for` loop that begins in line 4 uses an enum variable name `dayCount` as its counter variable. Notice the following about the loop:

- The `dayCount` variable is initialized with the value `Day.Sunday`.
- The loop iterates as long as `dayCount` is less than or equal to `Day.Saturday`.
- At the end of each iteration, `dayCount` is incremented.

In line 7 the expression `(int)dayCount` is used as an array subscript. As the loop executes, it displays the following messages:

- "Sales for Sunday were \$1,000.00"
- "Sales for Monday were \$2,000.00"
- "Sales for Tuesday were \$3,000.00"
- "Sales for Wednesday were \$4,000.00"
- "Sales for Thursday were \$5,000.00"
- "Sales for Friday were \$6,000.00"
- "Sales for Saturday were \$7,000.00"

## Checkpoint

8.23 Look at the following declaration.

```
enum Flower { Rose, Daisy, Petunia }
```

- What is the name of the data type?
- In memory, what value will be stored for the enumerator `Flower.Rose`? For `Flower.Daisy`? For `Flower.Petunia`?
- Write a statement that declares a variable of this enumerated type. The variable should be named `flora`. Initialize the variable with the `Flower.Petunia` enumerator.

8.24 What method do you use to display the string value of an enumerator?

8.25 How can you get the integer value of an enumerator?

## 8.5 The ImageList Control

**CONCEPT:** The ImageList control allows you to store a collection of images. At run time, you can retrieve an image from an ImageList control and display it in a PictureBox control.

The **ImageList control** is a container that can hold multiple images. As its name implies, it is a list of images. You can use an index to retrieve an image from an ImageList control and display the image in a PictureBox control.

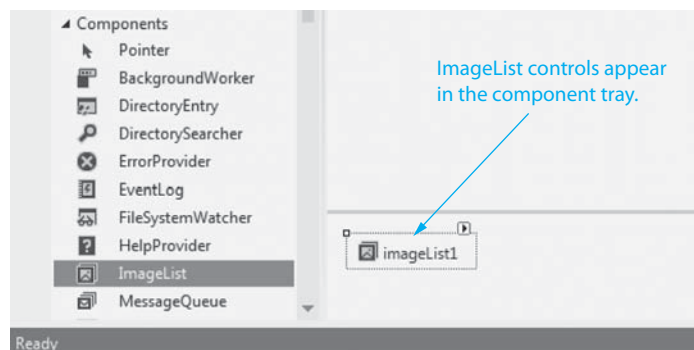
There are a few guidelines that you should follow as you plan to use an ImageList control in an application:

- All the images stored in an ImageList control should be the same size.
- The images stored in an ImageList control can be no more than 256 by 256 pixels in size.
- All the images stored in an ImageList control should be in the same format (.bmp, .jpg, etc.)

Although these guidelines might seem restrictive, keep in mind that ImageList controls are designed to store small images such as icons or thumbnails. They also work well in game programs that display images such as cards.

You will find the ImageList control in the *Components* section of the *Toolbox*. When you double-click the ImageList tool in the *Toolbox*, an ImageList control is created in the component tray area, at the bottom of the *Designer*. (The ImageList control does not appear on the form.) Figure 8-18 shows an example. When you create ImageList controls, they are given default names such as `imageList1`, `imageList2`, and so on.

**Figure 8-18** An ImageList control



After you create an ImageList control, you should set its `ImageSize` property to the size of the images that you plan to store in the control. The default size is 16,16. You can set the `ImageSize` property to any value from 0,0 through 256,256. (If the value of the `ImageSize` property does not match the size of the images that are stored in the control, the images will appear distorted when you display them.)

Then, you can use the `Images` property to add images to the control. In the *Properties* window, click the ellipses button (⋮) that appears next to the `Images` property. This displays the *Images Collection Editor* window shown in Figure 8-19. Click the *Add* button, and an *Open* dialog box appears. Use the dialog box to locate and select the image file (or multiple image files) that you want to add to the ImageList control.

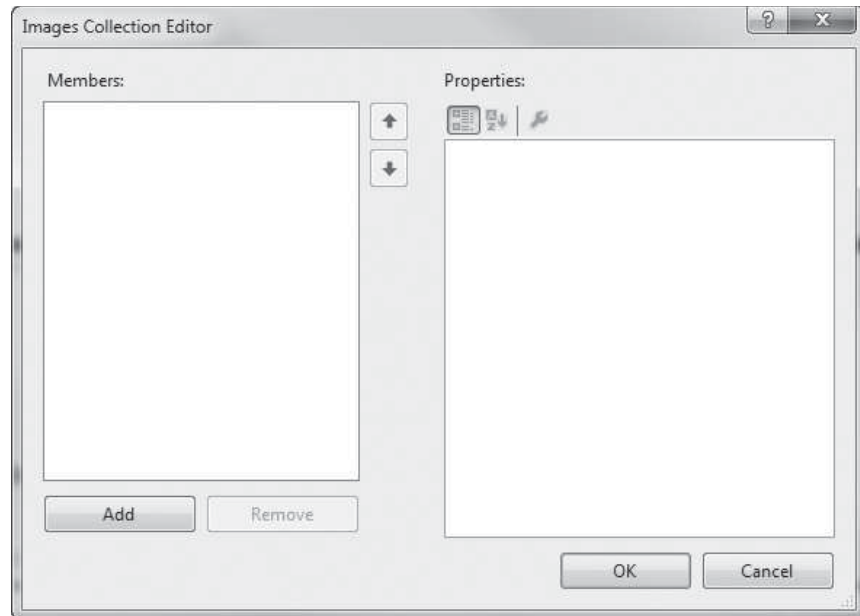
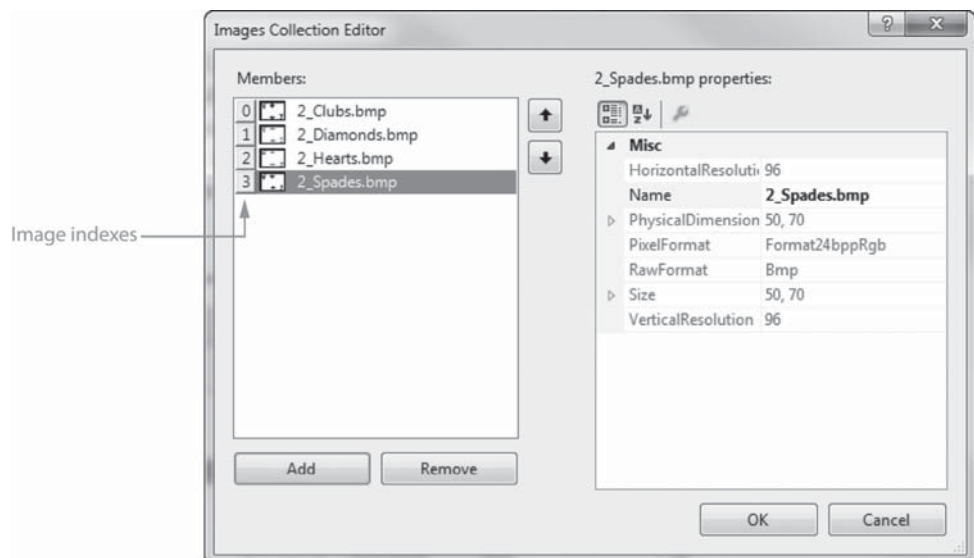
**Figure 8-19** The *Images Collection Editor* window

Figure 8-20 shows the *Images Collection Editor* window after four images have been added. The names of the images, which are shown in the *Members* list, are *2\_Clubs.bmp*, *2\_Diamonds.bmp*, *2\_Hearts.bmp*, and *2\_Spades.bmp*. Notice that an index value appears next to each image's name. You will use the index value later to retrieve images from the control. When you have added all the images that you want, click the *OK* button.

**Figure 8-20** Four images added

If you know the index value for a particular image, you can retrieve that image from the *ImageList* control and display it in a *PictureBox*. The following code shows an example. Assume *myImageList* is the name of an *ImageList* control and *myPictureBox* is the name of a *PictureBox* control.

```
myPictureBox.Image = myImageList.Images[5];
```

This statement gets the image at index 5 from `myImageList` and assigns it to the `myPictureBox` control's `Image` property. As a result, the image is displayed in the `PictureBox`.

In code, you can determine the number of images that are stored in an `ImageList` control by getting the value of the control's `Images.Count` property. The following code shows an example. Assume `myImageList` is the name of an `ImageList` control and `numberImages` is the name of an `int` variable.

```
numberImages = myImageList.Images.Count;
```

In Tutorial 8-7 you complete an application that randomly selects images from an `ImageList` control and displays them in a `PictureBox`.



VideoNote

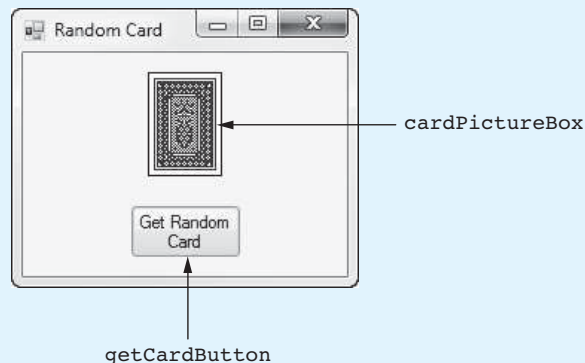
**Tutorial 8-7:**  
Completing the *Random Card*  
Application



## Tutorial 8-7: Completing the *Random Card* Application

In this tutorial you complete the *Random Card* application, which randomly displays images of poker cards selected from an `ImageList` control. The application's form, which has already been created for you, is shown in Figure 8-21. Notice that the `PictureBox` control is already displaying the image of a card's back.

**Figure 8-21** The *Random Card* application's form



- Step 1:** Start Visual Studio (or Visual Studio Express). Open the project named *Random Card* in the *Chap08* folder of the Student Sample Programs.
- Step 2:** Make sure the `Form1` form is open in the *Designer*. Scroll down in the *Toolbox* until you see the *Components* section, and double-click the *ImageList* tool. This should create an `ImageList` control named `imageList1`, which you should see in the component tray.
- Step 3:** Change the name of the `imageList1` control to `cardImageList`.
- Step 4:** Each of the images that you will add to the `cardImageList` control are 50 by 70 pixels in size. Change the `cardImageList` control's `ImageSize` property to 50, 70.
- Step 5:** Next you add images to the `cardImageList` control. The images that you add are in the *Images/Cards/Poker Small* folder of the Student Sample Programs. In the *Properties* window, click the ellipses button (`...`) that appears next to the `Image` property. This displays the *Images Collection Editor* window.

Click the *Add* button, and an *Open* dialog box appears. Use the dialog box to select as many of the card image files as you want to add to the ImageList control. (You can use the Shift or Ctrl key while clicking filenames to select multiple files.) When you have selected all the images that you want to add, click the OK button.

**Step 6:** Now you create the Click event handler for the `getCardButton` control. Double-click the `getCardButton` control in the *Designer*. This opens the code editor, and you will see an empty event handler named `getCardButton_Click`. Complete the event handler by typing the code shown in lines 22–29 in Program 8-8. Let's review this code.

**Line 23:** This statement creates a `Random` object, referenced by the `rand` variable.

**Line 26:** This statement declares an `int` variable named `index`. The variable is initialized with a random number that is returned from the `rand.Next` method. Notice that `cardImageList.Images.Count` is passed as an argument to the method. As a result, we get a random number in the range of 0 up to, but not including, the number of images in the control.

**Line 29:** This statement uses the `index` variable to retrieve an image from the `cardImageList` control and assigns it to the `cardPictureBox` control's `Image` property. As a result, the image is displayed in the `PictureBox`.

**Step 7:** Save the project. Then, press `[F5]` on the keyboard or click the *Start Debugging* button (🐞) on the toolbar to compile and run the application. When the application runs, click the *Get Random Card* button several times to see the images that are randomly selected. When you are finished, click the *Exit* button to exit the application.

---

#### Program 8-8 Completed code for Form1 in the *Random Card* application

```

1 using System;
2 using System.Collections.Generic;
3 using System.ComponentModel;
4 using System.Data;
5 using System.Drawing;
6 using System.Linq;
7 using System.Text;
8 using System.Threading.Tasks;
9 using System.Windows.Forms;
10
11 namespace Random_Card
12 {
13     public partial class Form1 : Form
14     {
15         public Form1()
16         {
17             InitializeComponent();
18         }
19
20         private void getCardButton_Click(object sender, EventArgs e)
21         {
22             // Create a Random object.
23             Random rand = new Random();
24
25             // Get a random index.
26             int index = rand.Next(cardImageList.Images.Count);

```

```
27
28         // Display a card.
29         cardPictureBox.Image = cardImageList.Images[index];
30     }
31 }
32 }
```

## Checkpoint

- 8.26 How you can determine the number of images that are stored in an ImageList control?
- 8.27 Under which section is the ImageList control located in the *Toolbox*?
- 8.28 There are a few guidelines that you should follow as you plan to use an ImageList control in an application. What are they?
- 8.29 How do you add images to an ImageList control?
- 8.30 What value determines which image from the ImageList will be displayed in a PictureBox?

## Key Terms

character literals	leading spaces
comma separated value (CSV)	parallel relationship
Contains method	StartsWith method
delimiter	structure
EndsWith method	substring
enumerated data type	Substring method
enumerators	tokenizing
ImageList control	tokens
IndexOf method	ToLower method
instance	ToUpper method
LastIndexOf method	trailing spaces

## Review Questions

### Multiple Choice

- In C#, \_\_\_\_\_ are enclosed in single quotation marks.
  - strings
  - enumerators
  - tokens
  - character literals
- The char data type provides the \_\_\_\_\_ for converting the case of a character.
  - Lowercase and Uppercase methods
  - ToLower and ToUpper methods
  - IsDigit and IsLetter methods
  - IsWhiteSpace and IsPunctuation methods
- A string within a string is called a(n) \_\_\_\_\_.
  - character
  - inner string
  - substring
  - thread
- The \_\_\_\_\_ of a string object allow you to search for substrings.
  - TrimStart and TrimEnd methods
  - IndexOf and LastIndexOf methods
  - IsWhiteSpace and IsPunctuation methods
  - Contains, StartsWith, and EndsWith methods
- When you want to know the position of the substring, you can use one of the \_\_\_\_\_ of a string object.
  - TrimStart or TrimEnd methods
  - IndexOf or LastIndexOf methods
  - ToLower or ToUpper methods
  - StartsWith or EndsWith methods
- The \_\_\_\_\_ of a string object can be used to retrieve a specific set of characters from a string.
  - Substring method
  - IndexOf method
  - TrimStart and TrimEnd methods
  - StartsWith and EndsWith methods



7. \_\_\_\_\_ are spaces that appear at the beginning of a string.
  - a. Leading spaces
  - b. Primary spaces
  - c. Starting spaces
  - d. Empty spaces
8. \_\_\_\_\_ are spaces that appear at the end of a string.
  - a. Blank spaces
  - b. Secondary spaces
  - c. Ending spaces
  - d. Trailing spaces
9. A series of words or other items of data contained in a string and separated by spaces or other characters are known as \_\_\_\_\_.
  - a. substrings
  - b. elements
  - c. characters
  - d. tokens
10. The character that separates tokens is known as a \_\_\_\_\_.
  - a. partition
  - b. literal
  - c. delimiter
  - d. symbol
11. The process of breaking a string into tokens is known as \_\_\_\_\_.
  - a. extracting
  - b. tokenizing
  - c. delimiting
  - d. parsing
12. The \_\_\_\_\_ file format is commonly used to export spreadsheet data to a text file.
  - a. spreadsheet data volume, or SDV
  - b. comma separated value, or CSV
  - c. extensible markup language, or XML
  - d. portable document format, or PDF
13. A \_\_\_\_\_ is a data type you can create that contains one or more variables known as fields.
  - a. structure
  - b. collection
  - c. volume
  - d. list
14. Before you can use a structure to store data, you must create a(n) \_\_\_\_\_ of the structure in memory.
  - a. copy
  - b. instance
  - c. declaration
  - d. reference
15. When the items in two data structures are related by their indexes, it is said that a \_\_\_\_\_ exists between the data structures.
  - a. binary union
  - b. parallel relationship
  - c. unilateral bond
  - d. virtual connection

16. When you create a(n) \_\_\_\_\_, you specify a set of symbolic values that belong to that data type.
  - a. abstract data type
  - b. symbolic data type
  - c. enumerated data type
  - d. cryptic data type
17. \_\_\_\_\_ are constants that represent integer values.
  - a. Literals
  - b. Enumerators
  - c. Constants
  - d. Tokens
18. The \_\_\_\_\_ is a container that can hold multiple images.
  - a. ImageList control
  - b. GroupBox control
  - c. PictureBox control
  - d. ComboBox control

### True or False

1. You cannot store a string in a variable of the `char` data type.
2. C# allows you to access the individual characters in a string using subscript notation.
3. When you call a `string` object's `Split` method, the method divides the string into two substrings and returns them as an array of strings.
4. The fields contained in a structure must be of the same data type.
5. Before you can use the structure to store data, you must create an instance of the structure in memory.
6. Structure objects can be passed into a method only by reference.
7. You cannot perform comparison operations directly on structure objects.
8. Enumerators must be enclosed in quotation marks.
9. An `enum` declaration can only appear inside the application's namespace.
10. The integer values that you assign to enumerators do not have to be unique.
11. You can compare enumerators and `enum` variables with relational operators.
12. `ImageList` controls are designed to store small images such as icons or thumbnails.

### Short Answer

1. What method can be used to convert a `char` variable to a string?
2. List the method you would use to determine whether each of the following is true or false for the value of a character.
  - a. numeric digit
  - b. alphabetic letter
  - c. alphabetic letter or numeric digit
  - d. punctuation mark
  - e. white-space character
  - f. uppercase letter
  - g. lowercase letter

3. List the method you would use to determine each of the following about the value of a `string` object.
  - a. starts with the substring “VENI”
  - b. contains the substring “VIDI”
  - c. ends with the substring “VICI”
4. Briefly describe each of the following `string` object methods.
  - a. `Insert`
  - b. `Remove`
  - c. `ToLower`
  - d. `ToUpper`
  - e. `Trim`
  - f. `TrimStart`
  - g. `TrimEnd`
5. What characters are used as delimiters when you pass `null` as an argument to the `Split` method of a `string` object?
6. List the places that a structure can be declared in code.
7. Assume an application contains a structure named `Fruit`. Write a statement that demonstrates how you would create a `List` that can hold `Fruit` objects.
8. Can enumerators be used in a loop to step through the elements of an array? Why or why not?
9. Why should you use the `new` operator when creating instances of a structure?
10. What is the result if the value of the `ImageSize` property does not match the size of the images that are stored in the `ImageList` control?

### Algorithm Workbench

1. Write a method that accepts a string as an argument and checks it for proper capitalization and punctuation. The method should determine if the string begins with an uppercase letter and ends with a punctuation mark. The method should return `true` if the string meets the criteria; otherwise it should return `false`.
2. Write a method that accepts a string as an argument and displays its contents backward. For instance, if the string argument is “gravity”, the method should display “ytivarg”.
3. Look at the following structure declaration:
 

```
struct Engine
{
    public int cylinders;
    public int horsepower;
    public int torque;
}
```

Write a method that accepts two `Engine` structures as arguments, determines if the two structures are equal, and returns the Boolean value `true` if the structures are equal or `false` if the structures are not equal.
4. Declare an enumerated data type named `Direction` with enumerators for North, South, East, and West.
5. Write a statement that retrieves the image stored at index 0 from an `ImageList` control named `slideShowImageList` and displays it in a `PictureBox` control named `slideShowPictureBox`.

## Programming Problems

### 1. Word Counter

Create an application with a method that accepts a string as an argument and returns the number of words it contains. For instance, if the argument is "Four score and seven years ago," the method should return the number 6. The application should let the user enter a string, and then it should pass the string to the method. The number of words in the string should be displayed.

### 2. Average Number of Letters

Modify the program you wrote for Problem 1 (Word Counter) so it also displays the average number of letters in each word.

### 3. Sentence Capitalizer

Create an application with a method that accepts a string as an argument and returns a copy of the string with the first character of each sentence capitalized. For instance, if the argument is "hello. my name is Joe. what is your name?" the method should return the string "Hello. My name is Joe. What is your name?" The application should let the user enter a string and then pass it to the method. The modified string should be displayed.

### 4. Vowels and Consonants

Create an application with a method that accepts a string as an argument and returns the number of vowels that the string contains. The application should have another method that accepts a string as an argument and returns the number of consonants that the string contains. The application should let the user enter a string, and should display the number of vowels and the number of consonants it contains.

### 5. Most Frequent Character

Create an application that lets the user enter a string and displays the character that appears most frequently in the string.

### 6. Word Separator

Create an application that accepts as input a sentence in which all the words are run together but the first character of each word is uppercase. Convert the sentence to a string in which the words are separated by spaces and only the first word starts with an uppercase letter. For example the string "StopAndSmellTheRoses." would be converted to "Stop and smell the roses."

### 7. Pig Latin

Create an application that accepts a sentence as input and converts each word to "Pig Latin." In one version, to convert a word to Pig Latin you remove the first letter and place that letter at the end of the word. Then you append the string "ay" to the word. Here is an example:

English: I SLEPT MOST OF THE NIGHT

Pig Latin: IAY LEPTSAY OSTMAY FOAY HETAY IGHNTAY

### 8. Sum of Numbers in a String

Create an application that lets the user enter a string containing series of numbers separated by commas. Here is an example of valid input:

7,9,10,2,18,6

The program should calculate and display the sum of all the numbers.



VideoNote

Solving the  
Sum of  
Numbers in  
a String  
Problem

9. **Alphabetic Telephone Number Translator**

Many companies use telephone numbers like 555-GET-FOOD so the number is easier for their customers to remember. On a standard telephone, the alphabetic letters are mapped to numbers in the following fashion:

- A, B, and C = 2
- D, E, and F = 3
- G, H, and I = 4
- J, K, and L = 5
- M, N, and O = 6
- P, Q, R, and S = 7
- T, U, and V = 8
- W, X, Y, and Z = 9

Create an application that lets the user enter a 10-character telephone number in the format xxx-xxx-xxxx. The application should display the telephone number with any alphabetic characters that appeared in the original translated to their numeric equivalent. For example, if the user enters 555-GET-FOOD, the application should display 555-438-3663.

10. **Morse Code Converter**

Design a program that asks the user to enter a string and then converts that string to Morse code. Morse code is a code where each letter of the English alphabet, each digit, and various punctuation characters are represented by a series of dots and dashes. Table 8-7 shows part of the code.

**Table 8-7** Morse code

Character	Code	Character	Code	Character	Code	Character	Code
space	<i>space</i>	6	- . . . .	G	--.	Q	--.-
comma	-- . . . --	7	-- . . .	H	. . . .	R	. - .
period	. - . . . -	8	--- . .	I	. .	S	...
?	. . . . .	9	---- .	J	. ----	T	-
0	-----	A	. -	K	- . -	U	. . -
1	. ----	B	- . . .	L	. - . .	V	. . . -
2	. . ----	C	- . - .	M	---	W	. ---
3	. . . ---	D	- . .	N	- .	X	- . . -
4	. . . . -	E	.	O	---	Y	- . ---
5	. . . . .	F	. . - .	P	. --- .	Z	--- . .

11. **Drink Vending Machine Simulator**

Create an application that simulates a soft-drink vending machine. The application should let the user select one of the following soft drinks:

- Cola (\$1.00 each)
- Root Beer (\$1.00 each)
- Lemon Lime Soda (\$1.00 each)
- Grape Soda (\$1.50 each)
- Cream Soda (\$1.50 each)

Figure 8-22 shows an example of the application’s form. (The images that are displayed in the PictureBox controls are in the *Images\Drink Machine* folder of the

**Figure 8-22** Drink vending machine simulator

Student Sample Programs.) When the application starts, the vending machine will have 20 of each type of soft drink. Each time the user selects a drink, the application should subtract 1 from the quantity of the selected drink. It should also update and display the total amount of sales. If the user selects a drink that is sold out, a message should be displayed indicating so.

In the application's code, create a structure that has fields for the following data:

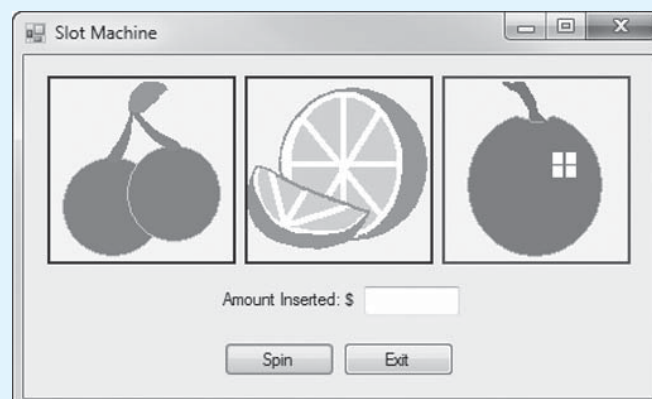
Drink name  
 Drink cost  
 Number of drinks in machine

The program should create an array of five structure objects. Each element of the array should keep data for a specific type of soft drink.

## 12. Slot Machine Simulation

A slot machine is a gambling device into which the user inserts money and then pulls a lever (or presses a button). The slot machine then displays a set of random images. If two or more of the images match, the user wins an amount of money that the slot machine dispenses back to the user.

Create an application that simulates a slot machine. Figure 8-23 shows an example of how the form should look. The application should let the user enter into a

**Figure 8-23** Slot Machine application

TextBox the amount of money he or she is inserting into the machine. When the user clicks the *Spin* button, the application should display three randomly selected symbols. (Slot machines traditionally display fruit symbols. You will find a set of fruit symbols in the *Images\Fruit Symbols* folder of the Student Sample Programs.)

If none of the randomly displayed images match, the program should inform the user that he or she has won \$0. If two of the images match, the program should inform the user that he or she has won two times the amount entered. If three of the images match, the program should inform the user that he or she has won three times the amount entered. When the user clicks the *Exit* button to exit the application, the program should display the total amount of money entered into the slot machine and the total amount won.

## TOPICS

- |  |   |
|--|---|
| 9.1 Introduction to Classes                        | 9.5 Finding the Classes and Their Responsibilities in a Problem |
| 9.2 Properties                                     | 9.6 Creating Multiple Forms in a Project                        |
| 9.3 Parameterized Constructors and Overloading     |   |
| 9.4 Storing Class Type Objects in Arrays and Lists |   |

## 9.1 Introduction to Classes

**CONCEPT:** A class is the blueprint for an object. It specifies the fields and methods a particular type of object has. From the class, one or more objects may be created.

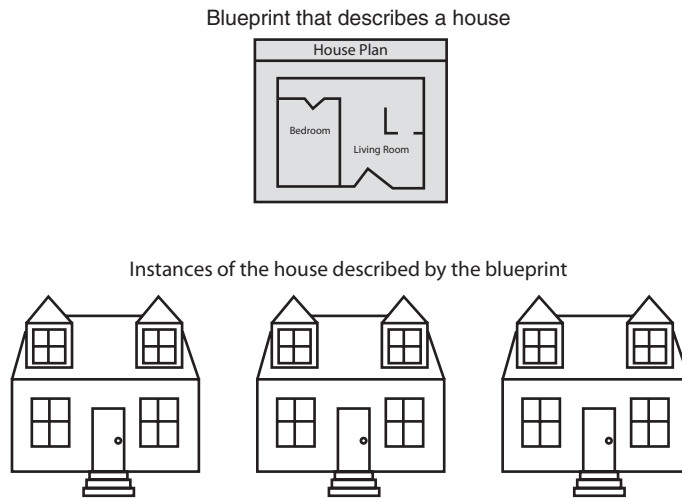
As you have worked through this book, you have used objects extensively in all the programs that you have written. Some objects, such as the controls that you place on a form, are visual. Other objects, such as `Random` objects, arrays, `List` objects, and `ImageList` controls, cannot be seen on the screen but exist in memory and perform important tasks.

We mentioned in Chapter 1 that objects do not just magically appear in your program. Before a specific type of object can be used, that object has to be created in memory. And, before an object can be created in memory, you must have a class for the object.

A class is code that describes a particular type of object. It specifies the data that an object can hold (fields and properties) and the actions that an object can perform (methods). You can think of a class as a code “blueprint” that can be used to create a particular type of object. It serves a similar purpose as the blueprint for a house. The blueprint itself is not a house but is a detailed description of a house. When we use the blueprint to build an actual house, we could say we are building an instance of the house described by the blueprint. If we so desire, we can build several identical houses from the same blueprint. Each house is a separate instance of the house described by the blueprint. This idea is illustrated in Figure 9-1.



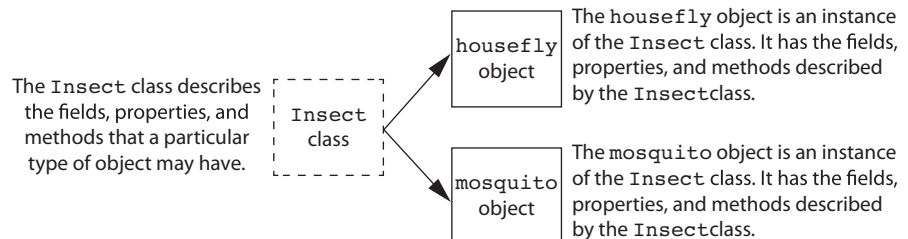
**Figure 9-1** A blueprint and houses built from the blueprint



So, a class is not an object but a description of an object. When the program is running, it can use the class to create, in memory, as many objects of a specific type as needed. Each object that is created from a class is called an **instance** of the class.

For example, Jessica is an entomologist (someone who studies insects), and she also enjoys writing computer programs. She designs a program to catalog different types of insects. As part of the program, she creates a class named `Insect`, which specifies fields, properties, and methods for holding and manipulating data common to all types of insects. The `Insect` class is not an object but a specification that objects may be created from. Next, she writes programming statements that create a `housefly` object, which is an instance of the `Insect` class. The `housefly` object is an entity that occupies computer memory and stores data about a housefly. It has the fields, properties, and methods specified by the `Insect` class. Then she writes programming statements that create a `mosquito` object. The `mosquito` object is also an instance of the `Insect` class. It has its own area in memory and stores data about a mosquito. Although the `housefly` and `mosquito` objects are two separate entities in the computer’s memory, they were both created from the `Insect` class. This means that each object has the fields, properties, and methods described by the `Insect` class. This is illustrated in Figure 9-2.

**Figure 9-2** The `housefly` and `mosquito` objects as instances of the `Insect` class



## Creating a Class

You create a class by writing a **class declaration**. This is the general format of a class declaration:

```
class ClassName
{
    Member declarations go here...
}
```

The first line of a class declaration is known as the **class header**. It starts with the word `class`, followed by the name of the class. The same rules for naming variables apply to naming classes. Most programmers follow the convention of beginning class names with an uppercase letter. This helps to easily distinguish class names from variable names when reading code.

Following the class header is an opening curly brace. Next you write the class's **member declarations**. These are the statements that define the class's fields, properties, and methods. A closing curly brace appears at the end of the class declaration.

Let's look at a simple example. Suppose we are writing a program to simulate the tossing of a coin. In the program we need to repeatedly toss a coin and each time determine whether it landed heads up or tails up. First, we write a class named `Coin` that can perform the behaviors of the coin. The following code sample shows the `Coin` class. (Note that this class is only part of the application's code. In a moment you will see where it should appear in the project, but for now, we concentrate only on this class.)

```

1 class Coin
2 {
3     // Field to represent the side facing up;
4     private string sideUp;
5
6     // Constructor
7     public Coin()
8     {
9         sideUp = "Heads";
10    }
11
12    // The toss method simulates tossing the coin.
13    public void Toss()
14    {
15        // Create a Random object.
16        Random rand = new Random();
17
18        // Use a random number to determine
19        // the side of the coin is facing up.
20        // 0 = Heads, 1 = Tails
21        if (rand.Next(2) == 0)
22        {
23            sideUp = "Heads";
24        }
25        else
26        {
27            sideUp = "Tails";
28        }
29    }
30
31    // The GetSideUp method returns the value
32    // of the sideUp field.
33    public string GetSideUp()
34    {
35        return sideUp;
36    }
37 }

```

The first line is the class header. It specifies that the name of the class is `Coin`. The curly braces that appear in lines 2 and 37 enclose the contents of the class. Let's take a closer look at the code inside the class:

**Line 4:** This statement declares a field named `sideUp`. The `sideUp` field is a `string` variable that indicates which side of the coin is facing up. If the heads side is facing

up, the string "Heads" is assigned to this field. If the tails side is facing up, the string "Tails" is assigned to this field.

Notice that the field declaration begins with the keyword `private`. The keyword `private` is an access modifier that specifies the field cannot be directly accessed by statements outside the class.

By using the `private` access modifier, a class can hide its data from code outside the class. When a class's fields are hidden from outside code, the data is protected from accidental corruption. It is a common practice to make all a class's fields `private` and to provide access to those fields through methods only.

**Lines 7–10:** This code defines a special method known as a constructor. A **constructor** is a method that is automatically executed when an object is created. In most cases, a constructor is used to initialize an object's fields with starting values. It is called a constructor because it helps construct an object.

This constructor performs a simple task. In line 9 it assigns the string "Heads" to the `sideUp` field. As a result, any time we create an object of the `Coin` class, that object's `sideUp` field will initially be assigned the string "Heads".

Notice the following about the constructor header in line 7:

- The name of the constructor is the same as the name of the class. In this case, the name of the constructor is `Coin`.
- The header does not specify a return type—not even `void`.
- The constructor header begins with the `public` access modifier. In most cases, a class's constructor is `public`. In this book we always use the `public` access modifier with constructors.

**Lines 13–29:** This code defines a `void` method named `Toss`. Notice that the `public` access modifier is used in the method header in line 13. Because the method is `public`, it can be called from code outside the `Coin` class.

The purpose of the `Toss` method is to simulate the tossing of the coin. When the method is called, line 16 creates a `Random` object, referenced by the `rand` variable. The `if` statement in line 21 gets a random number in the range of 0 through 1. If the number is 0, then line 23 assigns the string "Heads" to the `sideUp` field. Otherwise, line 27 assigns the string "Tails" to the `sideUp` field.

**Lines 33–36:** This code defines a method named `GetSideUp`. Notice that the `public` access modifier is used in line 33, which means that the method can be called from code outside the `Coin` class. Also notice that the method returns a `string`.

The purpose of the `GetSideUp` method is to return a string indicating which side of the coin is facing up. Notice that in line 35 the value of the `sideUp` field is returned.

## Creating an Object

Remember, a class is not an object but a description of an object. The `Coin` class specifies what a `Coin` object is made of, but it does not create a `Coin` object in memory. To create a `Coin` object, we must write a statement such as this:

```
Coin myCoin = new Coin();
```

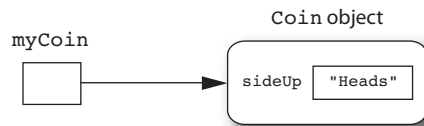
At this point in your studies, you have created plenty of objects, so this type of statement will be familiar to you. For example, `Random` objects, arrays, and `Lists` are all created this way. Let's look at the different parts of this statement:

- The first part of the statement, appearing on the left side of the `=` operator, reads `Coin myCoin`. This declares a variable named `myCoin` that can be used to reference an object of the `Coin` class.

- The second part of the statement, appearing on the right side of the = operator, reads `new Coin()`. This expression creates an instance of the `Coin` class and calls the class's constructor. The `new` operator returns a reference to the object.
- The = operator assigns the reference that was returned from the `new` operator to the `myCoin` variable.

After this statement executes, the `myCoin` variable will reference a `Coin` object, as shown in Figure 9-3. Notice in the figure that the object's `sideUp` field is set to "Heads", as a result of the constructor.

**Figure 9-3** The `myCoin` variable references a `Coin` object



**NOTE:** Classes are reference types. When you create an object from a class, you use a reference variable to reference that object. When you want to work with the object, you use the variable that references it.

Once we have created a `Coin` object, we can perform operations with it. For example, assuming the variable `myCoin` references a `Coin` object, the following statement calls the object's `Toss` method:

```
myCoin.Toss();
```

And, the following statement displays the side of the coin that is facing up:

```
MessageBox.Show(myCoin.GetSideUp());
```

## Where to Write Class Declarations

In C# you have some flexibility in choosing where to write class declarations. When you start writing your own classes in a project, it is possible to write them in the same file that contains the form's class. Figure 9-4 shows an example of how the `Coin` class can be written in the same file as a project's `Form1` class. Notice in the figure that the `Coin` class is written inside the project namespace. This is not required, but it is a good idea since the class is part of the project. (It does not matter if the class is written before or after the `Form1` class.)

Although this approach might be acceptable for small classes, it is recommended that you write each class in its own separate file. Doing so makes your code more organized and helps keep your source code files to a manageable size. It also makes it easy for you to reuse classes in other projects. In this book, we always store classes in their own files.

**Figure 9-4** The `Form1` class and the `Coin` class in the same source code file

```

using System;
using System.Collections.Generic;
using System.ComponentModel;
using System.Data;
using System.Drawing;
using System.Linq;
using System.Text;
using System.Threading.Tasks;
using System.Windows.Forms;

namespace Example
{
    public partial class Form1 : Form
    {
        public Form1()
        {
            InitializeComponent();
        }
        Form1's methods and event handlers appear here.
    }

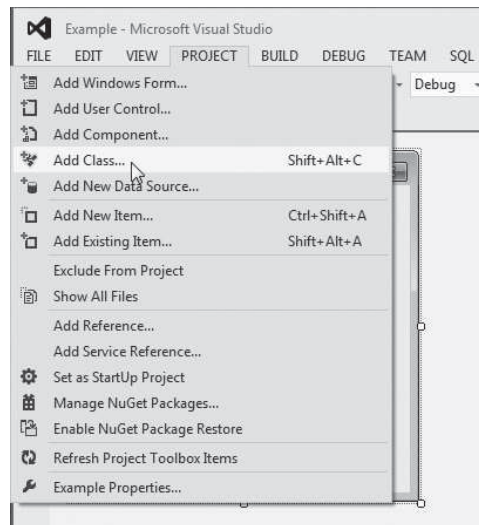
    class Coin
    {
        The Coin class's members appear here.
    }
}

```

Visual Studio automates the process of adding a new class file to a project. When you are ready to write a new class, follow these steps to create a source file for the class:

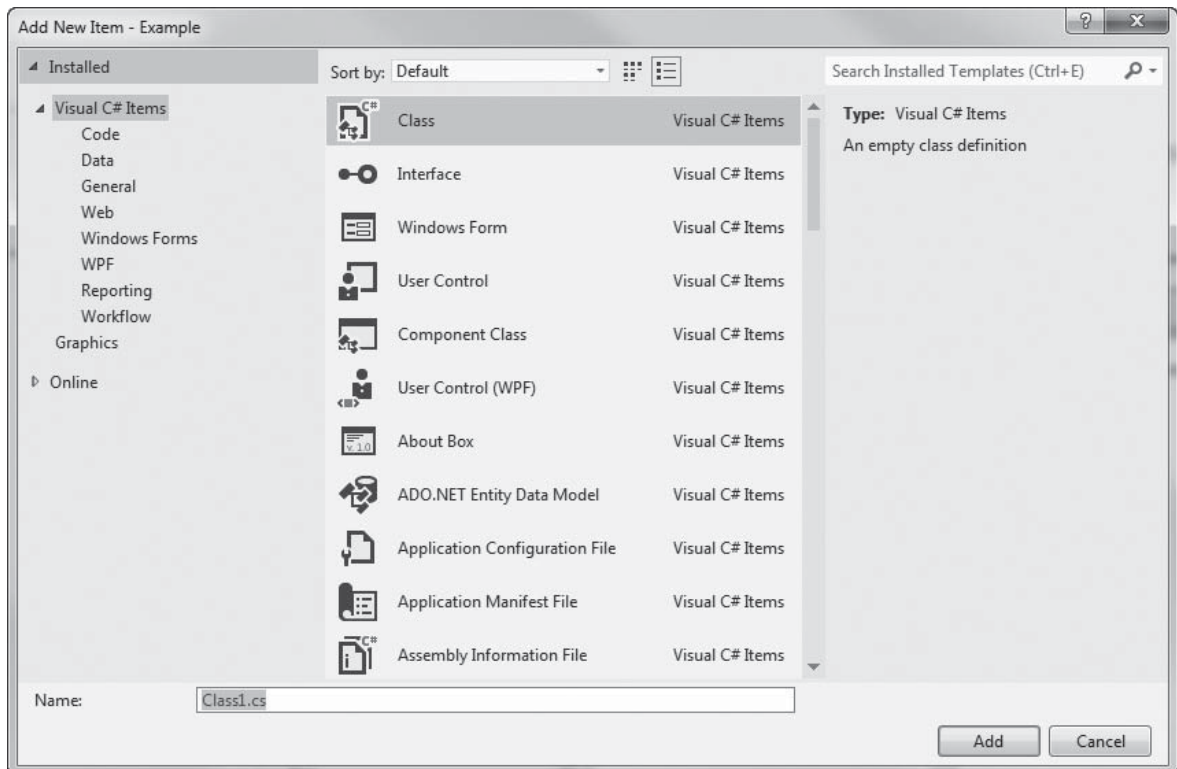
1. With the project open in Visual Studio, click *PROJECT* on the menu bar; then select *Add Class...*. This is shown in Figure 9-5.

**Figure 9-5** Selecting *Add Class...* on the *PROJECT* menu



2. The *Add New Item* window, shown in Figure 9-6, should appear. Make sure *Class* is selected as the type of item. Notice in the figure that *Class1.cs* appears in the *Name* text box. This is the default filename that Visual Studio provides. Change the name

Figure 9-6 The Add New Item window

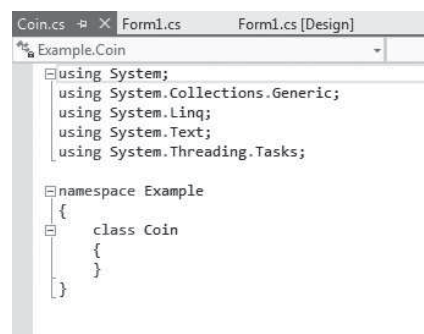


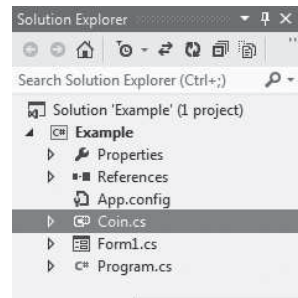
to match the name of the class that you are creating. For example, if you are creating a class named `Coin`, you change the name to `Coin.cs`. (Be sure that the filename ends with the `.cs` extension.)

3. Click the *Add* button.

After performing these steps, the specified source code file will be created in the project and will be displayed in the code editor. The source code file already contains several `using` directives and an empty class declaration that you can edit. Figure 9-7 shows an example. You will also see an entry for the new source code file in the *Solution Explorer*, as shown in Figure 9-8.

Figure 9-7 A new class file displayed in the code editor



**Figure 9-8** Solution Explorer window

Tutorial 9-1 leads you through the process of creating the `Coin` class in an application that uses it to simulate a coin that can be tossed.



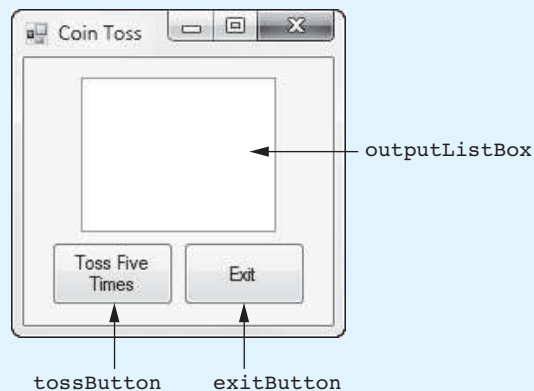
### Tutorial 9-1: Creating and Using the `Coin` Class



VideoNote

**Tutorial 9-1:**  
Creating and  
Using the  
`Coin` class

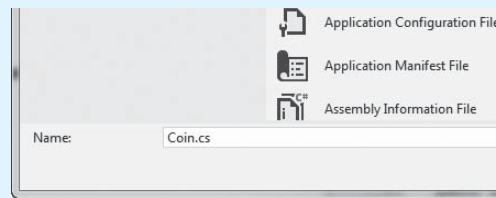
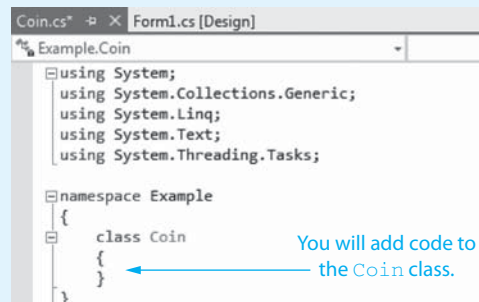
In this tutorial you complete the *Coin Toss* application. The application's form, which has already been created for you, is shown in Figure 9-9. When you run the completed application, you can click the *Toss Five Times* button and the application will simulate a coin being tossed five times. The results of each coin toss are displayed in the list box.

**Figure 9-9** The *Coin Toss* application's form

**Step 1:** Start Visual Studio (or Visual Studio Express). Open the project named *Coin Toss* in the *Chap09* folder of the Student Sample Programs.

**Step 2:** Click *PROJECT* on the Visual Studio menu bar; then select *Add Class...*. The *Add New Item* window should appear. (See Figure 9-6 for an example.) Make sure *Class* is selected as the type of item. Notice that the default filename *Class1.cs* appears in the *Name* text box. Change the name to *Coin.cs*, as shown in Figure 9-10, and then click the *Add* button. This adds a source code file named *Coin.cs* to the project.

**Step 3:** The *Coin.cs* file should now be displayed in the code editor, as shown in Figure 9-11. Notice that the file already contains several `using` directives and an empty `Coin` class has been created. Complete the code for the `Coin` class by typing lines 11–45 in Program 9-1.

**Figure 9-10** The filename changed to Coin.cs**Figure 9-11** The Coin.cs file in the code editor

**Step 4:** Next you create the Click event handlers for the Button controls. Click the tab that reads *Form1.cs [Design]* in the area just above the code editor to switch your view to the Form1 form in the Designer. (Alternatively, you can double-click the *Form1.cs* entry in the *Solution Explorer*.)

**Step 5:** Double-click the `tossButton` control. This opens the *Form1.cs* file in the code editor, and you will see an empty event handler named `tossButton_Click`. Complete the event handler by typing the code shown in lines 22–36 in Program 9-2. Let's review this code:

**Line 23:** This statement does the following:

- It declares a `Coin` reference variable named `myCoin`.
- It creates a `Coin` object in memory and calls its constructor.
- It assigns a reference to the `Coin` object to the `myCoin` variable.

After this statement executes, the `myCoin` variable will reference a `Coin` object. The object's `sideUp` field will be set to "Heads".

**Line 26:** This statement clears the `outputListBox` control.

**Lines 29–36:** This `for` loop iterates five times, simulating five tosses of a coin. During each iteration, the following actions take place:

- Line 32 calls the `myCoin.Toss()` method.
- Line 35 calls the `myCoin.GetSideUp()` method to get the side of the coin that is facing up. The result of the method call is displayed in the `outputListBox` control.

**Step 6:** Switch your view back to the Form1 form in the *Designer* and double-click the `exitButton` control. In the code editor you will see an empty event handler named `exitButton_Click`. Complete the event handler by typing the code shown in lines 41–42 in Program 9-2.



**Step 7:** Save the project. Then, press **F5** on the keyboard or click the *Start Debugging* button (▶) on the toolbar to compile and run the application. When the application runs, click the *Toss Five Times* button and view the results. Figure 9-12 shows an example of the application's output. Click the button as many times as you wish to see different, random results. Click the *Exit* button when you are finished.

**Figure 9-12** Example output of the *Coin Toss* application



**Program 9-1** Completed code for the *Coin.cs* file in the *Coin Toss* application

```

1 using System;
2 using System.Collections.Generic;
3 using System.Linq;
4 using System.Text;
5 using System.Threading.Tasks;
6
7 namespace Coin_Toss
8 {
9     class Coin
10    {
11        // Field to represent the side facing up;
12        private string sideUp;
13        Random rand = new Random();
14
15        // Constructor
16        public Coin()
17        {
18            sideUp = "Heads";
19        }
20
21        // The toss method simulates tossing the coin.
22        public void Toss()
23        {
24            // Create a Random object.
25            //Random rand = new Random();
26
27            // Use a random number to determine
28            // the side of the coin is facing up.
29            // 0 = Heads, 1 = Tails
30            if (rand.Next(2) == 0)
31            {
32                sideUp = "Heads";
33            }
34            else
35            {
36                sideUp = "Tails";

```

```

37         }
38     }
39
40     // The GetSideUp method returns the value
41     // of the sideUp field.
42     public string GetSideUp()
43     {
44         return sideUp;
45     }
46 }
47 }

```

---

### Program 9-2 Completed code for Form1 in the *Coin Toss* application

```

1 using System;
2 using System.Collections.Generic;
3 using System.ComponentModel;
4 using System.Data;
5 using System.Drawing;
6 using System.Linq;
7 using System.Text;
8 using System.Threading.Tasks;
9 using System.Windows.Forms;
10
11 namespace Coin_Toss
12 {
13     public partial class Form1 : Form
14     {
15         public Form1()
16         {
17             InitializeComponent();
18         }
19
20         private void tossButton_Click(object sender, EventArgs e)
21         {
22             // Create a Coin object.
23             Coin myCoin = new Coin();
24
25             // Clear the ListBox.
26             outputListBox.Items.Clear();
27
28             // Toss the coin five times.
29             for (int count = 0; count < 5; count++)
30             {
31                 // Toss the coin.
32                 myCoin.Toss();
33
34                 // Display the side that is up.
35                 outputListBox.Items.Add(myCoin.GetSideUp());
36             }
37         }
38
39         private void exitButton_Click(object sender, EventArgs e)
40         {
41             // Close the form.
42             this.Close();
43         }
44     }
45 }

```

---

## Passing an Object to a Method

When you are developing applications that work with objects, you often need to write methods that accept objects as arguments. For example, the following code shows a method named `ShowCoinStatus` that accepts a `Coin` object as an argument:

```
1 private void ShowCoinStatus(Coin coin)
2 {
3     MessageBox.Show("This side of the coin is up: " +
4                     coin.GetSideUp());
5 }
```

The following code sample shows how we might create a `Coin` object and then pass it as an argument to the `ShowCoinStatus` method:

```
Coin myCoin = new Coin();
ShowCoinStatus(myCoin);
```

Because classes are reference types, objects that are instances of a class are *always* passed by reference. When you pass an object that is an instance of a class as an argument, the thing that is passed into the parameter variable is a reference to the object. As a result, the method that receives the object as an argument has access to the actual object (not a copy of the object). For example, look at the following `Flip` method:

```
1 private void Flip(Coin coin)
2 {
3     coin.Toss();
4 }
```

This method accepts a `Coin` object as an argument, and it calls the object's `Toss` method. The following code demonstrates the method being called:

```
1 // Create a Coin object.
2 Coin myCoin = new Coin();
3
4 // This will display "Heads".
5 MessageBox.Show(myCoin.GetSideUp());
6
7 // Pass the object to the Flip method.
8 Flip(myCoin);
9
10 // This might display "Heads", or it might
11 // display "Tails".
12 MessageBox.Show(myCoin.GetSideUp());
```

The statement in line 2 creates a `Coin` object, referenced by the variable `myCoin`. Line 5 displays the value of the `myCoin` object's `sideUp` field. Because the object's constructor set the `sideUp` field to "Heads", we know that line 5 will display the string "Heads". Line 8 calls the `Flip` method, passing the `myCoin` object as an argument, by reference. Inside the `Flip` method, the `myCoin` object's `Toss` method is called. Line 12 displays the value of the `myCoin` object's `sideUp` field again. This time, we cannot predict whether "Heads" or "Tails" will be displayed because the `myCoin` object's `Toss` method has been called.



### Checkpoint

- 9.1 How is a class like a blueprint?
- 9.2 Briefly describe the process of writing a class declaration.
- 9.3 What is a constructor?

- 9.4 List the three steps for adding a new class file to a Visual C# project.
- 9.5 When you pass an object that is an instance of a class as an argument, what is passed into the parameter variable?

## 9.2 Properties

**CONCEPT:** A property is a class member that holds a piece of data about an object. Properties are implemented as special methods that set and get the values of corresponding fields.

A **property** is a special type of class member that allows an object to store and retrieve a piece of data. You are already familiar with properties because you have used them extensively when creating forms. GUI controls have properties that determine their characteristics. For example, a Label control's Text property determines the text that is displayed by the control.

In code, you work with properties in the same ways that you work with variables. For example, assume `messageLabel` is the name of a Label control. You can assign a specific value to the control's Text property, as shown here:

```
messageLabel.Text = "Hello";
```

Also, you can assign a property to a variable. The following statement initializes the variable `str` with the `messageLabel` control's Text property:

```
string str = messageLabel.Text;
```

From these examples, you can see that a property is a class member that behaves like a public field. A property is not a public field, however. It is a special set of methods, known as **accessors**, which work in conjunction with a private field. The private field, which is known as the property's **backing field**, holds any data that is assigned to the property. The accessors allow code outside the class to get the property's value and assign values to the property.

Let's look at an example of a simple class that has a property. Suppose you want to create a class named `Pet` that represents the family pet. The class will have a Name property to hold the pet's name. The following code shows how the `Pet` class might be written:

```

1 class Pet
2 {
3     // Field for the pet's name
4     private string _name;
5
6     // Constructor
7     public Pet()
8     {
9         _name = "";
10    }
11
12    // Name property
13    public string Name
14    {
15        get
16        {
17            return _name;
18        }
19
20        set
21        {

```

```

22         _name = value;
23     }
24 }
25 }

```

Let's take a closer look at the code inside the class:

**Line 4:** This statement declares a private `string` field named `_name`. The `_name` field is the backing field for the `Name` property. When a value is assigned to the `Name` property, it is stored in the `_name` field.

Notice that we have started the field's name with an underscore character. This is not a requirement, but some programmers begin the names of backing fields with an underscore to eliminate confusion between the field name and the property name. By following this practice, when you are reading the code and you see a variable name that begins with an underscore, you know immediately that it is a backing field for a property.

**Lines 7–10:** This is the class constructor. When an instance of the `Pet` class is created, this constructor assigns an empty string to the `_name` field.

**Line 13:** This is the beginning of a property declaration. It specifies three things about the property:

- `public`—The property is public, so it can be used by code outside the class. (Most properties are declared as public.)
- `string`—The property's data type is `string`.
- `Name`—The name of the property is `Name`.

**Line 14:** An opening curly brace appears in this line. The corresponding closing curly brace appears in line 24. Inside these braces are the `Name` property's accessors.

**Lines 15–18:** This is the property's `get` accessor. You can think of the `get` accessor as a method that returns the property's value. You can see that line 17 is a `return` statement, returning the value of the `_name` field. The `get` accessor is executed any time the property is read.

**Lines 20–23:** This is the property's `set` accessor. The purpose of the `set` accessor is to set the property to a value. The `set` accessor has an implicit parameter named `value`. It is "implicit" because it is not declared, as the parameters in a regular method are. The **value parameter** is automatically created by the compiler, and its data type is the same as that of the property. In this case, the `value` parameter's data type is `string`.

Any time a value is assigned to a property, the property's `set` accessor is executed, and the value being assigned is passed into the `value` parameter. Line 22 assigns the `value` parameter to the `_name` field.

The following code shows how you can use the `Pet` class's `Name` property.

```

1 // Create two Pet objects.
2 Pet myDog = new Pet();
3 Pet myCat = new Pet();
4
5 // Set their Name properties.
6 myDog.Name = "Fido";
7 myCat.Name = "Sylvester";
8
9 // Display their names.
10 MessageBox.Show("My dog's name is " + myDog.Name);
11 MessageBox.Show("My cat's name is " + myCat.Name);

```

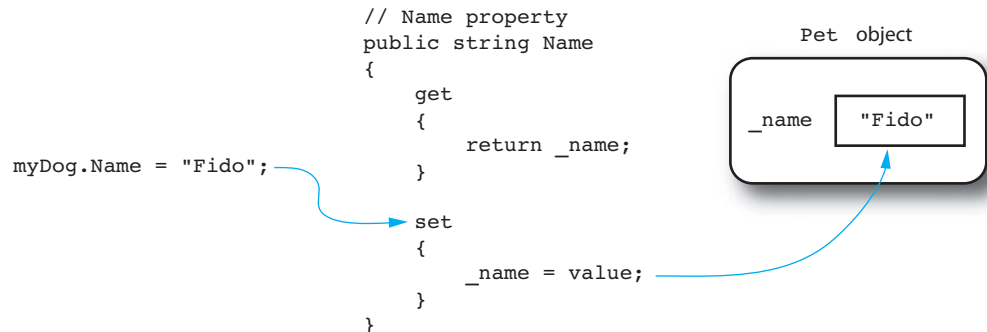
Let's take a closer look at the code:

**Line 2:** This statement creates a `Pet` object, calls the `Pet` class constructor, and assigns a reference to the object to the `myDog` variable. After this statement executes, the `myDog` variable references a `Pet` object.

**Line 3:** This statement creates a `Pet` object, calls the `Pet` class constructor, and assigns a reference to the object to the `myCat` variable. After this statement executes, the `myCat` variable references a `Pet` object.

**Line 6:** This statement sets the `myDog` object's `Name` property to "Fido". When this statement executes, the `Name` property's `set` accessor is executed, and the string "Fido" is passed into the `value` parameter. The `value` parameter is then assigned to the `myDog` object's `_name` field. This process is illustrated in Figure 9-13.

**Figure 9-13** Setting the `myDog` object's `Name` property to "Fido"



**Line 7:** This statement sets the `myCat` object's `Name` property to "Sylvester". When this statement executes, the `Name` property's `set` accessor is executed, and the string "Sylvester" is passed into the `value` parameter. The `value` parameter is then assigned to the `myCat` object's `_name` field.

**Line 10:** This statement displays the message "My dog's name is Fido" in a message box. When the `myDog` object's `Name` property is retrieved, the `get` accessor returns the value of the object's `_name` field.

**Line 11:** This statement displays the message "My cat's name is Sylvester" in a message box. When the `myCat` object's `Name` property is retrieved, the `get` accessor returns the value of the object's `_name` field.

When an accessor contains only a single statement, many programmers prefer to write the entire accessor in one line of code. For example, the `Name` property in the `Pet` class could have been written like this:

```

// Name property
public string Name
{
    get { return _name; }
    set { _name = value; }
}

```

This concise style of writing accessors reduces the number of lines code in a class declaration without sacrificing the code's readability. From this point forward in the book, we will use this style when an accessor has only one statement.

## Properties versus Public Fields

At this point, you might be wondering why you should go to the trouble of creating a property when it would be easier to simply create a public field. For example, in the `Pet` class, couldn't we have just declared a public `string` field named `Name`? If the field is public, it can be directly accessed by code outside the class without the need for accessors.

It is possible to take that approach, but it is not recommended. Class fields are almost always declared `private` in order to protect them from accidental corruption. When code outside the class needs to access a field, it does so through public methods (or, in the case of a property, through accessors). This ensures that the object owning the fields is in control of all changes being made to them.

## Passing Properties as Arguments

You can pass a property as an argument to a method. For example, line 8 in the following code sample passes a `Pet` object's `Name` property as an argument to the `MessageBox.Show` method.

```
1 // Create a Pet object.
2 Pet myDog = new Pet();
3
4 // Set the object's Name property.
5 myDog.Name = "Fido";
6
7 // Display the Name property.
8 MessageBox.Show(myDog.Name);
```

When you pass a property as an argument to a method, there is one restriction: Properties can be passed only by value. If you try to pass a property to a `ref` or an `out` parameter, an error occurs.

Tutorial 9-2 leads you through the process of creating a class with properties. You use the class in a simple application that creates an object of the class and tests its properties.



VideoNote

**Tutorial 9-2:**  
Creating and  
Using the  
`CellPhone`  
Class



### Tutorial 9-2: Creating and Using the `CellPhone` Class

Suppose you work as a programmer for a company that sells cell phones and wireless service. Your department is creating an application to manage the company's inventory of cells phones. You have been asked to create a class that represents a cell phone. The class should keep the following data about a cell phone:

- The phone's brand name
- The phone's model
- The phone's retail price

The class should have the following public properties:

- `Brand`—a `string` property that will store the phone's brand name
- `Model`—a `string` property that will store the phone's model
- `Price`—a `decimal` property that will store the phone's retail price

The class should have the following private fields:

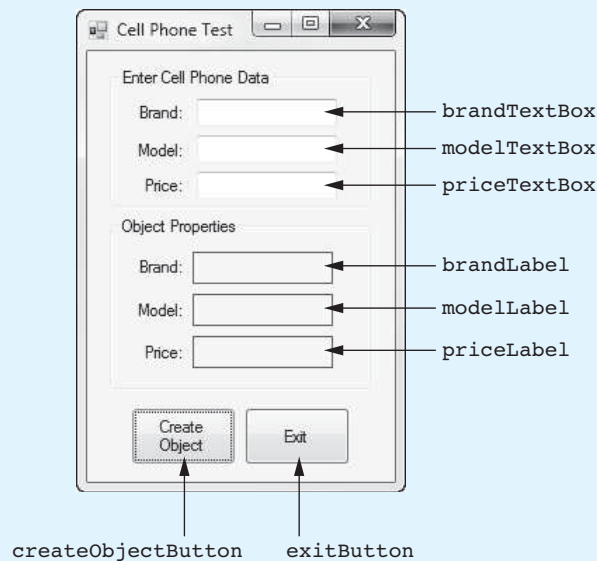
- `_brand`—a `string` that serves as the backing field for the `Brand` property
- `_model`—a `string` that serves as the backing field for the `Model` property
- `_price`—a `decimal` that serves as the backing field for the `Price` property

The class should also have a constructor that initializes the private fields. The `_brand` and `_model` fields will be initialized with empty strings, and the `_price` field will be initialized with the value 0.

You create the `CellPhone` class in a project that will create an object of the class and test the object's properties. The project is named *Cell Phone Test* and has already been started

for you; it is located in the *Chap09* folder of the Student Sample Programs. Figure 9-14 shows the application's form. At run time, you enter sample cell phone data into the text boxes and then click the *Create Object* button. The application creates an object of the `CellPhone` class and assigns the data from the text boxes to the object's properties. It then reads and displays the values of the object's properties in the `brandLabel`, `modelLabel`, and `priceLabel` controls.

**Figure 9-14** The *Cell Phone Test* application's form



**Step 1:** Start Visual Studio (or Visual Studio Express). Open the project named *Cell Phone Test* in the *Chap09* folder of the Student Sample Programs.

**Step 2:** Click *PROJECT* on the Visual Studio menu bar and then select *Add Class...*. The *Add New Item* window should appear. Make sure *Class* is selected as the type of item. Change the default filename to *CellPhone.cs* and then click the *Add* button. This adds a source code file named *CellPhone.cs* to the project.

**Step 3:** The *CellPhone.cs* file should now be displayed in the code editor. Complete the code for the `CellPhone` class by typing lines 11–43 in Program 9-3.

**Step 4:** Open the *Form1.cs* file in the code editor. Type the comments and code for the `GetPhoneData` method, shown in lines 20–44 of Program 9-4. Notice in line 23 that the method has a `CellPhone` parameter named `phone`. When we call this method, we pass a `CellPhone` object to it as an argument.

The purpose of the `GetPhoneData` method is to read the data that the user has entered into the form's text boxes and store that data in the `CellPhone` object's properties. Let's review this code:

**Line 26:** This statement declares a local `decimal` variable named `price`. This variable temporarily holds the value that the user entered for the phone's price while we perform input validation on that value.

**Line 29:** This statement assigns the `brandTextBox` control's `Text` property to the phone object's `Brand` property.

**Line 32:** This statement assigns the `modelTextBox` control's `Text` property to the phone object's `Model` property.



**Lines 35–43:** The `if` statement in line 35 calls the `decimal.TryParse` method to convert the `priceTextBox` control's `Text` property to a `decimal`, and it stores the result in the `price` variable. If the conversion is successful, line 37 assigns the `price` variable to the phone object's `Price` property. If the conversion is not successful, line 42 displays an error message.

You might be wondering why we need the `price` variable in this code. Why not simply pass the `phone.Price` property as the second argument to the `decimal.TryParse` method in line 35? The reason is that the second argument passed to the `decimal.TryParse` method is passed to an out parameter. Recall that you cannot pass a property to a `ref` or an out parameter. So, we pass the `price` variable, and if the conversion is successful, we assign the `price` variable to the `phone.Price` property.

**Step 5:** Next you create the Click event handlers for the Button controls. Switch your view to the Form1 form in the Designer. Double-click the `createObjectButton` control. This opens the Form1.cs file in the code editor, and you will see an empty event handler named `createObjectButton_Click`. Complete the event handler by typing the code shown in lines 48–57 in Program 9-4. Let's review this code:

**Line 49:** This statement creates a `CellPhone` object in memory, referenced by a variable named `myPhone`.

**Line 52:** This statement calls the `GetPhoneData` method, passing the `myPhone` object as an argument.

**Lines 55–57:** These statements display the values of the `myPhone` object's `Brand`, `Model`, and `Price` properties in the `brandLabel`, `modelLabel`, and `priceLabel` controls.

**Step 6:** Switch your view back to the Form1 form in the *Designer* and double-click the `exitButton` control. In the code editor you will see an empty event handler named `exitButton_Click`. Complete the event handler by typing the code shown in lines 62–63 in Program 9-4.

**Step 7:** Save the project. Then, press `[F5]` on the keyboard or click the *Start Debugging* button (🐞) on the toolbar to compile and run the application. When the application runs, enter some sample data in the TextBox controls and click the *Create Object* button. You should see the values that you entered displayed in the `brandLabel`, `modelLabel`, and `priceLabel` controls. Click the *Exit* button when you are finished.

---

**Program 9-3** Completed code for the `CellPhone.cs` file in the *Cell Phone Test* application

```

1 using System;
2 using System.Collections.Generic;
3 using System.Linq;
4 using System.Text;
5 using System.Threading.Tasks;
6
7 namespace Cell_Phone_Test
8 {
9     class CellPhone
10    {
11        // Fields
12        private string _brand;    // The phone's brand

```

```

13     private string _model;    // The phone's model
14     private decimal _price;  // Retail price
15
16     // Constructor
17     public CellPhone()
18     {
19         _brand = "";
20         _model = "";
21         _price = 0m;
22     }
23
24     // Brand property
25     public string Brand
26     {
27         get { return _brand; }
28         set { _brand = value; }
29     }
30
31     // Model property
32     public string Model
33     {
34         get { return _model; }
35         set { _model = value; }
36     }
37
38     // Price property
39     public decimal Price
40     {
41         get { return _price; }
42         set { _price = value; }
43     }
44 }
45 }

```

---

**Program 9-4** Completed code for Form1 in the *Cell Phone Test* application

```

1  using System;
2  using System.Collections.Generic;
3  using System.ComponentModel;
4  using System.Data;
5  using System.Drawing;
6  using System.Linq;
7  using System.Text;
8  using System.Threading.Tasks;
9  using System.Windows.Forms;
10
11 namespace Cell_Phone_Test
12 {
13     public partial class Form1 : Form
14     {
15         public Form1()
16         {
17             InitializeComponent();
18         }
19
20         // The GetPhoneData method accepts a CellPhone object
21         // as an argument. It assigns the data entered by the
22         // user to the object's properties.
23         private void GetPhoneData(CellPhone phone)

```

```

24     {
25         // Temporary variable to hold the price.
26         decimal price;
27
28         // Get the phone's brand.
29         phone.Brand = brandTextBox.Text;
30
31         // Get the phone's model.
32         phone.Model = modelTextBox.Text;
33
34         // Get the phone's price.
35         if (decimal.TryParse(priceTextBox.Text, out price))
36         {
37             phone.Price = price;
38         }
39         else
40         {
41             // Display an error message.
42             MessageBox.Show("Invalid price");
43         }
44     }
45
46     private void createObjectButton_Click(object sender, EventArgs e)
47     {
48         // Create a CellPhone object.
49         CellPhone myPhone = new CellPhone();
50
51         // Get the phone data.
52         GetPhoneData(myPhone);
53
54         // Display the phone data.
55         brandLabel.Text = myPhone.Brand;
56         modelLabel.Text = myPhone.Model;
57         priceLabel.Text = myPhone.Price.ToString("c");
58     }
59
60     private void exitButton_Click(object sender, EventArgs e)
61     {
62         // Close the form.
63         this.Close();
64     }
65 }
66 }

```

## Read-Only Properties

Sometimes it is useful to make a property read only. A **read-only property** can be read, but it cannot be modified. If you need to make a property read only, you simply do not write a **set** accessor for the property. The following `Circle` class shows an example:

```

1 class Circle
2 {
3     // Field
4     private double _diameter;
5
6     // Constructor
7     public Circle()
8     {

```

```

 9         _diameter = 0.0;
10     }
11
12     // Diameter property
13     public double Diameter
14     {
15         get { return _diameter; }
16         set { _diameter = value; }
17     }
18
19     // Radius property (read-only)
20     public double Radius
21     {
22         get { return _diameter / 2; }
23     }
24 }

```

This class has two properties: Diameter (defined in lines 13–17) and Radius (defined in lines 20–23). Notice that the Radius property has a `get` accessor but does not have a `set` accessor. The Radius property is read only. Therefore, if we create an object of the `Circle` class, we can get the value of the Radius property, but an error will occur if we try to assign a value to the Radius property.

## Avoiding Stale Data

In the `Circle` class example, previously shown, notice that the Radius property does not have its own backing field, as the Diameter property does. Rather, the Radius property's `get` accessor returns the value of a calculation. The radius is not stored in a field because a circle's radius is dependent on the circle's diameter. If we store both the diameter and the radius in their own fields, the radius field will become incorrect as soon as the diameter field changes.

When a field's value is tightly dependent on other data and that field is not updated when the other data is changed, it is said that the field has become **stale**. When designing a class, you should take care not to store in a field any calculated data that can potentially become stale. Instead, provide a read-only property, or a method, that returns the value of the calculation.



### Checkpoint

- 9.6 What is a property?
- 9.7 When you pass a property as an argument to a method, there is one restriction. What is it?
- 9.8 How do you make a property read only?
- 9.9 What will happen if you try to assign a value to a read-only property?
- 9.10 What is stale data?

## 9.3

## Parameterized Constructors and Overloading

**CONCEPT:** A constructor that accepts arguments is known as a parameterized constructor. A class can have multiple versions of the same method, which are known as overloaded methods.

Constructors can accept arguments in the same way as other methods. A constructor that accepts arguments is known as a **parameterized constructor** because it has parameter variables. When a class has a parameterized constructor, you can pass initialization values to the constructor when you create an object. In Tutorial 9-3 you write a class that simulates a bank account. The class's constructor will accept an argument that specifies the account's starting balance.



### Tutorial 9-3: Creating and Using the BankAccount Class



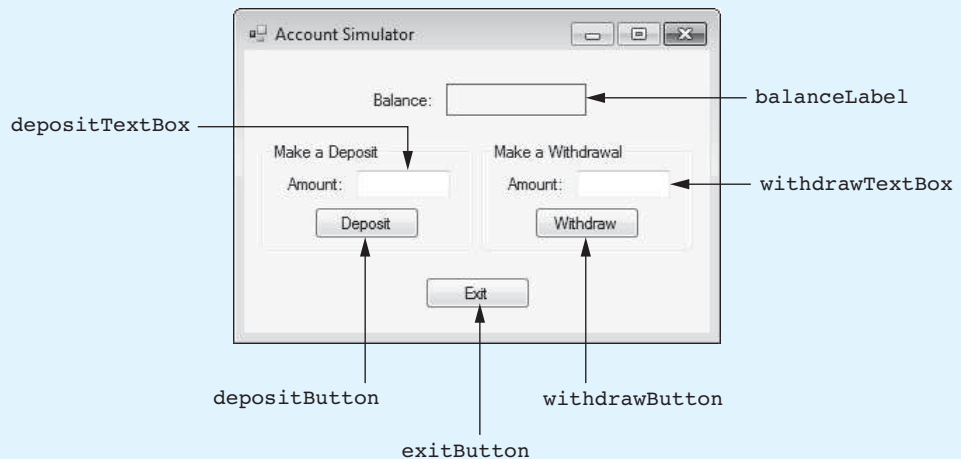
VideoNote

**Tutorial 9-3:**  
Creating and  
Using the  
BankAccount  
Class

In this tutorial you write a class named `BankAccount` that simulates a bank account. When you create an instance of the class, you pass the account's starting balance as an argument to the constructor. The class will have a `Deposit` method that adds an amount to the balance and a `Withdraw` method that subtracts an amount from the balance. The class will also have a read-only `Balance` property that reports the account's balance.

The `BankAccount` class is part of the *Account Simulator* application, which has already been started for you. Figure 9-15 shows the application's form. When the completed application runs, it creates a `BankAccount` object with a starting balance of \$1,000.00. The balance is displayed in the `balanceLabel` control. If you want to make a deposit, you can enter the amount into the `depositTextBox` and click the *Deposit* button. If you want to make a withdrawal, you can enter the amount into the `withdrawTextBox` and click the *Withdraw* button. Each time you perform one of these actions, the new account balance is displayed.

**Figure 9-15** The *Account Simulator* application's form



**Step 1:** Start Visual Studio (or Visual Studio Express). Open the project named *Account Simulator* in the *Chap09* folder of the Student Sample Programs.

**Step 2:** Click *PROJECT* on the Visual Studio menu bar and then select *Add Class....* The *Add New Item* window should appear. Make sure *Class* is selected as the type of item. Change the default filename to *BankAccount.cs* and then click the *Add* button. This adds a source code file named *BankAccount.cs* to the project.

**Step 3:** The `BankAccount.cs` file should now be displayed in the code editor. Complete the code for the `BankAccount` class by typing lines 11–36 in Program 9-5. Let's take a closer look at the code:

**Line 12:** This statement declares a private `decimal` field named `_balance`. The `_balance` field is the backing field for the `Balance` property.

**Lines 15–18:** These lines are the parameterized class constructor. When an instance of the class is created, an argument specifying the account's starting balance is passed into the `startingBalance` parameter. In line 17 the `startingBalance` parameter is assigned to the `_balance` field.

**Lines 21–24:** This is the code for the `Balance` property. Notice that the property does not have a `set` accessor, so it is read only.

**Lines 27–30:** This is the `Deposit` method, which accepts a `decimal` argument and adds the argument to the `_balance` field.

**Lines 33–36:** This is the `Withdraw` method, which accepts a `decimal` argument, and subtracts the argument from the `_balance` field.

**Step 4:** Open the `Form1.cs` file in the code editor. Type the comment and declaration shown in lines 15 and 16 of Program 9-6. The statement in line 16 does the following:

- It creates an object of the `BankAccount` class, passing the value 1000 as an argument to the constructor.
- It assigns a reference to the object to a field named `account`.

Because the `account` variable is declared as a field, all the methods in the `Form1` class have access to it.

**Step 5:** Next you create a `Load` event handler for the form. The `Load` event handler displays the account balance in the `balanceLabel` control. Switch your view to the `Form1` form in the *Designer* and double-click any part of the form that does not contain a control. This opens the code editor, and you will see an empty event handler named `Form1_Load`. Complete the event handler by typing the code shown in lines 25 and 26 in Program 9-6. Notice that line 26 uses the `ToString` method to format the `account` object's `Balance` property as currency and assigns the result to the `balanceLabel` control's `Text` property.

**Step 6:** Now you create the `Click` event handlers for the `Button` controls. Switch your view back to the `Form1` form in the *Designer* and double-click the `depositButton` control. This opens the code editor, and you will see an empty event handler named `depositButton_Click`. Complete the event handler by typing the code shown in lines 31–49 in Program 9-6. Let's look at the code:

**Line 31:** This statement declares a local `decimal` variable named `amount`. This holds the amount that the user wishes to deposit.

**Lines 34–49:** The `if` statement in line 34 calls the `decimal.TryParse` method to convert the `depositTextBox` control's `Text` property to a `decimal`, and it stores the result in the `amount` variable. If the conversion is successful, the following actions take place:

- Line 37 calls the `account` object's `Deposit` method, passing `amount` as an argument.
- Line 40 displays the account balance, formatted as currency.
- Line 43 clears the `depositTextBox` control.

If the conversion is not successful, line 48 displays an error message.

**Step 7:** Switch your view back to the Form1 form in the *Designer* and double-click the `withdrawButton` control. This opens the code editor, and you will see an empty event handler named `withdrawButton_Click`. Complete the event handler by typing the code shown in lines 54–72 in Program 9-6. Let’s look at the code:

**Line 54:** This statement declares a local `decimal` variable named `amount`. This holds the amount that the user wishes to withdraw.

**Lines 57–72:** The `if` statement in line 57 calls the `decimal.TryParse` method to convert the `withdrawTextBox` control’s `Text` property to a `decimal`, and it stores the result in the `amount` variable. If the conversion is successful, the following actions take place:

- Line 60 calls the `account` object’s `Withdraw` method, passing `amount` as an argument.
- Line 63 displays the account balance, formatted as currency.
- Line 66 clears the `withdrawTextBox` control.

If the conversion is not successful, line 71 displays an error message.

**Step 8:** Switch your view back to the Form1 form in the *Designer* and double-click the `exitButton` control. In the code editor you will see an empty event handler named `exitButton_Click`. Complete the event handler by typing the code shown in lines 77–78 in Program 9-6.

**Step 9:** Save the project. Then, press `F5` on the keyboard or click the *Start Debugging* button (🐞) on the toolbar to compile and run the application. When the application runs, experiment by depositing and withdrawing various amounts. Click the *Exit* button when you are finished.

---

**Program 9-5** Completed code for the `BankAccount.cs` file in the *Account Simulator* application

```

1 using System;
2 using System.Collections.Generic;
3 using System.Linq;
4 using System.Text;
5 using System.Threading.Tasks;
6
7 namespace Account_Simulator
8 {
9     class BankAccount
10    {
11        // Field
12        private decimal _balance;
13
14        // Constructor
15        public BankAccount(decimal startingBalance)
16        {
17            _balance = startingBalance;
18        }
19
20        // Balance property (read-only)
21        public decimal Balance
22        {
23            get { return _balance; }
24        }
25
26        // Deposit method

```

```
27     public void Deposit(decimal amount)
28     {
29         _balance += amount;
30     }
31
32     // Withdraw method
33     public void Withdraw(decimal amount)
34     {
35         _balance -= amount;
36     }
37 }
38 }
```

---

**Program 9-6** Completed code for Form1 in the *Account Simulator* application

```
1 using System;
2 using System.Collections.Generic;
3 using System.ComponentModel;
4 using System.Data;
5 using System.Drawing;
6 using System.Linq;
7 using System.Text;
8 using System.Threading.Tasks;
9 using System.Windows.Forms;
10
11 namespace Account_Simulator
12 {
13     public partial class Form1 : Form
14     {
15         // BankAccount field with a $1000 starting balance
16         private BankAccount account = new BankAccount(1000);
17
18         public Form1()
19         {
20             InitializeComponent();
21         }
22
23         private void Form1_Load(object sender, EventArgs e)
24         {
25             // Display the starting balance.
26             balanceLabel.Text = account.Balance.ToString("c");
27         }
28
29         private void depositButton_Click(object sender, EventArgs e)
30         {
31             decimal amount; // To hold the amount of deposit
32
33             // Convert the amount to a decimal.
34             if (decimal.TryParse(depositTextBox.Text, out amount))
35             {
36                 // Deposit the amount into the account.
37                 account.Deposit(amount);
38
39                 // Display the new balance.
40                 balanceLabel.Text = account.Balance.ToString("c");
41
42                 // Clear the text box.
43                 depositTextBox.Clear();
44             }
45         }
46     }
47 }
```



```

45         else
46         {
47             // Display an error message.
48             MessageBox.Show("Invalid amount");
49         }
50     }
51
52     private void withdrawButton_Click(object sender, EventArgs e)
53     {
54         decimal amount; // To hold the amount of withdrawal
55
56         // Convert the amount to a decimal.
57         if (decimal.TryParse(withdrawTextBox.Text, out amount))
58         {
59             // Withdraw the amount from the account.
60             account.Withdraw(amount);
61
62             // Display the new balance.
63             balanceLabel.Text = account.Balance.ToString("c");
64
65             // Clear the text box.
66             withdrawTextBox.Clear();
67         }
68         else
69         {
70             // Display an error message.
71             MessageBox.Show("Invalid amount");
72         }
73     }
74
75     private void exitButton_Click(object sender, EventArgs e)
76     {
77         // Close the form.
78         this.Close();
79     }
80 }
81 }

```

## Overloaded Methods

Sometimes you need different ways to perform the same operation. For example, the `BankAccount` class that you wrote in Tutorial 9-3 has a `Deposit` method that accepts a `decimal` argument. Suppose you are using the class in an application that needs to pass a `double` variable to the method instead of a `decimal` variable. In this application, before you call the `Deposit` method, you have to convert the `double` variable to a `decimal` so it can be passed to the method. It would be nice if the `Deposit` method could accept either a `decimal` argument or a `double` argument. Then, it would be unnecessary to convert a `double` variable before passing it to the method. This can be accomplished with overloading.

When a method is **overloaded**, it means that multiple methods in the same class have the same name but use different types of parameters. Here is an example of how we might overload the `Deposit` method inside the `BankAccount` class:

```

1 // Deposit method
2 public void Deposit(decimal amount)
3 {
4     _balance += amount;
5 }

```

```

6
7 // Deposit method
8 public void Deposit(double amount)
9 {
10     _balance += (decimal)amount;
11 }

```

The first `Deposit` method (in lines 2–5) accepts a `decimal` argument, which is added to the `_balance` field in line 4. The second `Deposit` method (in lines 8–11) accepts a `double` argument. Line 10 uses a cast operator to convert its value to a `decimal`, and assigns the result to the `_balance` field.

When you write a call to the `Deposit` method, the compiler must determine which one of the overloaded methods you intended to call. The process of matching a method call with the correct method is known as **binding**. When an overloaded method is called, the compiler uses the method’s name and parameter list to determine to which method to bind the call. If we call the `Deposit` method and pass a `decimal` argument, the version of the method that has a `decimal` parameter is called. Likewise, if we call the `Deposit` method and pass a `double` argument, the version of the method that has a `double` parameter is called.

The compiler uses a method’s signature to distinguish it from other methods of the same name. A method’s **signature** consists of the method’s name and the data type and argument kind (by value, `ref`, or `out`) of the method’s parameters, from left to right. For example, here are the signatures of the `Deposit` methods that we previously showed:

```

Deposit(decimal)
Deposit(double)

```

Note that the method’s return type is *not* part of the signature. For this reason, you cannot overload methods by giving them different return types.

## Overloaded Constructors

Constructors can also be overloaded, which means that a class can have more than one constructor. The rules for overloading constructors are the same for overloading other methods: Each version of the constructor must have a different parameter list. As long as each constructor has a unique signature, the compiler can tell them apart.

Here is an example of how we might overload the `BankAccount` class constructor:

```

1 // Constructor
2 public BankAccount()
3 {
4     _balance = 0;
5 }
6
7 // Constructor
8 public BankAccount(decimal startingBalance)
9 {
10     _balance = startingBalance;
11 }

```

The first constructor (lines 2–5) is a **parameterless constructor**, which means it accepts no arguments. The following statement calls the parameterless constructor as it creates a `BankAccount` object:

```
BankAccount account = new BankAccount();
```

The second constructor (lines 8–11) accepts a `decimal` argument. The following statement calls this constructor as it creates a `BankAccount` object:

```
BankAccount account = new BankAccount(500m);
```

The following statement also calls the second constructor (lines 8–11) because an integer value can be implicitly converted to a decimal:

```
BankAccount account = new BankAccount(500);
```

The following code will cause an error, however, because there is no constructor that accepts a double argument:

```
// Error
BankAccount account = new BankAccount(500.0);
```

## Default Constructors

It is perfectly legal to write a class without any constructors. If you write a class with no constructor whatsoever, the compiler provides a default constructor. The **default constructor** is a parameterless constructor (it accepts no arguments), and it initializes the object's fields with the value 0. (If any fields are reference variables, they are initialized with the special value `null`.)



### Checkpoint

- 9.11 What is a parameterized constructor?
- 9.12 What does it mean when a method is overloaded?
- 9.13 What is the process of matching a method call with the correct method called?
- 9.14 What happens if you write a class with no constructor whatsoever?
- 9.15 Describe the purpose of the default constructor.

## 9.4

## Storing Class Type Objects in Arrays and Lists

**CONCEPT:** You can store a collection of class type objects in an array or a **List**.

### Arrays of Class Type Objects

Objects that are instances of a class can be stored in an array. For example, assume the `CellPhone` class previously shown exists in an application. The following code creates a `CellPhone` array with four elements:

```
const int SIZE = 4;
CellPhone[] phones = new CellPhone[SIZE];
```

Although this code creates an array, it does not yet contain any objects. When you create an array of a class type, each element of the array is a reference variable. By default, each element will be initialized with the value `null`. The next step is to create the objects that each element will reference. This can be done one element at a time, as shown here:

```
phones[0] = new CellPhone();
phones[1] = new CellPhone();
phones[2] = new CellPhone();
phones[3] = new CellPhone();
```

Or, it can be done with a loop, as shown here:

```
for (int index = 0; index < phones.Length; index++)
{
```

```
phones[index] = new CellPhone();
}
```

Alternatively, you can initialize the array elements in the declaration statement:

```
CellPhone[] phones = {
    new CellPhone(), new CellPhone(),
    new CellPhone(), new CellPhone()
};
```

The following shows another example. This code creates a `BankAccount` array and initializes its elements with references to four `BankAccount` objects.

```
BankAccount[] accounts = {
    new BankAccount(1000),
    new BankAccount(2000),
    new BankAccount(3000),
    new BankAccount(4000)
};
```

Notice the arguments that are passed to the `BankAccount` constructor for each object. If the following code were executed, it would display “The balance is 1000”, “The balance is 2000”, and so forth:

```
for (int index = 0; index < accounts.Length; index++)
{
    MessageBox.Show("The balance is " +
        accounts[index].Balance);
}
```

The following code performs the same operation using a `foreach` loop:

```
foreach (BankAccount acct in accounts)
{
    MessageBox.Show("The balance is " +
        acct[index].Balance);
}
```

## Lists of Class Type Objects

In Chapter 7 we discussed the `List` class, which is a container for storing a collection of objects. Here is an example of how you would create a `List` that can hold `CellPhone` objects:

```
List<CellPhone> phoneList = new List<CellPhone>();
```

This statement creates a `List` object, referenced by the `phoneList` variable. Notice that the word `CellPhone` is written inside angled brackets, `<>`, immediately after the word `List`. This specifies that the `List` can hold only objects of the `CellPhone` class type.

To add an object to a `List`, you use the `Add` method. The following code shows an example:

```
1 // Create a List to hold CellPhone objects.
2 List<CellPhone> phoneList = new List<CellPhone>();
3
4 // Create an instance of the CellPhone class.
5 CellPhone myPhone = new CellPhone();
6
7 // Assign values to the object's properties.
8 myPhone.Brand = "Acme Electronics";
9 myPhone.Model = "M1000";
10 myPhone.Price = 199;
11
12 // Add the object to the List.
13 phoneList.Add(myPhone);
```

The statement in line 2 creates a `List` named `phoneList` that can hold `CellPhone` objects. Line 5 creates an instance of the `CellPhone` class, referenced by the `myPhone` variable. Lines 8–10 assign values to the object’s properties. Line 13 adds the object to the `List`.

In Tutorial 9-4 you complete an application that uses a `List` to hold a collection of `CellPhone` objects.



VideoNote

**Tutorial 9-4:**  
Completing the *Cell Phone Inventory* Application



### Tutorial 9-4: Completing the *Cell Phone Inventory* Application

In this tutorial you complete the *Cell Phone Inventory* application. Figure 9-16 shows the application’s form, which has already been created for you. When you run the completed application, you can enter data about a cell phone into the `TextBox` controls. When you click the *Add Phone* button, that data is assigned to a `CellPhone` object’s properties and then the object is added to a `List`. You can do this as many times as you wish. Each time you add a cell phone, its brand and model is displayed in the list box. If you select a phone in the list box, the application displays that phone’s price.

**Figure 9-16** The *Cell Phone Inventory* application’s form

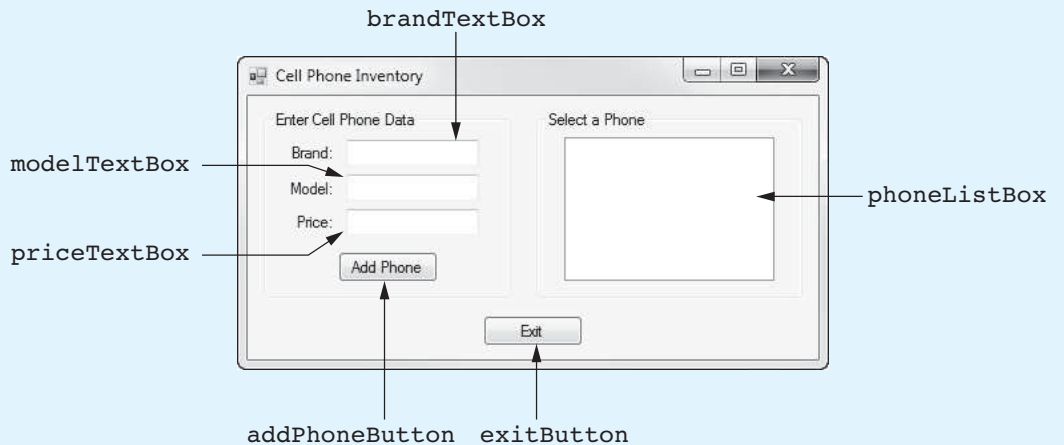
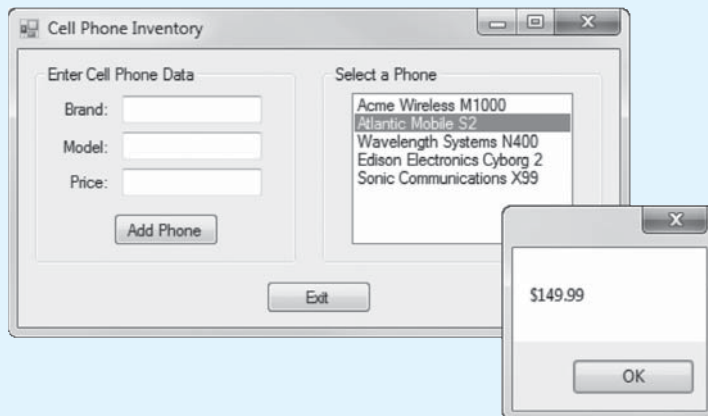


Figure 9-17 shows an example of the application at run time. In the figure, five cell phones have been added, and *Atlantic Mobile S2* has been selected in the list box. The selected phone’s price is displayed in the message box.

**Figure 9-17** The *Cell Phone Inventory* application running



**Step 1:** Start Visual Studio (or Visual Studio Express). Open the project named *Cell Phone Inventory* in the *Chap09* folder of the Student Sample Programs. Notice that the `CellPhone` class has already been added to the project for you in the file `CellPhone.cs`.

**Step 2:** Open the `Form1.cs` file in the code editor. Write the comment and the declaration for `phoneList`, which appears in lines 15 and 16 in Program 9-7. Notice that `phoneList` is declared as a field in the `Form1` class. It will be available to all the methods in the class.

**Step 3:** Type the comments and code for the `GetPhoneData` method, shown in lines 23–47 of Program 9-7. Notice that the method accepts a `CellPhone` object as an argument. The purpose of the `GetPhoneData` method is to read the data that the user has entered into the form’s text boxes and store that data in the argument object’s properties. (This method might look familiar. We used it in Tutorial 9-2.)

**Step 4:** Switch your view to the `Form1` form in the *Designer* and double-click the `addPhoneButton` control. This opens the code editor, and you will see an empty event handler named `addPhoneButton_Click`. Complete the event handler by typing the code shown in lines 51–70 in Program 9-7. Let’s look at the code:

**Line 52:** This statement creates a `CellPhone` object in memory, referenced by a variable named `myPhone`.

**Line 55:** This statement calls the `GetPhoneData` method, passing the `myPhone` object as an argument. After the method executes, the `myPhone` object’s properties are set to the data entered by the user.

**Line 58:** This statement adds the `myPhone` object to the `phoneList`.

**Lines 61–62:** These statements add an entry to the `phoneListBox` control displaying the `myPhone` object’s `Brand` and `Model` properties.

**Lines 65–67:** These statements clear the contents of the `TextBox` controls.

**Line 70:** This statement sets the focus to the `brandTextBox` control.

Note that each `CellPhone` object that is added to the `phoneList` has a corresponding item in the `ListBox` control. An object in the `phoneList` and its corresponding item in the `ListBox` share the same index. For example,

- The `CellPhone` object at index 0 in `phoneList` corresponds to the item at index 0 in the `ListBox`.
- The `CellPhone` object at index 1 in `phoneList` corresponds to the item at index 1 in the `ListBox`.

Recall from Chapter 8 that when the items in two data structures are related by their indexes, it is said that a parallel relationship exists between the data structures.

**Step 5:** Next you create the `SelectedIndexChanged` event handler for the `phoneListBox` control. Switch back to the *Designer* and double-click the `phoneListBox` control. This opens the code editor, and you will see an empty event handler named `phoneListBox_SelectedIndexChanged`. Complete the event handler by typing the code shown in lines 75–79 in Program 9-7.

We mentioned in Step 4 that the items in the list box and the objects in the `phoneList` are related by their indexes. When the user selects an item from the list box, all we have to do is get that item’s index and then use that same index to retrieve the corresponding object from the `phoneList`. That is exactly what happens in this event handler. Line 76 gets the index of the selected item in the `phoneListBox` control and assigns it to the `index` variable. Line 79 uses the

index variable to get an object from `phoneList` and display its `Price` property in a message box.

- Step 6:** Switch your view back to the *Designer* and double-click the `exitButton` control. In the code editor you will see an empty event handler named `exitButton_Click`. Complete the event handler by typing the code shown in lines 84 and 85 in Program 9-7.
- Step 7:** Save the project. Then, press **F5** on the keyboard or click the *Start Debugging* button (🐞) on the toolbar to compile and run the application. When the application runs, enter some sample data in the `TextBox` controls and click the *Add Phone* button. Repeat this with several different sets of data. Each time you add a phone, you should see its brand and model displayed in the list box. After you have entered data for several phones, click the entries that appear in the list box to see each phone's price. Click the *Exit* button when you are finished.

---

**Program 9-7** Completed code for `Form1` in the *Cell Phone Inventory* application

```

1 using System;
2 using System.Collections.Generic;
3 using System.ComponentModel;
4 using System.Data;
5 using System.Drawing;
6 using System.Linq;
7 using System.Text;
8 using System.Threading.Tasks;
9 using System.Windows.Forms;
10
11 namespace Cell_Phone_Inventory
12 {
13     public partial class Form1 : Form
14     {
15         // List to hold CellPhone objects
16         List<CellPhone> phoneList = new List<CellPhone>();
17
18         public Form1()
19         {
20             InitializeComponent();
21         }
22
23         // The GetPhoneData method accepts a CellPhone object
24         // as an argument. It assigns the data entered by the
25         // user to the object's properties.
26         private void GetPhoneData(CellPhone phone)
27         {
28             // Temporary variable to hold the price.
29             decimal price;
30
31             // Get the phone's brand.
32             phone.Brand = brandTextBox.Text;
33
34             // Get the phone's model.
35             phone.Model = modelTextBox.Text;
36
37             // Get the phone's price.
38             if (decimal.TryParse(priceTextBox.Text, out price))
39             {
40                 phone.Price = price;

```

```
41         }
42     else
43     {
44         // Display an error message.
45         MessageBox.Show("Invalid price");
46     }
47 }
48
49 private void addPhoneButton_Click(object sender, EventArgs e)
50 {
51     // Create a CellPhone object.
52     CellPhone myPhone = new CellPhone();
53
54     // Get the phone data.
55     GetPhoneData(myPhone);
56
57     // Add the CellPhone object to the List.
58     phoneList.Add(myPhone);
59
60     // Add an entry to the list box.
61     phoneListBox.Items.Add(myPhone.Brand + " " +
62                           myPhone.Model);
63
64     // Clear the TextBox controls.
65     brandTextBox.Clear();
66     modelTextBox.Clear();
67     priceTextBox.Clear();
68
69     // Reset the focus.
70     brandTextBox.Focus();
71 }
72
73 private void phoneListBox_SelectedIndexChanged(object sender, EventArgs e)
74 {
75     // Get the index of the selected item.
76     int index = phoneListBox.SelectedIndex;
77
78     // Display the selected item's price.
79     MessageBox.Show(phoneList[index].Price.ToString("c"));
80 }
81
82 private void exitButton_Click(object sender, EventArgs e)
83 {
84     // Close the form.
85     this.Close();
86 }
87 }
88 }
```



## Checkpoint

- 9.16 When you create an array of a class type, with what value will each element of the array be initialized?
- 9.17 How can you initialize an array of a class type with references to objects of the class?
- 9.18 How do you specify the class type that a List can hold?



## 9.5 Finding the Classes and Their Responsibilities in a Problem

When developing an object-oriented program, one of your first tasks is to identify the classes that you will need to create. Typically, your goal is to identify the different types of real-world objects that are present in the problem and then create classes for those types of objects within your application.

Over the years, software professionals have developed numerous techniques for finding the classes in a given problem. One simple and popular technique involves the following steps.

1. Get a written description of the problem domain.
2. Identify all the nouns (including pronouns and noun phrases) in the description. Each of these is a potential class.
3. Refine the list to include only the classes that are relevant to the problem.

Let's take a closer look at each of these steps.

### Writing a Description of the Problem Domain

The **problem domain** is the set of real-world objects, parties, and major events related to the problem. If you adequately understand the nature of the problem you are trying to solve, you can write a description of the problem domain yourself. If you do not thoroughly understand the nature of the problem, you should have an expert write the description for you.

For example, suppose we are programming an application that the manager of Joe's Automotive Shop will use to print service quotes for customers. Here is a description that an expert, perhaps Joe himself, might have written:

Joe's Automotive Shop services foreign cars and specializes in servicing cars made by Mercedes, Porsche, and BMW. When a customer brings a car to the shop, the manager gets the customer's name, address, and telephone number. The manager then determines the make, model, and year of the car and gives the customer a service quote. The service quote shows the estimated parts charges, estimated labor charges, sales tax, and total estimated charges.

The problem domain description should include any of the following:

- Physical objects such vehicles, machines, or products
- Any role played by a person, such as manager, employee, customer, teacher, student, and so on
- The results of a business event, such as a customer order or, in this case, a service quote
- Record-keeping items, such as customer histories and payroll records

### Identify All of the Nouns

The next step is to identify all of the nouns and noun phrases. (If the description contains pronouns, include them, too.) Here's another look at the previous problem domain description. This time the nouns and noun phrases appear in bold.

**Joe's Automotive Shop** services **foreign cars** and specializes in servicing **cars** made by **Mercedes, Porsche, and BMW**. When a **customer** brings a **car** to the **shop**, the **manager** gets the **customer's name, address, and telephone number**. The **manager** then determines the **make, model, and year** of the **car** and gives the **customer** a **service quote**. The **service quote** shows the **estimated parts charges, estimated labor charges, sales tax, and total estimated charges**.

Notice that some of the nouns are repeated. The following list shows all the nouns without duplicating any of them.

address  
BMW  
car  
cars  
customer  
estimated labor charges  
estimated parts charges  
foreign cars  
Joe's Automotive Shop  
make  
manager  
Mercedes  
model  
name  
Porsche  
sales tax  
service quote  
shop  
telephone number  
total estimated charges  
year

## Refining the List of Nouns

The nouns that appear in the problem description are merely candidates to become classes. It might not be necessary to make classes for them all. The next step is to refine the list to include only the classes that are necessary to solve the particular problem at hand. We look at the common reasons that a noun can be eliminated from the list of potential classes.

### 1. Some of the nouns really mean the same thing.

In this example, the following sets of nouns refer to the same thing:

- **car**, **cars**, and **foreign cars**

These all refer to the general concept of a car.

- **Joe's Automotive Shop** and **shop**

Both of these refer to the company "Joe's Automotive Shop."

We can settle on a single class for each of these. In this example we arbitrarily eliminate **cars** and **foreign cars** from the list and use the word **car**. Likewise, we eliminate **Joe's Automotive Shop** from the list and use the word **shop**. The updated list of potential classes is as follows:

address  
BMW  
car  
~~cars~~

customer  
 estimated labor charges  
 estimated parts charges  
~~foreign cars~~  
~~Joe's Automotive Shop~~  
 make  
 manager  
 Mercedes  
 model  
 name  
 Porsche  
 sales tax  
 service quote  
 shop  
 telephone number  
 total estimated charges  
 year

Because **car**, **cars**, and **foreign cars** mean the same thing in this problem, we have eliminated **cars** and **foreign cars**. Also, because **Joe's Automotive Shop** and **shop** mean the same thing, we have eliminated **Joe's Automotive Shop**.

**2. Some nouns might represent items that we do not need to be concerned with in order to solve the problem.**

A quick review of the problem description reminds us of what our application should do: print a service quote. In this example we can eliminate two unnecessary classes from the list:

- We can cross **shop** off the list because our application needs to be concerned only with individual service quotes. It does not need to work with or determine any companywide information. If the problem description asked us to keep a total of all the service quotes, then it would make sense to have a class for the shop.
- We will not need a class for the **manager** because the problem statement does not direct us to process any information about the manager. If there were multiple shop managers, and the problem description had asked us to record which manager generated each service quote, then it would make sense to have a class for the manager.

The updated list of potential classes at this point is as follows:

address  
 BMW  
~~car~~  
~~cars~~  
 customer  
 estimated labor charges  
 estimated parts charges  
~~foreign cars~~  
~~Joe's Automotive Shop~~  
 make  
~~manager~~  
 Mercedes  
 model  
 name

Our problem description does not direct us to process any information about the **shop** or any information about the **manager**, so we have eliminated those from the list.

Porsche  
 sales tax  
 service quote  
~~shop~~  
 telephone number  
 total estimated charges  
 year

3. Some of the nouns might represent objects, not classes.

We can eliminate **Mercedes**, **Porsche**, and **BMW** as classes because, in this example, they all represent specific cars and can be considered instances of a **car** class. At this point the updated list of potential classes is as follows:

address  
~~BMW~~  
 car  
~~cars~~  
 customer  
 estimated labor charges  
 estimated parts charges  
~~foreign cars~~  
~~Joe's Automotive Shop~~  
~~manager~~  
 make  
~~Mercedes~~  
 model  
 name  
~~Porsche~~  
 sales tax  
 service quote  
~~shop~~  
 telephone number  
 total estimated charges  
 year

We have eliminated **Mercedes**, **Porsche**, and **BMW**, because they are all instances of a **car** class. That means that these nouns identify objects, not classes.

4. Some of the nouns might represent simple values that can be assigned to a variable and do not require a class.



**NOTE:** Some object-oriented designers take note of whether a noun is plural or singular. Sometimes a plural noun will indicate a class and a singular noun will indicate an object.

A class contains data attributes and methods. Data attributes are the fields and properties that define the object's state. Methods are actions or behaviors that can be performed by an object of the class. If a noun represents a type of item that would not have any identifiable data attributes or methods, then it can probably be eliminated from the list. To help determine whether a noun represents an

item that would have data attributes and methods, ask the following questions about it:

- Would you use a group of related values to represent the item's state?
- Are there any obvious actions to be performed by the item?

If the answers to both of these questions are no, then the noun probably represents a value that can be stored in a simple variable. If we apply this test to each noun that remains in our list, we can conclude that the following are probably not classes: **address**, **estimated labor charges**, **estimated parts charges**, **make**, **model**, **name**, **sales tax**, **telephone number**, **total estimated charges**, and **year**. These are all simple string or numeric values that can be stored in variables. Here is the updated list of potential classes:

~~address~~  
~~BMW~~  
~~car~~  
~~cars~~  
~~customer~~  
~~estimated labor charges~~  
~~estimated parts charges~~  
~~foreign cars~~  
~~Joe's Automotive Shop~~  
~~make~~  
~~manager~~  
~~Mercedes~~  
~~model~~  
~~name~~  
~~Porsche~~  
~~sales tax~~  
~~service quote~~  
~~shop~~  
~~telephone number~~  
~~total estimated charges~~  
~~year~~

We have eliminated **address**, **estimated labor charges**, **estimated parts charges**, **make**, **model**, **name**, **sales tax**, **telephone number**, **total estimated charges**, and **year** as classes because they represent simple values that can be stored in variables.

As you can see from the list, we have eliminated everything except **car**, **customer**, and **service quote**. This means that in our application, we need classes to represent cars, customers, and service quotes. Ultimately, we will write a `Car` class, a `Customer` class, and a `ServiceQuote` class.

## Identifying a Class's Responsibilities

Once the classes have been identified, the next task is to identify each class's responsibilities. A class's *responsibilities* are as follows:

- The things that the class is responsible for knowing
- The actions that the class is responsible for doing

When you have identified the things that a class is responsible for knowing, then you have identified the class's fields and/or properties. Likewise, when you have identified the actions that a class is responsible for doing, you have identified its methods.

It is often helpful to ask these questions: In the context of this problem, what must the class know? What must the class do? The first place to look for the answers is in the description of the problem domain. Many of the things that a class must know and do will be mentioned. Some class responsibilities, however, might not be directly mentioned in

the problem domain, so brainstorming is often required. Let's apply this methodology to the classes we previously identified from our problem domain.

### The Customer class

In the context of our problem domain, what must the `Customer` class know? The description directly mentions the following items:

- The customer's name
- The customer's address
- The customer's telephone number

These are all values that can be represented as strings and stored as properties. The `Customer` class can potentially know many other things. One mistake that can be made at this point is to identify too many things that an object is responsible for knowing. In some applications, a `Customer` class might know the customer's e-mail address. This particular problem domain does not mention that the customer's e-mail address is used for any purpose, so we should not include it as a responsibility.

Now let's identify the class's methods. In the context of our problem domain, what must the `Customer` class do? The only obvious actions are these:

- Create and initialize an object of the `Customer` class.
- Get and set the customer's name.
- Get and set the customer's address.
- Get and set the customer's telephone number.

From this list we can see that the `Customer` class will have a constructor as well as fields and properties for the data attributes. The following code shows how the `Customer` class might be written:

```
1 class Customer
2 {
3     // Fields
4     private string _name;
5     private string _address;
6     private string _phone;
7
8     // Constructor
9     public Customer(string name, string address, string phone)
10    {
11        _name = name;
12        _address = address;
13        _phone = phone;
14    }
15
16    // Name property
17    public string Name
18    {
19        get { return _name; }
20        set { _name = value; }
21    }
22
23    // Address property
24    public string Address
25    {
26        get { return _address; }
27        set { _address = value; }
28    }
29
30    // Phone property
31    public string Phone
32    {
```

```

33         get { return _phone; }
34         set { _phone = value; }
35     }
36 }

```

### The car Class

In the context of our problem domain, what must an object of the Car class know? The following items are all data attributes of a car and are mentioned in the problem domain:

- The car's make
- The car's model
- The car's year

Now let's identify the class's methods. In the context of our problem domain, what must the car class do? Once again, the only obvious actions are the standard set of methods that we will find in most classes. Specifically, the actions are these:

- Create and initialize an object of the Car class.
- Get and set the car's make.
- Get and set the car's model.
- Get and set the car's year.

The following code shows how the Car class might be written:

```

1 class Car
2 {
3     // Fields
4     private string _make;
5     private string _model;
6     private int _year;
7
8     // Constructor
9     public Car(string make, string model, int year)
10    {
11        _make = make;
12        _model = model;
13        _year = year;
14    }
15
16    // Make property
17    public string Make
18    {
19        get { return _make; }
20        set { _make = value; }
21    }
22
23    // Model property
24    public string Model
25    {
26        get { return _model; }
27        set { _model = value; }
28    }
29
30    // Year property
31    public int Year
32    {
33        get { return _year; }
34        set { _year = value; }
35    }
36 }

```

### The ServiceQuote Class

In the context of our problem domain, what must an object of the `ServiceQuote` class know? The problem domain mentions the following items:

- The estimated parts charges
- The estimated labor charges
- The sales tax
- The total estimated charges

Careful thought and a little brainstorming reveals that two of these items are the results of calculations: sales tax and total estimated charges. Furthermore, in order to calculate the sales tax, the class must also know the sales tax rate.

Now let's identify the class's methods. In the context of our problem domain, what must the `ServiceQuote` class do? Once again, the only obvious actions are the standard set of methods that we will find in most classes. Specifically, the actions are these:

- Create and initialize an object of the `ServiceQuote` class.
- Get and set the estimated parts charges.
- Get and set the estimated labor charges.
- Get and set the sales tax rate.
- Get the sales tax.
- Get the total estimated charges.

The following code shows how the `ServiceQuote` class might be written:

```
1 class ServiceQuote
2 {
3     // Fields
4     private decimal _partsCharges;
5     private decimal _laborCharges;
6     private decimal _taxRate;
7
8     // Constructor
9     public ServiceQuote(decimal partsCharges,
10         decimal laborCharges, decimal taxRate)
11     {
12         _partsCharges = partsCharges;
13         _laborCharges = laborCharges;
14         _taxRate = taxRate;
15     }
16
17     // PartsCharges property
18     public decimal PartsCharges
19     {
20         get { return _partsCharges; }
21         set { _partsCharges = value; }
22     }
23
24     // LaborCharges property
25     public decimal LaborCharges
26     {
27         get { return _laborCharges; }
28         set { _laborCharges = value; }
29     }
30
31     // TaxRate property
32     public decimal TaxRate
33     {
34         get { return _taxRate; }
35         set { _taxRate = value; }
36     }
```



```

37
38 // SalesTax property (read-only)
39 public decimal SalesTax
40 {
41     get { return _partsCharges * _taxRate; }
42 }
43
44 // TotalCharges property (read-only)
45 public decimal TotalCharges
46 {
47     get
48     {
49         return _partsCharges + _laborCharges +
50             (_partsCharges * _taxRate);
51     }
52 }
53 }

```

## This Is Only the Beginning

You should look at the process that we have discussed in this section merely as a starting point. It's important to realize that designing an object-oriented application is an iterative process. It may take you several attempts to identify all the classes that you will need and determine all their responsibilities. As the design process unfolds, you will gain a deeper understanding of the problem, and consequently you will see ways to improve the design.



### Checkpoint

- 9.19 What is a problem domain?
- 9.20 When designing an object-oriented application, who should write a description of the problem domain?
- 9.21 How do you identify the potential classes in a problem domain description?
- 9.22 What are a class's responsibilities?
- 9.23 What two questions should you ask to determine a class's responsibilities?
- 9.24 Will all a class's actions always be directly mentioned in the problem domain description?

## 9.6

## Creating Multiple Forms in a Project

**CONCEPT:** A Visual C# project can have multiple forms. Each form has its own class that can be instantiated and displayed on the screen.

The applications you have created so far have used only one form, named Form1. The Form1 form is displayed when the application runs, and when the Form1 form closes, the application ends. You are not limited to one form in a project, however. You may create multiple forms in a project to use as dialog boxes, to display error messages, and so on. Then you can display these forms as they are needed.

Every form in a Visual C# project has a class. For example, if a project has a form named Form1, then the project has a class named `Form1`, which is stored in a file named `Form1.cs`. When you add additional forms to a project, you add additional classes, which are stored in their own files. When you create event handlers for a specific form's controls, you write them as methods in that form's class.

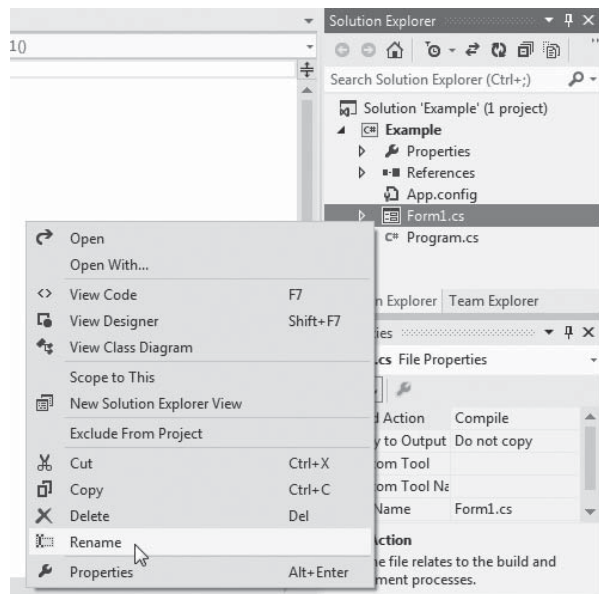
## Renaming the Form1 Form

When you add forms to a Visual C# project, they are given default names such as Form1, Form2, and so on. If you have only one form in a project, there is no compelling reason to change the form's name. However, when you have multiple forms in a project, you should give each form a meaningful name that describes its purpose.

Before you add a new form to a project, it is a good idea to change the name of the Form1 form. In this book, we always change the name of the Form1 form to MainForm because it is usually the main form in an application. To change the form's name, you use the *Solution Explorer* to change the name of the Form1.cs file to MainForm.cs. When you do this, Visual Studio automatically changes the name of the Form1 form to MainForm. Here is the procedure to follow:

1. Right-click the Form1.cs entry that appears in the *Solution Explorer*. The pop-up menu shown in Figure 9-18 should appear.

**Figure 9-18** Right-clicking the form file in the *Solution Explorer*



2. Select *Rename* from the pop-up menu.
3. In the *Solution Explorer*, the form's filename should become highlighted. Type the new name, which is *MainForm.cs*, and press **Enter**. (Be sure to type the *.cs* extension.)
4. The dialog box shown in Figure 9-19 will appear next. Click *Yes* to rename the form.

**Figure 9-19** Clicking *Yes* to rename the form

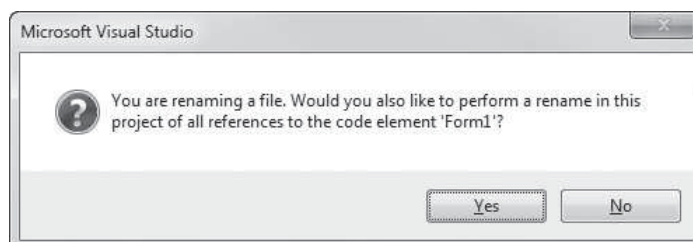
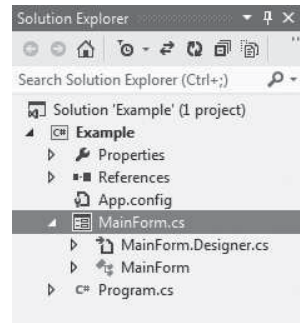


Figure 9-20 shows an example of the Solution Explorer after the `Form1.cs` file has been renamed `MainForm.cs`.

**Figure 9-20** Form file renamed as `MainForm.cs`

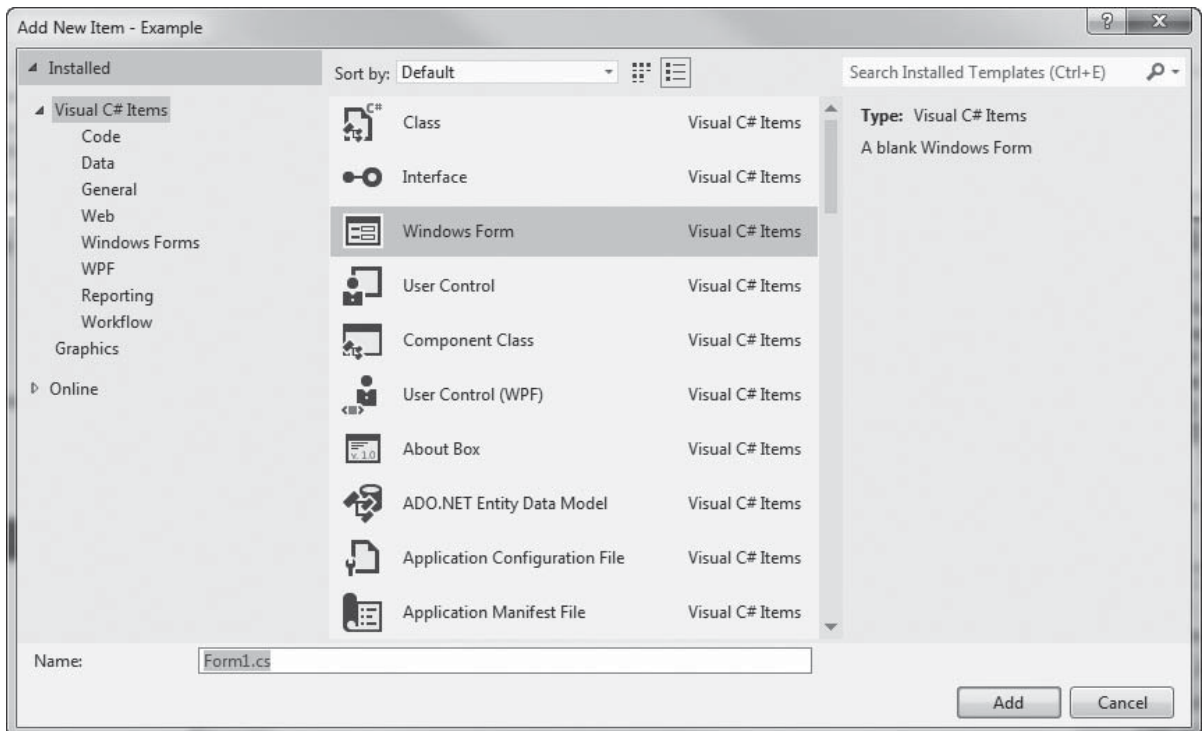


## Adding a New Form to a Project

Follow these steps to add a new form to a project:

1. Click *PROJECT* on the Visual Studio menu bar, and then select *Add Windows Form...* from the *PROJECT* menu. The *Add New Item* window, shown in Figure 9-21, should appear.

**Figure 9-21** *Add New Item* window



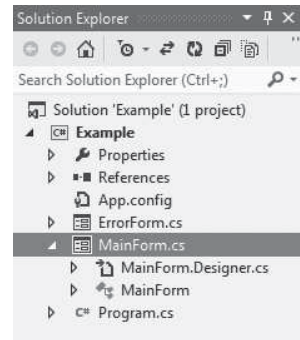
2. Near the bottom of the *Add New Item* window, a *Name* text box appears, where you can specify the new form's file name. Initially, a default name will appear here. (Notice that in Figure 9-21 the default name `Form1.cs` appears. The actual name that appears on your screen may be different.) Change the default name that is displayed in the *Name* text box to a more descriptive name. For example, if you

wish to name the new form `ErrorForm`, enter `ErrorForm.cs` in the *Name* text box. (Make sure you specify the `.cs` extension with the file name that you enter.)

3. Click the *Add* button.

After completing these steps, a new blank form is added to your project. The new form is displayed in the *Designer*, and an entry for the new form's file appears in the *Solution Explorer*. Figure 9-22 shows an example of the *Solution Explorer* with two form files: `ErrorForm.cs` and `MainForm.cs`. Once you have added a form to a project, you can place any controls on it that you desire and write the necessary event handlers for it.

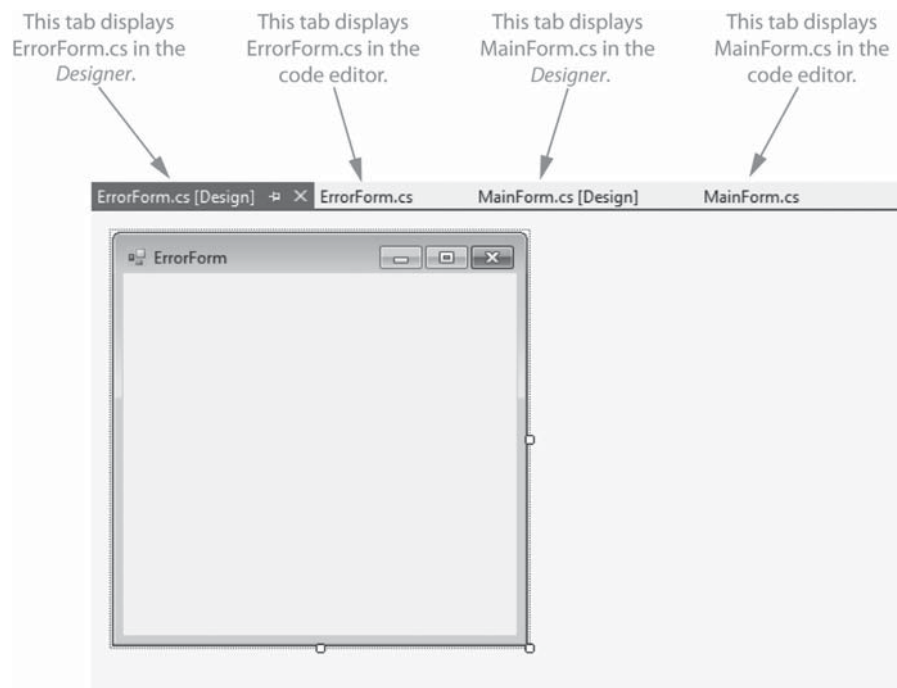
**Figure 9-22** *Solution Explorer* window showing two forms



## Switching between Forms and Form Code

In Visual Studio, you can easily switch your view to another form by double-clicking the form's entry in the *Solution Explorer* window. The form is then displayed in the *Designer*. You can also use the tabs that appear at the top of the *Designer* to display different forms or their code. For example, look at Figure 9-23. It shows the tabs that appear for a project with two forms: `ErrorForm` and `MainForm`. The tabs that display the *[Design]* designator cause a form to be displayed in the *Design* window. The tabs that appear without the designator cause a form's code to be displayed in the code editor.

**Figure 9-23** *Designer* tabs



When you open a form in the code editor, you will see several `using` directives, a namespace declaration, and the form's class. Figure 9-24 shows an example. The file in the figure contains the code for a form named `ErrorForm`. Notice that the form's class is named `ErrorForm`.

**Figure 9-24** A source code file containing a form class

```

ErrorForm.cs [Design]* | ErrorForm.cs* | MainForm.cs [Design] | MainForm.cs
Example.ErrorForm
using System;
using System.Collections.Generic;
using System.ComponentModel;
using System.Data;
using System.Drawing;
using System.Linq;
using System.Text;
using System.Threading.Tasks;
using System.Windows.Forms;

namespace Example
{
    public partial class ErrorForm : Form
    {
        public ErrorForm()
        {
            InitializeComponent();
        }
    }
}

```

## Removing a Form

If you wish to remove a form from a project and delete its file from the disk, follow these steps.

1. Right-click the form's entry in the *Solution Explorer* window.
2. On the pop-up menu, click *Delete*.

If you wish to remove a form from a project but you do not want to delete its file from the disk, follow these steps.

1. Right-click the form's entry in the *Solution Explorer* window.
2. On the pop-up menu click *Exclude From Project*.

## Displaying a Form

In your application's code, the first step in displaying a form is to create an instance of the form's class. For example, suppose a project has a form named `ErrorForm`. The following statement creates an instance of the `ErrorForm` class:

```
ErrorForm myErrorForm = new ErrorForm();
```

This statement declares a reference variable named `myErrorForm`. It also creates an object of the `ErrorForm` class in memory and assigns a reference to the object to the `myErrorForm` variable. After this statement executes, you will be able to use the `myErrorForm` variable to perform operations with the form.

Creating an instance of a form's class does not display the form on the screen. The next step is to call the form's `ShowDialog` method. Here is an example:

```
myErrorForm.ShowDialog();
```

The **ShowDialog** method displays a form on the screen, and it gives that form the focus. This means that control of the application transfers to the form. When the user closes the form, control of the application returns to the point where the `ShowDialog` method was called, and execution resumes.

Now that we've covered the basic concepts of creating and displaying a form, go through the steps in Tutorial 9-5. In the tutorial you create a simple application that has two forms.



VideoNote

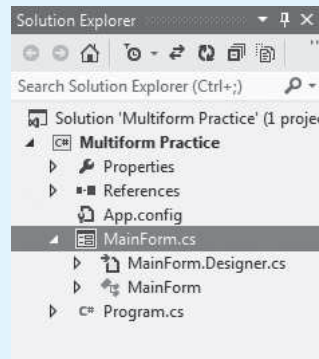
**Tutorial 9-5:**  
Creating an  
Application  
with Two  
Forms



## Tutorial 9-5: Creating an Application with Two Forms

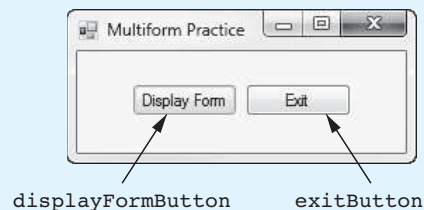
- Step 1:** Start Visual Studio (or Visual Studio Express). Create a new *Windows Forms Application* project named *Multiform Practice*.
- Step 2:** In the *Solution Explorer* window, rename the *Form1.cs* file to *MainForm.cs*. (Right-click *Form1.cs* and then select *Rename* from the pop-up menu.) Changing the form's file name to *MainForm.cs* changes the form's name to *MainForm*. The *Solution Explorer* window should appear as shown in Figure 9-25.

**Figure 9-25** *Solution Explorer* after changing *Form1.cs* to *MainForm.cs*



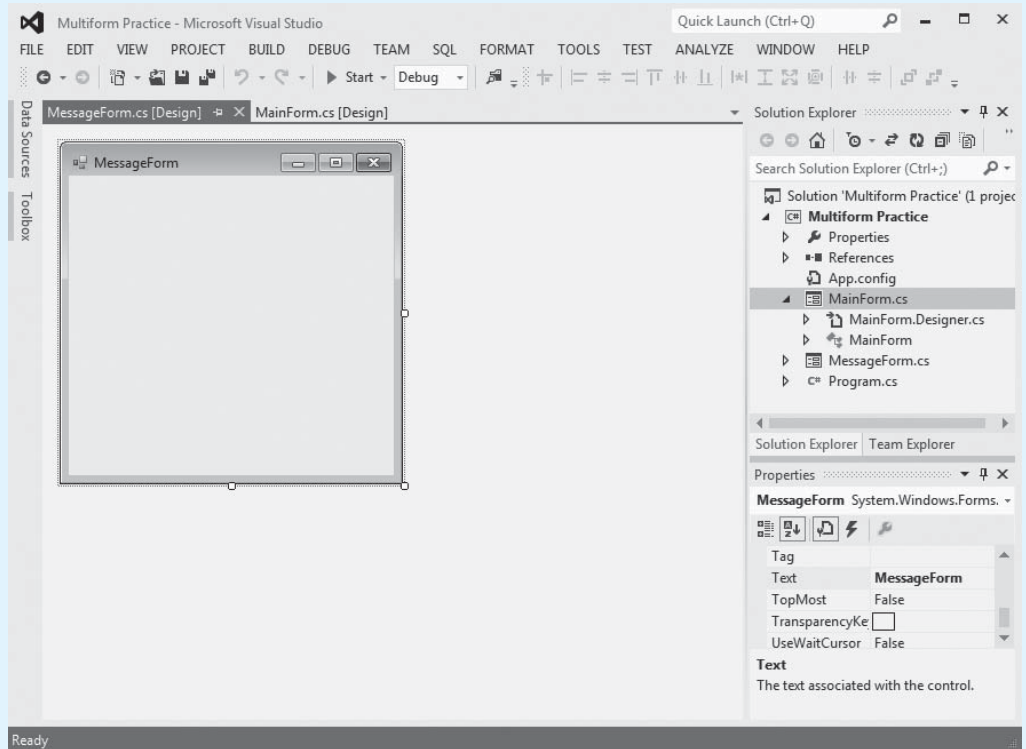
- Step 3:** In the *Designer*, set up the *MainForm* form as shown in Figure 9-26.

**Figure 9-26** *MainForm*

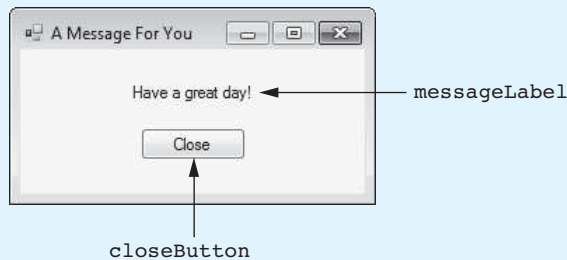


- Step 4:** Perform the following to create another form named *MessageForm* in the project:
- Click *PROJECT* on the menu bar and then select *Add Windows Form...*
  - The *Add New Item* window will appear. Enter *MessageForm.cs* as the name.
  - Click the *Add* button.

As shown in Figure 9-27, a new form named *MessageForm* will appear in the *Designer*. Notice that an entry for *MessageForm.cs* appears in the *Solution Explorer*.

**Figure 9-27** MessageForm added to the project

**Step 5:** In the *Designer*, set up the MessageForm as shown in Figure 9-28.

**Figure 9-28** MessageForm

**Step 6:** Next you create the Click event handler for the `closeButton` control. In the *Designer*, double-click the `closeButton` control. This displays the `MessageForm.cs` file in the code editor, and you will see an empty event handler named `closeButton_Click`. Complete the event handler by typing the code shown in lines 22–23 in Program 9-8. When the user clicks the `closeButton` control, this event handler closes the form.

**Step 7:** Use the tabs at the top of the *Designer* to switch to `MainForm.cs [Design]`. This brings up the `MainForm` in the *Designer*.

**Step 8:** Now you create the Click event handler for the `displayFormButton` control. Double-click the `displayFormButton` control. This displays the `MainForm.cs` file in the code editor, and you will see an empty event handler named `displayFormButton_Click`. Complete the event handler by typing the code shown in lines 22–26 in Program 9-9. Let's review this code:

**Line 23:** This statement does the following:

- It declares a `MessageForm` reference variable named `myMessageForm`.
- It creates a `MessageForm` object in memory.
- It assigns a reference to the `MessageForm` object to the `myMessageForm` variable.

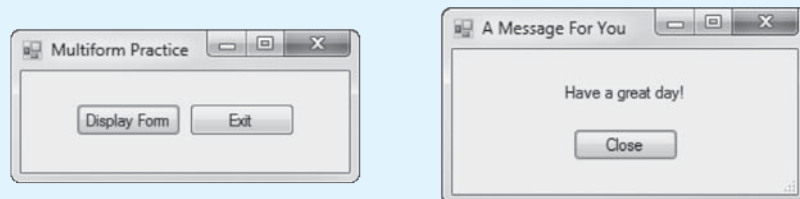
After this statement executes, the `myMessageForm` variable will reference a `MessageForm` object.

**Line 26:** This statement displays the `MessageForm` on the screen and transfers control of the application to the form.

**Step 9:** Switch your view back to the `MainForm` form in the *Designer* and double-click the `exitButton` control. In the code editor you will see an empty event handler named `exitButton_Click`. Complete the event handler by typing the code shown in lines 31–32 in Program 9-9.

**Step 10:** Save the project. Then, press `[F5]` on the keyboard or click the *Start Debugging* button (🐞) on the toolbar to compile and run the application. When the application runs, the `MainForm` should appear, as shown on the left in Figure 9-29. Click the *Display Form* button. The `MessageForm` form should appear, as shown on the right in Figure 9-29.

**Figure 9-29** The `MainForm` and the `MessageForm` forms displayed



**Step 11:** On the `MessageForm`, click the *Close* button. This should close the `MessageForm`. Next, click the *Exit* button on the `MainForm` to end the application.

#### Program 9-8 Completed code for the `MessageForm` form

```

1 using System;
2 using System.Collections.Generic;
3 using System.ComponentModel;
4 using System.Data;
5 using System.Drawing;
6 using System.Linq;
7 using System.Text;
8 using System.Threading.Tasks;
9 using System.Windows.Forms;
10
11 namespace Multiform_Practice

```



```

12 {
13     public partial class MessageForm : Form
14     {
15         public MessageForm()
16         {
17             InitializeComponent();
18         }
19
20         private void closeButton_Click(object sender, EventArgs e)
21         {
22             // Close the form.
23             this.Close();
24         }
25     }
26 }

```

---

**Program 9-9** Completed code for the MainForm form

```

1 using System;
2 using System.Collections.Generic;
3 using System.ComponentModel;
4 using System.Data;
5 using System.Drawing;
6 using System.Linq;
7 using System.Text;
8 using System.Threading.Tasks;
9 using System.Windows.Forms;
10
11 namespace Multiform_Practice
12 {
13     public partial class MainForm : Form
14     {
15         public MainForm()
16         {
17             InitializeComponent();
18         }
19
20         private void displayFormButton_Click(object sender, EventArgs e)
21         {
22             // Create an instance of the MessageForm class.
23             MessageForm myMessageForm = new MessageForm();
24
25             // Display the form.
26             myMessageForm.ShowDialog();
27         }
28
29         private void exitButton_Click(object sender, EventArgs e)
30         {
31             // Close the form.
32             this.Close();
33         }
34     }
35 }

```

---

## Modal and Modeless Forms

A form can be either modal or modeless. The `ShowDialog` method displays a form in modal fashion. When a **modal form** is displayed, no other form in the application can receive the focus until the modal form is closed. The user must close the modal form before he or she can work with any other form in the application. A **modeless form**, on the other hand, allows the user to switch focus to another form while it is displayed. The user does not have to close a modeless form to switch focus to another form. If you want to display a form in modeless fashion, call its **Show** method.

There is another important difference between modal and modeless forms. When you call the `ShowDialog` method to display a modal form, control of the program is transferred to the form, and no statements appearing after the `ShowDialog` method call will execute until the form is closed. Figure 9-30 illustrates this concept.

**Figure 9-30** Execution of statements after displaying a modal form

```
statement;
statement;
messageForm.ShowDialog();
statement;
statement;
statement;
```

These statements will not execute until the messageForm form is closed.

When you call the `Show` method to display a modeless form, however, the statements that appear after the `Show` method call continue to execute while the form is displayed. The application does not wait until the modeless form is closed before executing these statements. Figure 9-31 illustrates this concept.

**Figure 9-31** Execution of statements after displaying a modeless form

```
statement;
statement;
messageForm.ShowDialog();
statement;
statement;
statement;
```

These statements will execute immediately after the messageForm form is displayed.



**TIP:** Modeless forms are typically used in special situations. In most multiform applications, you will want to display forms in modal fashion.



### Checkpoint

- 9.25 What steps should you follow to change a form's name?
- 9.26 What steps should you follow to add a new form to a project?
- 9.27 How do you remove a form from a project and delete its file from the disk?
- 9.28 What is the first step in displaying a form?
- 9.29 What happens after a form that has been displayed with the `ShowDialog` method is closed by the user?

## Key Terms

accessors	overloaded
backing field	parameterized constructor
binding	parameterless constructor
class declaration	problem domain
class header	property
constructor	read-only property
default constructor	Show method
instance	ShowDialog method
member declarations	signature
modal form	stale
modeless form	value parameter

## Review Questions

### Multiple Choice

- Each object that is created from a class is called a(n) \_\_\_\_\_ of the class.
  - reference
  - example
  - instance
  - event
- You create a class by writing a(n) \_\_\_\_\_.
  - blueprint
  - class declaration
  - initialization list
  - object name
- The first line of a class declaration is known as the \_\_\_\_\_.
  - class preface
  - class title
  - class header
  - class directive
- The class's \_\_\_\_\_ are the statements that define the class's fields, properties, and methods.
  - data agents
  - body statements
  - private definitions
  - member declarations
- A(n) \_\_\_\_\_ is a method that is automatically executed when an object is created.
  - opener
  - loader
  - constructor
  - assembler
- A(n) \_\_\_\_\_ is a special type of class member that allows an object to store and retrieve a piece of data.
  - property
  - asset
  - inserter/retriever
  - accessory

7. A special set of methods, known as \_\_\_\_\_, work in conjunction with a private field and allow code outside the class to get the property's value, and assign values to the property.
  - a. accessors
  - b. imitators
  - c. intermediates
  - d. directives
8. The private field, which is known as the property's \_\_\_\_\_, holds any data that is assigned to the property.
  - a. private data
  - b. backing field
  - c. holding value
  - d. masked variable
9. The \_\_\_\_\_ parameter of the `set` accessor is automatically created by the compiler, and its data type is the same as that of the property.
  - a. `property`
  - b. `value`
  - c. `member`
  - d. `detail`
10. A \_\_\_\_\_ can be read, but it cannot be modified.
  - a. limited property
  - b. temporary value
  - c. field value
  - d. read-only property
11. When the value of an item is dependent on other data and that item is not updated when the other data is changed, what has the value become?
  - a. bitter
  - b. stale
  - c. asynchronous
  - d. moldy
12. A constructor that accepts arguments is known as a(n) \_\_\_\_\_.
  - a. argumentative constructor
  - b. changeable constructor
  - c. parameterized constructor
  - d. secondary constructor
13. When a method is \_\_\_\_\_, it means that multiple methods in the same class have the same name but use different types of parameters.
  - a. emulated
  - b. versioned
  - c. threaded
  - d. overloaded
14. The process of matching a method call with the correct method is known as \_\_\_\_\_.
  - a. sorting
  - b. matching
  - c. styling
  - d. binding

15. A method's \_\_\_\_\_ consists of the method's name and the data type and argument kind (by value, `ref`, or `out`) of the method's parameters, from left to right.
  - a. appearance
  - b. signature
  - c. identifier
  - d. footprint
16. A \_\_\_\_\_ is a constructor that accepts no arguments.
  - a. parameterless constructor
  - b. basic constructor
  - c. primary constructor
  - d. passive constructor
17. If you write a class with no constructor whatsoever, the compiler will provide a(n) \_\_\_\_\_.
  - a. default constructor
  - b. constructor list
  - c. parameterized method
  - d. error message
18. The \_\_\_\_\_ is the set of real-world objects, parties, and major events related to the problem.
  - a. critical path
  - b. problem domain
  - c. solution set
  - d. operation focus
19. A class's responsibilities are \_\_\_\_\_.
  - a. the objects created from the class
  - b. things the class knows
  - c. actions the class performs
  - d. both b and c
20. The \_\_\_\_\_ displays a form on the screen, and it gives that form the focus.
  - a. `Show` method
  - b. `ShowDialog` method
  - c. `Clear` method
  - d. `Focus` method

### True or False

1. Objects that are instances of a class are always passed by value.
2. Class declarations must be written inside the project namespace.
3. A class is an object.
4. It is a common practice to make all a class's fields private and to provide access to those fields through methods.
5. The same rules for naming variables apply to naming classes.
6. If you need to make a property read only, you simply do not write a `set` accessor for the property.
7. If you try to pass a property to a `ref` or an `out` parameter, an error will occur.
8. Class fields are almost always declared `public` in order to make their values easily accessible to code outside of the class.

9. The `get` accessor can be thought of as a method that returns the class property's value.
10. Constructors can accept arguments in the same way as other methods.
11. It is legal to write a class without any constructors.
12. Objects that are instances of a class can be stored in an array.
13. The objects of a class can be stored in an array, but not in a `List`.
14. One way to find the classes needed for an object-oriented program is to identify all the verbs in a description of the problem domain.
15. Every form in a Visual C# project has a class.

### Short Answer

1. When a method receives an object as an argument, does the method have access to the actual object or a copy of the object?
2. What are the advantages of storing classes in their own files?
3. How is a constructor used?
4. What is the difference between a class and an instance of a class?
5. What convention do most programmers follow when naming classes?
6. What is the `value` parameter? How is it created?
7. What is executed any time a class property is read?
8. What is executed any time a value is assigned to a class property?
9. How can you protect class fields from accidental corruption?
10. What is stale data?
11. Is it possible to pass initialization values to the constructor when you create an object? If so, how?
12. How does the compiler distinguish a method from other methods of the same name?
13. What do you call the constructor that is provided by the compiler, if no constructor is specified when a class is written?
14. In Visual Studio, how you can you switch your view to another form?
15. How do you remove a form from a project but keep its file on the disk?
16. What is the difference between a modal form and a modeless form?

### Algorithm Workbench

1. Write a statement that creates an instance of the `Transcript` class.
2. Write the accessors for a property named `CustomerNumber` that assigns a string value to the `_customerNumber` field.
3. Suppose that an application declares an array of class objects with the following statement:

```
Employee[] employees = new Employee[9];
```

Write a loop that creates 10 instances of the class and assigns them to the elements of the array.

## 4. Look at the following description of a problem domain:

The bank offers the following types of accounts to its customers: savings accounts, checking accounts, and money market accounts. Customers are allowed to deposit money into an account (thereby increasing its balance), withdraw money from an account (thereby decreasing its balance), and earn interest on the account. Each account has an interest rate.

Assume that you are writing a program that will calculate the amount of interest earned for a bank account.

- a. Identify the potential classes in this problem domain.
- b. Refine the list to include only the necessary class or classes for this problem.
- c. Identify the responsibilities of the class or classes.

## Programming Problems



VideoNote

Solving the  
Pet Class  
Problem

### 1. Pet Class

Create a class named `Pet` (similar to the one discussed in this chapter), which has the following properties:

- **Name**—The `Name` property holds the name of a pet.
- **Type**—The `Type` property holds the type of animal that a pet is. Example values are “Dog”, “Cat”, and “Bird”.
- **Age**—The `Age` property holds the pet’s age.

Demonstrate the class in an application that creates an object of the class and lets the user enter the name, type, and age of his or her pet. This data should be stored in the object. Retrieve the pet’s `Name`, `Type`, and `Age` properties and display their values on the screen.

### 2. Car Class

Create a class named `Car` that has the following properties:

- **Year**—The `Year` property holds the car’s year model.
- **Make**—The `Make` property holds the make of the car.
- **Speed**—The `Speed` property holds the car’s current speed.

In addition, the class should have the following constructor and other methods.

- **Constructor**—The constructor should accept the car’s year and model and make them as arguments. These values should be assigned to the backing fields for the object’s `Year` and `Make` properties. The constructor should also assign 0 to the backing field for the `Speed` property.
- **Accelerate**—The `Accelerate` method should add 5 to the `Speed` property’s backing field each time it is called.
- **Brake**—The `Brake` method should subtract 5 from the `Speed` property’s backing field each time it is called.

Demonstrate the class in an application that creates a `Car` object. The application’s form should have an *Accelerate* button that calls the `Accelerate` method and then displays the car’s current speed each time it is clicked. The application’s form should also have a *Brake* button that calls the `Brake` method and then displays the car’s current speed each time it is clicked.

### 3. Personal Information Class

Create a class that holds the following personal data in properties: name, address, age, and phone number. Demonstrate the class in an application that creates three instances of the class. One instance should hold your information, and the other two

should hold your friends' or family members' information. Display each object's properties on the application's form.

#### 4. **Employee Class**

Write a class named `Employee` that has the following properties:

- **Name**—The `Name` property holds the employee's name.
- **IdNumber**—The `IdNumber` property holds the employee's ID number.
- **Department**—The `Department` property holds the name of the department in which the employee works.
- **Position**—The `Position` property holds the employee's job title.

The class should have the following overloaded constructors:

- A constructor that accepts the following values as arguments and assigns them to the appropriate properties: employee's name, employee's ID number, department, and position
- A constructor that accepts the following values as arguments and assigns them to the appropriate properties: employee's name and ID number. The `Department` and `Position` properties should be assigned an empty string ("")
- A parameterless constructor that assigns empty strings ("") to the `Name`, `Department`, and `Position` properties, and 0 to the `IdNumber` property

In an application, create three `Employee` objects to hold the following data:

Name	ID Number	Department	Position
Susan Meyers	47899	Accounting	Vice President
Mark Jones	39119	IT	Programmer
Joy Rogers	81774	Manufacturing	Engineer

The application should store this data in the three objects and display the data for each employee on the screen.

#### 5. **RetailItem Class**

Write a class named `RetailItem` that holds data about an item in a retail store. The class should have the following properties:

- **Description**—The `Description` property should hold a brief description of the item.
- **UnitsOnHand**—The `UnitsOnHand` property should hold the number of units currently in inventory.
- **Price**—The `Price` property should hold the item's retail price.

Write a constructor that accepts arguments for each property.

The application should create an array of three `RetailItem` objects containing the following data:

	Description	Units on Hand	Price
Item 1	Jacket	12	59.95
Item 2	Jeans	40	34.95
Item 3	Shirt	20	24.95

The application should have a loop that steps through the array, displaying each element's properties.



## 6. Dorm and Meal Plan Calculator

A university has the following dormitories:

Allen Hall	\$1,500 per semester
Pike Hall	\$1,600 per semester
Farthing Hall	\$1,800 per semester
University Suites	\$2,500 per semester

The university also offers the following meal plans:

7 meals per week	\$ 600 per semester
14 meals per week	\$1,200 per semester
Unlimited meals	\$1,700 per semester

Create an application with two forms. The main form should allow the user to select a dormitory and a meal plan. The application should show the total charges on the second form.

## 7. E-Mail Address Book

Create an application with a class named `PersonEntry`. The `PersonEntry` class should have properties for a person's name, e-mail address, and phone number. Also, create a text file that contains the names, e-mail addresses, and phone numbers for at least five people. When the application starts, it should read the data from the file and create a `PersonEntry` object for each person's data. The `PersonEntry` objects should be added to a `List`, and each person's name should be displayed in a list box on the application's main form. When the user selects a name from the list box, a second form should appear displaying that person's name, e-mail address, and phone number.

## TOPICS

10.1 Inheritance

10.3 Abstract Classes

10.2 Polymorphism

## 10.1 Inheritance

**CONCEPT:** Inheritance allows a new class to extend an existing class. The new class inherits the members of the class it extends.

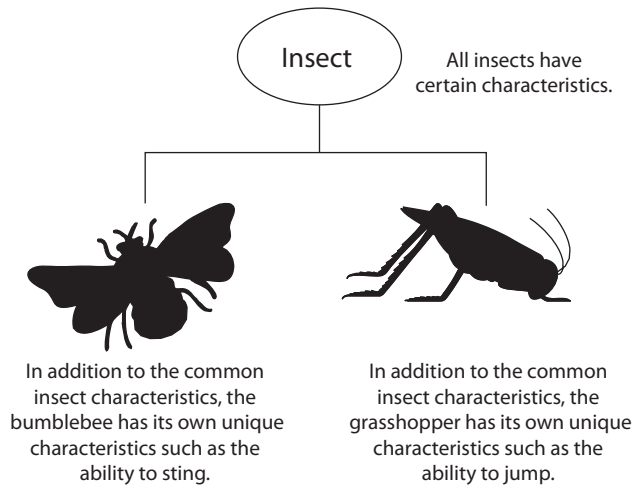
### Generalization and Specialization

In the real world you can find many objects that are specialized versions of other more general objects. For example, the term *insect* describes a very general type of creature with numerous characteristics. Because grasshoppers and bumblebees are insects, they have all the general characteristics of an insect. In addition, they have special characteristics of their own. For example, the grasshopper has its jumping ability, and the bumblebee has its stinger. Grasshoppers and bumblebees are specialized versions of an insect. This is illustrated in Figure 10-1.

### Inheritance and the “Is a” Relationship

When one object is a specialized version of another object, there is an “is a” relationship between them. For example, a grasshopper is an insect. Here are a few other examples of the “is a” relationship:

- A poodle is a dog.
- A car is a vehicle.
- A flower is a plant.
- A rectangle is a shape.
- A football player is an athlete.

**Figure 10-1** Bumblebees and grasshoppers, specialized versions of an insect

When an “is a” relationship exists between objects, it means that the specialized object has all of the characteristics of the general object, plus additional characteristics that make it special. In object-oriented programming, inheritance is used to create an “is a” relationship among classes. This allows you to extend the capabilities of a class by creating another class that is a specialized version of it.

Inheritance involves a base class and a derived class. The **base class** is the general class and the **derived class** is the specialized class. You can think of the derived class as an extended version of the base class. The derived class inherits fields, properties, and methods from the base class without any of them having to be rewritten. Furthermore, new fields, properties, and methods may be added to the derived class, and that is what makes it a specialized version of the base class.



**NOTE:** Base classes are sometimes called superclasses, and derived classes are sometimes called subclasses. Either set of terms is correct. For consistency, this text uses the terms *base class* and *derived class*.

Let’s look at an example of how inheritance can be used. Suppose we are developing an application that a car dealership can use to manage its inventory of used cars. The dealership’s inventory includes three types of automobiles: cars, pickup trucks, and sport-utility vehicles (SUVs). Regardless of the type, the dealership keeps the following data about each automobile:

- Make
- Year model
- Mileage
- Price

Each type of vehicle that is kept in inventory has these general characteristics plus its own specialized characteristics. For cars, the dealership keeps the following additional data:

- Number of doors (2 or 4)

For pickup trucks, the dealership keeps the following additional data:

- Drive type (two-wheel drive or four-wheel drive)

And, for SUVs, the dealership keeps the following additional data:

- Passenger capacity

In designing this program, one approach would be to write the following three classes:

- A `Car` class with properties for the make, year model, mileage, price, and the number of doors
- A `Truck` class with properties for the make, year model, mileage, price, and the drive type
- A `SportUtility` class with properties for the make, year model, mileage, price, and the passenger capacity

This is an inefficient approach, however, because all three classes have a large number of common properties. As a result, the classes would contain a lot of duplicated code. In addition, if we discover later that we need to add more common attributes, we would have to modify all three classes.

A better approach would be to write an `Automobile` base class to hold all the general data about an automobile and then write derived classes for each specific type of automobile. The following code shows the `Automobile` class:

```

1 class Automobile
2 {
3     // Fields
4     private string _make;
5     private string _model;
6     private int _mileage;
7     private decimal _price;
8
9     // Constructor
10    public Automobile()
11    {
12        _make = "";
13        _model = "";
14        _mileage = 0;
15        _price = 0;
16    }
17
18    // Make property
19    public string Make
20    {
21        get { return _make; }
22        set { _make = value; }
23    }
24
25    // Model property
26    public string Model
27    {
28        get { return _model; }
29        set { _model = value; }
30    }
31
32    // Mileage property
33    public int Mileage
34    {
35        get { return _mileage; }
36        set { _mileage = value; }
37    }
38
39    // Price property
40    public decimal Price

```

```

41     {
42         get { return _price; }
43         set { _price = value; }
44     }
45 }

```

Lines 4–7 declare the backing fields for the Make, Model, Mileage, and Price properties. The parameterless constructor, which appears in lines 10–16, assigns empty strings to the `_make` and `_model` fields and 0 to the `_mileage` and `_price` fields. The code for the Make, Model, Mileage, and Price properties appears in lines 19–44.

The `Automobile` class is a complete class from which we can create objects. However, the `Automobile` class holds only general data about an automobile. It does not hold any of the specific pieces of data that the dealership wants to keep about cars, pickup trucks, and SUVs. To hold data about those specific types of automobiles, we write derived classes that inherit from the `Automobile` class. The following code shows the `Car` class, which is derived from the `Automobile` class.

```

1 class Car : Automobile
2 {
3     // Field
4     private int _doors;
5
6     // Constructor
7     public Car()
8     {
9         _doors = 0;
10    }
11
12    // Doors property
13    public int Doors
14    {
15        get { return _doors; }
16        set { _doors = value; }
17    }
18 }

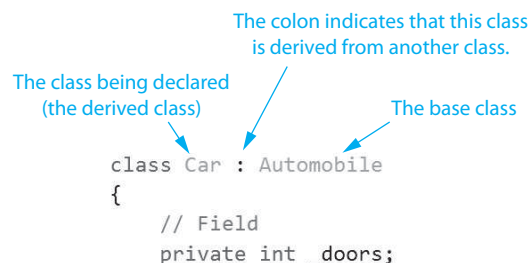
```

Take a closer look at the class header in line 1:

```
class Car : Automobile
```

This line of code has some new notation. After the name of the class, `Car`, a colon appears, followed by the name of another class, `Automobile`. This line indicates that we are defining a class named `Car`, and it is derived from the `Automobile` class. The `Car` class is the derived class and the `Automobile` class is the base class. Figure 10-2 illustrates this notation. If we want to express the relationship between the `Car` class and the `Automobile` class, we can say that a `Car` is an `Automobile`.

**Figure 10-2** Inheritance notation in the class header



Because the `Car` class is derived from the `Automobile` class, the `Car` class inherits all the `Automobile` class's members, except its constructor. (The purpose of the base class's constructor is to create an instance of the base class, so it makes sense that the derived class does not inherit the base class's constructor.)



**NOTE:** Although the derived class inherits the base class's private members, it cannot directly access them. Only methods in the base class can directly access the base class's private members.

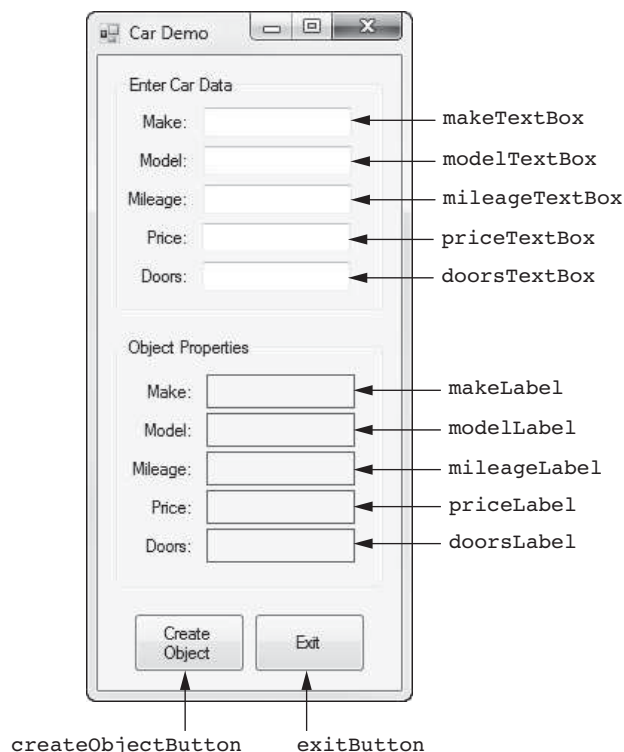
The `Car` class has a parameterless constructor that appears in lines 7–10. In line 9, the constructor assigns the value 0 to the `_doors` field. Here is a summary of what happens when an object of the `Car` class is created:

- The base class constructor executes first. In this case, the `Automobile` class's constructor is called, and it assigns empty strings to the `_make` and `_model` fields and 0 to the `_mileage` and `_price` fields.
- The derived class constructor executes next. In this case, 0 is assigned to the `_doors` field.

The code for the `Doors` property appears in lines 13–17.

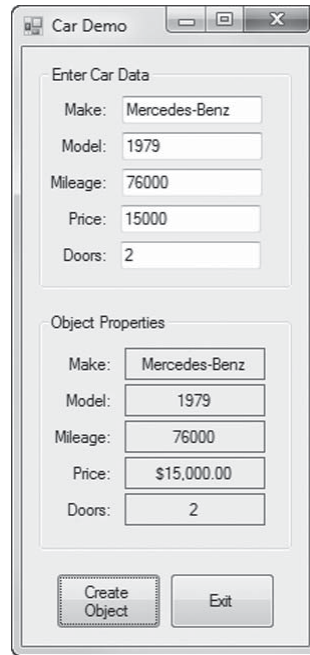
Before going any further, let's look at a complete application that demonstrates the `Automobile` and `Car` classes. In the *Chap10* folder of the Student Sample Programs you will find a project named *Car Demo*. This project contains a form named `Form1`, the `Automobile` class, and the `Car` class. Figure 10-3 shows the `Form1` form.

**Figure 10-3** The *Car Demo* project's `Form1` form



When you run the application, enter sample car data into the text boxes and then click the *Create Object* button. The application will create an object of the *car* class and assign the data from the text boxes to the object's properties. It will then read and display the values of the object's properties in the *makeLabel*, *modelLabel*, *mileageLabel*, *priceLabel*, and *doorsLabel* controls. Figure 10-4 shows an example of the application's form after the user has entered some data and clicked the *Create Object* button.

**Figure 10-4** The *Car Demo* application



Program 10-1 shows the code in the *Form1.cs* file.

**Program 10-1** *Form1* code in the *Car Demo* project

```

1 using System;
2 using System.Collections.Generic;
3 using System.ComponentModel;
4 using System.Data;
5 using System.Drawing;
6 using System.Linq;
7 using System.Text;
8 using System.Threading.Tasks;
9 using System.Windows.Forms;
10
11 namespace Car_Demo
12 {
13     public partial class Form1 : Form
14     {
15         public Form1()
16         {
17             InitializeComponent();
18         }
19
20         // The GetCarData method accepts a Car object as an
21         // argument. It assigns the data entered by the

```

```

22 // user to the object's properties.
23 private void GetCarData(Car car)
24 {
25     // Temporary variables to hold mileage, price,
26     // and number of doors
27     int mileage;
28     decimal price;
29     int doors;
30
31     // Get the car's make.
32     car.Make = makeTextBox.Text;
33
34     // Get the car's model.
35     car.Model = modelTextBox.Text;
36
37     // Get the car's mileage.
38     if (int.TryParse(mileageTextBox.Text, out mileage))
39     {
40         car.Mileage = mileage;
41
42         // Get the car's price.
43         if (decimal.TryParse(priceTextBox.Text, out price))
44         {
45             car.Price = price;
46
47             // Get the number of doors.
48             if (int.TryParse(doorsTextBox.Text, out doors))
49             {
50                 car.Doors = doors;
51             }
52             else
53             {
54                 // Display an error message.
55                 MessageBox.Show("Invalid number of doors");
56             }
57         }
58         else
59         {
60             // Display an error message.
61             MessageBox.Show("Invalid price");
62         }
63     }
64     else
65     {
66         // Display an error message.
67         MessageBox.Show("Invalid mileage");
68     }
69 }
70
71 private void createObjectButton_Click(object sender, EventArgs e)
72 {
73     // Create a Car object.
74     Car myCar = new Car();
75
76     // Get the car data.
77     GetCarData(myCar);
78
79     // Display the car data.
80     makeLabel.Text = myCar.Make;
81     modelLabel.Text = myCar.Model;
82     mileageLabel.Text = myCar.Mileage.ToString();

```



```

83         priceLabel.Text = myCar.Price.ToString("c");
84         doorsLabel.Text = myCar.Doors.ToString();
85     }
86
87     private void exitButton_Click(object sender, EventArgs e)
88     {
89         // Close the form.
90         this.Close();
91     }
92 }
93 }

```

---

Let's take a closer look at the code:

**Lines 23–69:** This is the code for the `GetCarData` method. The purpose of the method is to accept a `Car` object as an argument, get the car data entered by the user (performing input validation on the mileage, price, and doors), and store that data in the `Car` object's properties.

**Line 74:** This statement creates an instance of the `Car` class, referenced by the `myCar` variable.

**Line 77:** This statement calls the `GetCarData` method, passing the `myCar` object as an argument. After the method executes, the `myCar` object's properties will contain the data entered by the user.

**Lines 80–84:** These statements display the `myCar` object's properties.

Now let's take a look at the `Truck` and `SportUtility` classes, which are also derived from the `Automobile` class. Here is the code for the `Truck` class:

```

1 class Truck : Automobile
2 {
3     // Field
4     private string _drive;
5
6     // Constructor
7     public Truck()
8     {
9         _drive = "";
10    }
11
12    // Drive property
13    public string Drive
14    {
15        get { return _drive; }
16        set { _drive = value; }
17    }
18 }

```

The `Truck` class has a `string` property named `Drive`. This property holds a value such as "Four-Wheel Drive" or "Two-Wheel Drive." The backing field for the property is named `_drive` and is declared in line 4. The code for the property is in lines 13–17. The constructor, which appears in lines 7–10, assigns an empty string to the `_drive` field.

Now, let's look at the `SportUtility` class, which is also derived from the `Automobile` class:

```

1 class SportUtility : Automobile
2 {
3     // Field
4     private int _passengers;
5

```

```

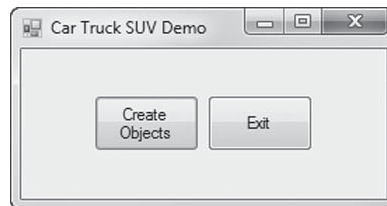
6     // Constructor
7     public SportUtility()
8     {
9         _passengers = 0;
10    }
11
12    // Passengers property
13    public int Passengers
14    {
15        get { return _passengers; }
16        set { _passengers = value; }
17    }
18 }

```

The `SportUtility` class has an `int` property named `Passengers`. This property holds the vehicle's passenger capacity. The backing field for the property is named `_passengers` and is declared in line 4. The code for the property is in lines 13–17. The constructor, which appears in lines 7–10, assigns an empty string to the `_passengers` field.

Now, let's look at a program that demonstrates all four of these classes. In the *Chap10* folder of the Student Sample Programs, you will find a project named *Car Truck SUV Demo*. This project contains a form named `Form1`, the `Automobile` class, the `Car` class, the `Truck` class, and the `SportUtility` class. Figure 10-5 shows the `Form1` form, and Program 10-2 shows the code in the `Form1.cs` file.

**Figure 10-5** The *Car Truck SUV Demo* project's `Form1` form



**Program 10-2** `Form1` code in the *Car Truck SUV Demo* project

```

1 using System;
2 using System.Collections.Generic;
3 using System.ComponentModel;
4 using System.Data;
5 using System.Drawing;
6 using System.Linq;
7 using System.Text;
8 using System.Threading.Tasks;
9 using System.Windows.Forms;
10
11 namespace Car_Truck_SUV_Demo
12 {
13     public partial class Form1 : Form
14     {
15         public Form1()
16         {
17             InitializeComponent();
18         }
19
20         private void createObjectsButton_Click(object sender, EventArgs e)
21         {
22             // Create a Car object for a used 2001 BMW with 70,000
23             // miles, priced at $15,000, with 4 doors.

```

```

24         Car myCar = new Car();
25         myCar.Make = "BMW";
26         myCar.Model = "2001";
27         myCar.Mileage = 70000;
28         myCar.Price = 15000;
29         myCar.Doors = 4;
30
31         // Create a Truck object for a used 2002 Toyota
32         // pickup with 40,000 miles, priced at $12,000,
33         // with four wheel drive.
34         Truck myTruck = new Truck();
35         myTruck.Make = "Toyota";
36         myTruck.Model = "2002";
37         myTruck.Mileage = 40000;
38         myTruck.Price = 12000;
39         myTruck.Drive = "Four Wheel Drive";
40
41         // Create a SportUtility object for a used 2000
42         // Volvo with 30,000 miles, priced at $15,500,
43         // with a passenger capacity of 5.
44         SportUtility mySUV = new SportUtility();
45         mySUV.Make = "Volvo";
46         mySUV.Model = "2000";
47         mySUV.Mileage = 30000;
48         mySUV.Price = 15500;
49         mySUV.Passengers = 5;
50
51         // Display data about the car.
52         MessageBox.Show(myCar.Model + " " + myCar.Make + " with " +
53             myCar.Mileage + " miles, priced at " +
54             myCar.Price.ToString("c") + ", with " + myCar.Doors +
55             " doors.");
56
57         // Display data about the truck.
58         MessageBox.Show(myTruck.Model + " " + myTruck.Make +
59             " with " + myTruck.Mileage + " miles, priced at " +
60             myTruck.Price.ToString("c") + ", with " +
61             myTruck.Drive);
62
63         // Display data about the SUV.
64         MessageBox.Show(mySUV.Model + " " + mySUV.Make + " with " +
65             mySUV.Mileage + " miles, priced at " +
66             mySUV.Price.ToString("c") + ", with " + mySUV.Passengers +
67             " passengers.");
68     }
69
70     private void exitButton_Click(object sender, EventArgs e)
71     {
72         // Close the form.
73         this.Close();
74     }
75 }
76 }

```

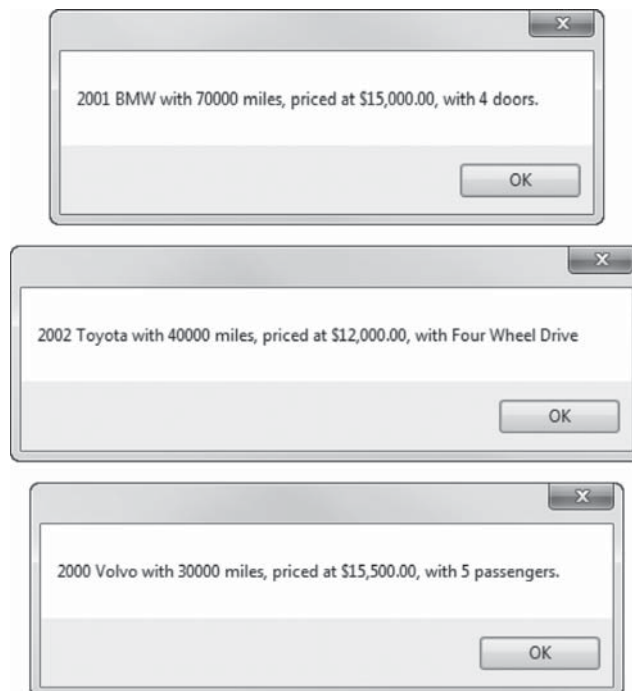
Let's step through the code in the `createObjectsButton_Click` event handler. Line 24 creates an instance of the `Car` class, referenced by the `myCar` variable. Lines 25–29 assign values to the objects `Make`, `Model`, `Mileage`, `Price`, and `Doors` properties.

Line 34 creates an instance of the `Truck` class, referenced by the `myTruck` variable. Lines 35–39 assign values to the objects `Make`, `Model`, `Mileage`, `Price`, and `Drive` properties.

Line 44 creates an instance of the `SportUtility` class, referenced by the `mySUV` variable. Lines 45–49 assign values to the objects `Make`, `Model`, `Mileage`, `Price`, and `Passengers` properties.

Lines 52–55 display the properties of the `myCar` object in the topmost message box shown in Figure 10-6. Lines 58–61 display the properties of the `myTruck` object in the middle message box shown in Figure 10-6. Lines 64–67 display the properties of the `mySUV` object in the bottom message box shown in Figure 10-6.

**Figure 10-6** Message boxes displayed by the *Car Truck SUV Demo* project



In Tutorial 10-1 you create a base class for a savings account, and a derived class for a certificate of deposit.



VideoNote

**Tutorial 10-1:**  
Creating and  
Testing the  
Savings  
Account and  
CDAccount  
Classes

### Tutorial 10-1:

#### Creating and Testing the `SavingsAccount` and `CDAccount` Classes

Bank Financial Systems, Inc., develops financial software for banks and credit unions. The company is developing a new system that manages customer accounts. One of your tasks is to develop a class that represents a savings account. The data that must be held by an object of this class is

- The account number
- The interest rate
- The account balance

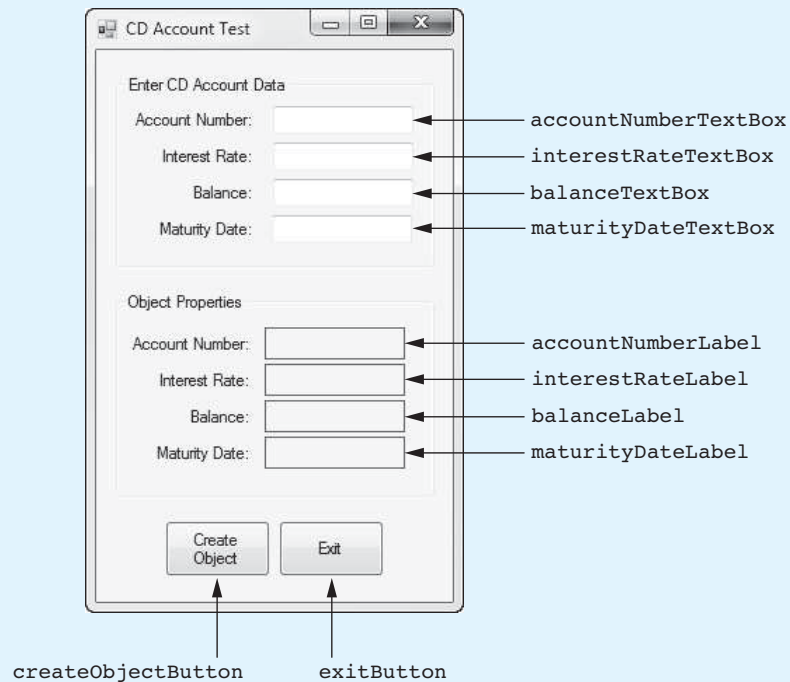
You must also develop a class that represents a certificate of deposit (CD) account. The data that must be held by an object of this class is

- The account number
- The interest rate
- The account balance
- The account maturity date

As you analyze these requirements, you realize that a CD account is really a specialized version of a savings account. The class that represents a CD will hold all the same data as the class that represents a savings account, plus an extra property for the maturity date. You decide to create a `SavingsAccount` class to represent a savings account and then create a class that is derived from `SavingsAccount`, named `CDAccount`, to represent a CD account.

To test the classes, you will use them in an application that lets the user enter data about a CD account, creates an object of the `CDAccount` class, sets the object's properties to the data that the user entered, and then displays the object's data. The application's form, which has already been created for you, is shown in Figure 10-7.

**Figure 10-7** The *CD Account Test* application's form



**Step 1:** Start Visual Studio (or Visual Studio Express). Open the project named *CD Account Test* in the *Chap10* folder of the Student Sample Programs.

**Step 2:** Click *PROJECT* on the Visual Studio menu bar and then select *Add Class....* The *Add New Item* window should appear. Make sure *Class* is selected as the type of item. Change the default filename to *SavingsAccount.cs* and then click the *Add* button. This adds a source code file named *SavingsAccount.cs* to the project.

**Step 3:** The *SavingsAccount.cs* file should now be displayed in the code editor. Complete the code for the `savingsAccount` class by typing lines 11–43 in Program 10-3. The class code is very straightforward. It declares properties named

AccountNumber, InterestRate, and Balance, as well as the backing fields for the properties. The class also has a parameterless constructor that initializes the backing fields to default values.

**Step 4:** Click *PROJECT* on the Visual Studio menu bar and then select *Add Class...* The *Add New Item* window should appear. Make sure *Class* is selected as the type of item. Change the default filename to *CDAccount.cs* and then click the *Add* button. This adds a source code file named *CDAccount.cs* to the project.

**Step 5:** The *CDAccount.cs* file should now be displayed in the code editor. Complete the code for the *CDAccount* class as follows:

- At the end of the class header type `: SavingsAccount` to indicate that this class is derived from the *SavingsAccount* class. (See line 9 in Program 10-4.)
- Type the code shown in lines 11–25 in Program 10-4. The class code is very straightforward. It declares a property named *MaturityDate* as well as the backing field for the property. The class also has a parameterless constructor that initializes the backing field to an empty string.

**Step 6:** Open the *Form1.cs* file in the code editor. Type the comments and code for the *GetCDDData* method, shown in lines 20–57 of Program 10-5. Notice in line 23 that the method has a *CDAccount* parameter named *account*. When we call this method, we pass a *CDAccount* object to it as an argument.

The purpose of the *GetCDDData* method is to read the data that the user has entered into the form's text boxes and store that data in the *account* object's properties. The values that have been entered for the interest rate and the balance are validated.


**Step 7:** Next you create the Click event handlers for the Button controls. Switch your view to the *Form1* form in the *Designer*. Double-click the *createObjectButton* control. This opens the *Form1.cs* file in the code editor, and you will see an empty event handler named *createObjectButton\_Click*. Complete the event handler by typing the code shown in lines 61–71 in Program 10-5. Let's review this code:

**Line 62:** This statement creates a *CDAccount* object in memory, referenced by a variable named *myAccount*.

**Line 65:** This statement calls the *GetCDDData* method, passing the *myAccount* object as an argument. After the method executes, the *myAccount* object's properties will be set to the values entered by the user.

**Lines 68–71:** These statements display the values of the *myAccount* object's properties.

**Step 8:** Switch your view back to the *Form1* form in the *Designer* and double-click the *exitButton* control. In the code editor you will see an empty event handler named *exitButton\_Click*. Complete the event handler by typing the code shown in lines 76–77 in Program 10-5.

**Step 9:** Save the project. Then, press **F5** on the keyboard or click the *Start Debugging* button (  ) on the toolbar to compile and run the application. When the application runs, enter some sample data in the *TextBox* controls and click the *Create Object* button. You should see the values that you entered displayed in the *Object Properties* group box. Figure 10-8 shows an example. Click the *Exit* button when you are finished.

**Figure 10-8** The *CD Account Test* application



**NOTE:** The `MaturityDate` property in the `CDAccount` class is implemented as a `string`. If you prefer, you can use the `DateTime` data type provided by the .NET Framework. We have not covered the `DateTime` data type in this book, but if you feel adventurous, you can explore it on your own and devise a way to implement the `MaturityDate` property as a `DateTime` instead of a `string`.

**Program 10-3** Completed code for the `SavingsAccount.cs` file in the *CD Account Test* application

```

1 using System;
2 using System.Collections.Generic;
3 using System.Linq;
4 using System.Text;
5 using System.Threading.Tasks;
6
7 namespace CD_Account_Test
8 {
9     class SavingsAccount
10    {
11        // Fields
12        private string _accountNumber;
13        private decimal _interestRate;
14        private decimal _balance;
15
16        // Constructor
17        public SavingsAccount()
18        {
19            _accountNumber = "";
20            _interestRate = 0;
21            _balance = 0;
22        }
23
24        // AccountNumber property

```

```

25     public string AccountNumber
26     {
27         get { return _accountNumber; }
28         set { _accountNumber = value; }
29     }
30
31     // InterestRate property
32     public decimal InterestRate
33     {
34         get { return _interestRate; }
35         set { _interestRate = value; }
36     }
37
38     // Balance property
39     public decimal Balance
40     {
41         get { return _balance; }
42         set { _balance = value; }
43     }
44 }
45 }

```

---

**Program 10-4** Completed code for the `CDAccount.cs` file in the *CD Account Test* application

```

1 using System;
2 using System.Collections.Generic;
3 using System.Linq;
4 using System.Text;
5 using System.Threading.Tasks;
6
7 namespace CD_Account_Test
8 {
9     class CDAccount : SavingsAccount
10    {
11        // Field
12        private string _maturityDate;
13
14        // Constructor
15        public CDAccount()
16        {
17            _maturityDate = "";
18        }
19
20        // MaturityDate property
21        public string MaturityDate
22        {
23            get { return _maturityDate; }
24            set { _maturityDate = value; }
25        }
26    }
27 }

```

---

**Program 10-5** Completed code for `Form1` in the *CD Account Test* application

```

1 using System;
2 using System.Collections.Generic;
3 using System.ComponentModel;

```



```

4 using System.Data;
5 using System.Drawing;
6 using System.Linq;
7 using System.Text;
8 using System.Threading.Tasks;
9 using System.Windows.Forms;
10
11 namespace CD_Account_Test
12 {
13     public partial class Form1 : Form
14     {
15         public Form1()
16         {
17             InitializeComponent();
18         }
19
20         // The GetCDData method accepts a CDAccount object
21         // as an argument. It assigns the data entered by
22         // the user to the object's properties.
23         private void GetCDData(CDAccount account)
24         {
25             // Temporary variables to hold interest rate
26             // and balance
27             decimal interestRate;
28             decimal balance;
29
30             // Get the account number.
31             account.AccountNumber = accountNumberTextBox.Text;
32
33             // Get the maturity date.
34             account.MaturityDate = maturityDateTextBox.Text;
35
36             // Get the interest rate.
37             if (decimal.TryParse(interestRateTextBox.Text, out interestRate))
38             {
39                 account.InterestRate = interestRate;
40
41                 // Get the balance.
42                 if (decimal.TryParse(balanceTextBox.Text, out balance))
43                 {
44                     account.Balance = balance;
45                 }
46                 else
47                 {
48                     // Display an error message.
49                     MessageBox.Show("Invalid balance");
50                 }
51             }
52             else
53             {
54                 // Display an error message.
55                 MessageBox.Show("Invalid interest rate");
56             }
57         }
58
59         private void createObjectButton_Click(object sender, EventArgs e)
60         {
61             // Create a CDAccount object.
62             CDAccount myAccount = new CDAccount();
63

```

```

64         // Get the CD account data.
65         GetCDData(myAccount);
66
67         // Display the CD account data.
68         accountNumberLabel.Text = myAccount.AccountNumber;
69         interestRateLabel.Text = myAccount.InterestRate.ToString("n2");
70         balanceLabel.Text = myAccount.Balance.ToString("c");
71         maturityDateLabel.Text = myAccount.MaturityDate;
72     }
73
74     private void exitButton_Click(object sender, EventArgs e)
75     {
76         // Close the form.
77         this.Close();
78     }
79 }
80 }

```

## Base Class and Derived Class Constructors

When you create an instance of a derived class, the base class constructor is executed first, and then the derived class constructor is executed. In all the examples that we have discussed so far, the base class and the derived class have parameterless constructors. When you create an instance of a derived class, by default the base class's parameterless constructor is automatically executed.

But what happens if the base class's constructor has parameters? Or, what happens if the base class has multiple, overloaded constructors and you want to make sure a specific one is called? In either of these situations, the derived class constructor must explicitly call the base class constructor.

For example, look at the following `Rectangle` class:

```

1 class Rectangle
2 {
3     // Fields
4     private int _length;
5     private int _width;
6
7     // Constructor
8     public Rectangle()
9     {
10         _length = 0;
11         _width = 0;
12     }
13
14     // Constructor
15     public Rectangle(int length, int width)
16     {
17         _length = length;
18         _width = width;
19     }
20
21     // Length property
22     public int Length
23     {
24         get { return _length; }
25         set { _length = value; }
26     }

```

```

27
28     // Width property
29     public int Width
30     {
31         get { return _width; }
32         set { _width = value; }
33     }
34 }

```

This class holds data about a rectangle. It has Length and Width properties to store a rectangle's length and width. It also has two constructors: a parameterless constructor (lines 8–12) that initializes `_length` and `_width` to 0 and a constructor that accepts arguments for the length and the width (lines 15–19).

The following `Box` class is derived from the `Rectangle` class:

```

1 class Box : Rectangle
2 {
3     // Field
4     private int _height;
5
6     // Constructor
7     public Box()
8     {
9         _height = 0;
10    }
11
12    // Constructor
13    public Box(int length, int width, int height)
14        : base(length, width)
15    {
16        _height = height;
17    }
18
19    // Height property
20    public int Height
21    {
22        get { return _height; }
23        set { _height = value; }
24    }
25 }

```

The `Box` class holds data about a rectangular box, which has a length, width, and height. The class inherits the Length and Width properties from the `Rectangle` class, and it has its own Height property. Notice that the `Box` class has two constructors: a parameterless constructor (lines 7–10) and a parameterized constructor (lines 13–17).

If you create an instance of the `Box` class, calling its parameterless constructor, the `Rectangle` class's parameterless constructor will be executed. Here is an example:

```
Box myBox = new Box();
```

After this statement executes, the `myBox` object's Length, Width, and Height properties will be set to 0.

Now, let's look at the `Box` class's parameterized constructor. The following code appears in line 13:

```
public Box(int length, int width, int height)
```

This constructor has three parameters: `length`, `width`, and `height`. Notice the following code in line 14:

```
: base(length, width)
```

The **base** keyword refers to the base class. This is an explicit call to the base class's parameterized constructor, passing `length` and `width` as arguments. To understand how this works, consider the following statement:

```
Box myBox = new Box(100, 200, 300);
```

This statement creates an instance of the `Box` class, passing 100 into the `length` parameter, 200 into the `width` parameter, and 300 into the `height` parameter. The code in line 14 of the `Box` class calls the `Rectangle` class's parameterized constructor, passing `length` and `width` as arguments. After the `Rectangle` class's constructor executes, the `Box` class constructor resumes execution. The resulting `Box` object's `Length` property will be set to 100, its `Width` property will be set to 200, and its `Height` property will be set to 300.

## Summary of Constructor Issues in Inheritance

- When you create an instance of a derived class, the base class constructor is executed first and then the derived class constructor is executed.
- When you create an instance of a derived class, by default the base class's parameterless constructor is automatically executed.
- If you want a parameterized constructor in the base class to execute, you must explicitly call it from the derived class's constructor. You do this by writing the notation `: base(parameterList)` in the derived class's constructor header.
- If the base class does not have a parameterless constructor, the derived class constructor must use the notation `: base(parameterList)` to call one of the base class's parameterized constructors.



### Checkpoint

- 10.1 In this section we discussed base classes and derived classes. Which is the general class and which is the specialized class?
- 10.2 What does it mean to say there is an “is a” relationship between two objects?
- 10.3 What does a derived class inherit from its base class?
- 10.4 Look at the following code, which is the first line of a class declaration. What is the name of the base class? What is the name of the derived class?  

```
class Canary : Bird
```
- 10.5 Briefly summarize the constructor issues in inheritance.

## 10.2

## Polymorphism

**CONCEPT:** Polymorphism allows derived classes to have methods with the same names as methods in their base classes. It gives the ability for a program to call the correct method, depending on the type of object that is used to call it.

The term **polymorphism** refers to an object's ability to take different forms. It is a powerful feature of object-oriented programming. In this section, we look at two essential ingredients of polymorphic behavior:

1. The ability to define a method in a base class and then define a method with the same name in a derived class. When a derived class method has the same name as a

base class method, it is often said that the derived class method **overrides** the base class method.

2. The ability to call the correct version of an overridden method, depending on the type of object that is used to call it. If a derived class object is used to call an overridden method, then the derived class's version of the method is the one that executes. If a base class object is used to call an overridden method, then the base class's version of the method is the one that executes.

Perhaps the best way to describe polymorphism is to demonstrate it, so let's consider a simple example. Look at the following code for the `Animal` class:

```

1 class Animal
2 {
3     // Field
4     private string _species;
5
6     // Constructor
7     public Animal(string species)
8     {
9         _species = species;
10    }
11
12    // Species property
13    public string Species
14    {
15        get { return _species; }
16        set { _species = value; }
17    }
18
19    // MakeSound method
20    public virtual void MakeSound()
21    {
22        MessageBox.Show("Grrrrrrr");
23    }
24 }
```

Line 4 declares the `string` field `_species`. This is the backing field for the `Species` property, defined in lines 13–17. The constructor in lines 7–10 takes an argument that is assigned to the `_species` field.

The class has a method named `MakeSound`, in lines 20–23. The method simply displays "Grrrrrrr" in a message box. Notice the `virtual` keyword that appears in the method header. The **virtual** keyword declares that a derived class is allowed to override this method.

Here is an example of code that uses an instance of the `Animal` class:

```

1 Animal myAnimal = new Animal("regular animal");
2 MessageBox.Show("The species is " + myAnimal.Species);
3 myAnimal.MakeSound();
```

The statement in line 1 creates an object of the `Animal` class, passing the string "regular animal" to the constructor. The object is referenced by the `myAnimal` variable. Line 2 displays "The species is regular animal" in a message box. Line 3 calls the `myAnimal` object's `MakeSound` method, which displays "Grrrrrrr" in a message box.

Next, look at the `Dog` class, which is derived from the `Animal` class:

```

1 class Dog : Animal
2 {
3     // Field
4     private string _name;
5
```

```

6     // Constructor
7     public Dog(string name) : base ("Dog")
8     {
9         _name = name;
10    }
11
12    // Name property
13    public string Name
14    {
15        get { return _name; }
16        set { _name = value; }
17    }
18
19    // MakeSound method
20    public override void MakeSound()
21    {
22        MessageBox.Show("Woof! Woof!");
23    }
24 }

```

Line 4 declares the `string` field `_name`. This is the backing field for the `Name` property, defined in lines 13–17. The constructor in lines 7–10 takes an argument for the dog’s name. Notice that the constructor calls the base class constructor, passing the string `"Dog"` as an argument. The `Animal` class constructor assigns the string `"Dog"` to the `_species` field.

Although the `Dog` class is derived from the `Animal` class, the `Animal` class’s `MakeSound` method is inadequate for the `Dog` class. So, the `Dog` class overrides the `Animal` class’s `MakeSound` method. The `Dog` class’s `MakeSound` method, in lines 20–23, displays `"Woof! Woof!"` in a message box, which is more appropriate for a dog. Notice the `override` keyword that appears in the method header. The `override` keyword declares that this method overrides a method in the base class.

Here is an example of code that uses an instance of the `Dog` class:

```

1 Dog myDog = new Dog("Fido");
2 MessageBox.Show("The species is " + myDog.Species);
3 MessageBox.Show("The animal's name is " + myDog.Name);
4 myDog.MakeSound();

```

The statement in line 1 creates an object of the `Dog` class, passing the string `"Fido"` to the constructor. The object is referenced by the `myDog` variable. Line 2 displays “The species is Dog” in a message box. Line 3 displays “The animal’s name is Fido” in a message box. Line 4 calls the `myDog` object’s `MakeSound` method. When we use a `Dog` object to call the `MakeSound` method, the version of the method that is in the `Dog` class is the one that executes. So, the statement in line 4 displays “Woof! Woof!” in a message box.

Next, look at the `Cat` class, which is also derived from the `Animal` class:

```

1 class Cat : Animal
2 {
3     // Field
4     private string _name;
5
6     // Constructor
7     public Cat(string name) : base("Cat")
8     {
9         _name = name;
10    }
11
12    // Name property
13    public string Name

```

```

14     {
15         get { return _name; }
16         set { _name = value; }
17     }
18
19     // MakeSound method
20     public override void MakeSound()
21     {
22         MessageBox.Show("Meow");
23     }
24 }

```

Line 4 declares the `string` field `_name`. This is the backing field for the `Name` property, defined in lines 13–17. The constructor in lines 7–10 takes an argument for the cat’s name. Notice that the constructor calls the base class constructor, passing the string `"Cat"` as an argument. The `Animal` class constructor assigns the string `"Cat"` to the `_species` field.

Although the `Cat` class is derived from the `Animal` class, the `Animal` class’s `MakeSound` method is inadequate for the `Cat` class. So, the `Cat` class overrides the `Animal` class’s `MakeSound` method. The `Cat` class’s `MakeSound` method, in lines 20–23, displays `"Meow"` in a message box, which is more appropriate for a cat. Notice the `override` keyword that appears in the method header

Here is an example of code that uses an instance of the `Cat` class:

```

1 Cat myCat = new Cat("Kitty");
2 MessageBox.Show("The species is " + myCat.Species);
3 MessageBox.Show("The animal's name is " + myCat.Name);
4 myCat.MakeSound();

```

The statement in line 1 creates an object of the `Cat` class, passing the string `"Kitty"` to the constructor. The object is referenced by the `myCat` variable. Line 2 displays “The species is Cat” in a message box. Line 3 displays “The animal’s name is Kitty” in a message box. Line 4 calls the `myCat` object’s `MakeSound` method. When we use a `Cat` object to call the `MakeSound` method, the version of the method that is in the `Cat` class is the one that executes. So, the statement in line 4 displays “Meow” in a message box.

Because of the “is a” relationship between a base class and a derived class, an object of the `Dog` class is not just a `Dog` object. It is also an `Animal` object. (A dog is an animal.) Because of this relationship, we can use an `Animal` class variable to reference a `Dog` object. For example, look at the following code:

```

1 Animal myAnimal = new Dog("Fido");
2 MessageBox.Show("The species is " + myAnimal.Species);
3 myAnimal.MakeSound();

```

Line 1 declares `myAnimal` as a variable of the `Animal` type. It also creates an object of the `Dog` class and assigns a reference to the `Dog` object to the `myAnimal` variable. After this statement executes, we will have an `Animal` variable referencing a `Dog` object. This assignment is legal because a `Dog` object is also an `Animal` object. Line 2 displays “The species is Dog” in a message box. Line 3 calls the `myAnimal` object’s `MakeSound` method, which displays “Woof! Woof!” in a message box.

Similarly, we can use an `Animal` variable to reference a `Cat` object, as shown in the following code:

```

1 Animal myAnimal = new Cat("Kitty");
2 MessageBox.Show("The species is " + myAnimal.Species);
3 myAnimal.MakeSound();

```

The statement in line 2 displays “The species is Cat” in a message box. Line 3 calls the `myAnimal` object’s `MakeSound` method, which displays “Meow” in a message box.

## Overriding Properties

Properties in a base class can be overridden in the same way that methods can be overridden. In the base class, you write the `virtual` keyword in the property declaration, as shown here:

```
public virtual double Weight
{
    get { return _weight; }
    set { _weight = value; }
}
```

This example declares a virtual property named `Weight`. To override the property in the derived class you write the `override` keyword in the property declaration. For example, suppose that in a derived class we want to override the `Weight` property so the `get` accessor returns the weight on the moon. Here is an example:

```
public override double Weight
{
    get { return _weight * 0.165; }
    set { _weight = value; }
}
```

## Base Class Reference Variables Know about Base Class Members Only

A base class reference variable can reference an object of any class that is derived from the base class. However, there is a limit to what the base class variable can do with those objects. A base class reference variable knows only about the members that are declared in the base class. If the derived class introduces additional methods, properties, or fields, a base class reference variable cannot access them. For example, look at the following code:

```
1 Animal myAnimal = new Dog("Fido");
2 MessageBox.Show("The species is " + myAnimal.Species);
3 MessageBox.Show("The animal's name is " + myAnimal.Name); // ERROR!
4 myAnimal.MakeSound();
```

Line 3 in this code will not compile. The `myAnimal` variable is an `Animal` reference variable, and the `Animal` class does not have a `Name` property. Even though the `myAnimal` variable is referencing a `Dog` object, it cannot access the object's `Name` property.

## The “Is a” Relationship Does Not Work in Reverse

It is important to understand that the “is a” relationship does not work in reverse. Although the statement “a dog is an animal” is true, the statement “an animal is a dog” is not true. This is because all dogs are animals, but not all animals are dogs. So, the following statement will not compile:

```
Dog myDog = new Animal("Dog");
```

You cannot assign an `Animal` reference to a `Dog` variable. This makes sense because `Dog` objects have capabilities that go beyond those of an `Animal` object.



**NOTE:** Interestingly, the C# compiler will allow you to make such an assignment if you use a cast operator, as shown here:

```
Dog myDog = (Dog) new Animal("Dog");
```

However, an exception will be thrown at run time when the assignment takes place.



## Passing Objects to Base Class Parameters

Polymorphism gives you a great deal of flexibility when designing applications. For example, look at the following method:

```
private void ShowAnimalInfo(Animal animal)
{
    MessageBox.Show("Species: " + animal.Species);
    animal.MakeSound();
}
```

This method displays information about an animal. Because it has an `Animal` variable as its parameter, you can pass an `Animal` object to the method when you call it. The method then displays the object's `Species` property and calls its `MakeSound` method.

The `ShowAnimalInfo` method works with an `Animal` object, but what if you also need methods that display the same information about `Dog` objects and `Cat` objects? Do you need to write additional methods for each of these types? Because of polymorphism, the answer is *no*. In addition to `Animal` objects, you can also pass `Dog` objects or `Cat` objects as arguments to the `ShowAnimalInfo` method previously shown.

In Tutorial 10-2 you complete an application that uses the `Animal`, `Dog`, and `Cat` classes to demonstrate polymorphism.



### Tutorial 10-2: Completing the *Polymorphism* Application



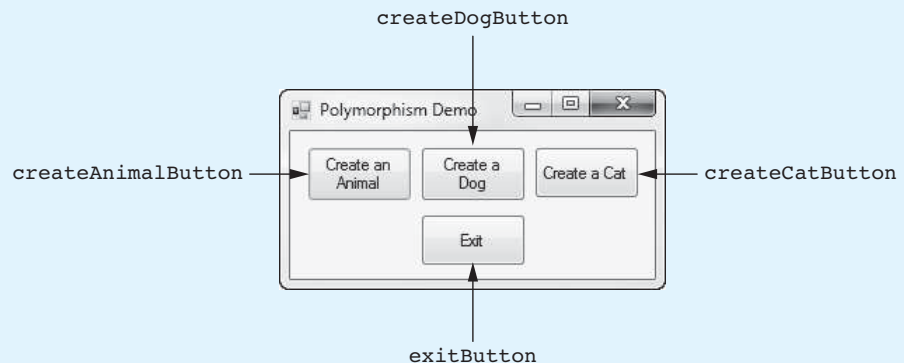
VideoNote

**Tutorial 10-2:**  
Completing  
the *Poly-*  
*morphism*  
Application

In this tutorial you complete the *Polymorphism* application, which demonstrates the `Animal`, `Dog`, and `Cat` classes shown in this section. The application also incorporates the `ShowAnimalInfo` method previously described.

The application's form, which has already been created for you, is shown in Figure 10-9. When you run the completed application, clicking the *Create an Animal* button creates an object of the `Animal` class and passes the object to the `ShowAnimalInfo` method. Clicking the *Create a Dog* button creates an object of the `Dog` class and passes that object to the `ShowAnimalInfo` method. Clicking the *Create a Cat* button creates an object of the `Cat` class and passes that object to the `ShowAnimalInfo` method.

**Figure 10-9** The *Polymorphism* application's form



**Step 1:** Start Visual Studio (or Visual Studio Express). Open the project named *Polymorphism* in the *Chap10* folder of the Student Sample Programs.

**Step 2:** Click *PROJECT* on the Visual Studio menu bar and then select *Add Class...* The *Add New Item* window should appear. Make sure *Class* is selected as the

type of item. Change the default filename to *Animal.cs* and then click the *Add* button. This adds a source code file named *Animal.cs* to the project.

**Step 3:** The *Animal.cs* file should now be displayed in the code editor. Add the `using` directive shown in line 6 of Program 10-6. This is necessary in order for the class to call the `MessageBox.Show` method. Next, complete the code for the *Animal* class by typing lines 12–32 in Program 10-6.

**Step 4:** Click *PROJECT* on the Visual Studio menu bar and then select *Add Class...* The *Add New Item* window should appear. Make sure *Class* is selected as the type of item. Change the default filename to *Dog.cs* and then click the *Add* button. This adds a source code file named *Dog.cs* to the project.

**Step 5:** The *Dog.cs* file should now be displayed in the code editor. Add the `using` directive shown in line 6 of Program 10-7. This is necessary in order for the class to call the `MessageBox.Show` method. Next, add the `: Animal` notation to the class header, shown in line 10 of Program 10-7. Then, complete the code for the *Dog* class by typing lines 12–33 in Program 10-7.

**Step 6:** Click *PROJECT* on the Visual Studio menu bar and then select *Add Class...* The *Add New Item* window should appear. Make sure *Class* is selected as the type of item. Change the default filename to *Cat.cs*, and then click the *Add* button. This adds a source code file named *Cat.cs* to the project.

**Step 7:** The *Cat.cs* file should now be displayed in the code editor. Add the `using` directive shown in line 6 of Program 10-8. This is necessary in order for the class to call the `MessageBox.Show` method. Next, add the `: Animal` notation to the class header, shown in line 10 of Program 10-8. Then, complete the code for the *Dog* class by typing lines 12–33 in Program 10-8.

**Step 8:** Open the *Form1.cs* file in the code editor. Type the comments and code for the `ShowAnimalInfo` method shown in lines 20–27 of Program 10-9.

**Step 9:** Next you create the Click event handlers for the Button controls. Switch your view to the *Form1* form in the Designer. Double-click the `createAnimalButton` control. This opens the *Form1.cs* file in the code editor, and you will see an empty event handler named `createAnimalButton_Click`. Complete the event handler by typing the code shown in lines 31–32 in Program 10-9.

Let's review this code. Line 31 creates an object of the *Animal* class, passing "Regular animal" as an argument to the constructor. Line 32 passes the object to the `ShowAnimalInfo` method.


**Step 10:** Switch your view to the *Form1* form in the *Designer*. Double-click the `createDogButton` control. This will open the *Form1.cs* file in the code editor, and you will see an empty event handler named `createDogButton_Click`. Complete the event handler by typing the code shown in lines 37–39 in Program 10-9.

Let's review this code. Line 37 creates an object of the *Dog* class, passing "Fido" as an argument to the constructor. Line 38 displays the object's `Name` property in a message box. Line 39 passes the object to the `ShowAnimalInfo` method.

**Step 11:** Switch your view to the *Form1* form in the Designer. Double-click the `createCatButton` control. This opens the *Form1.cs* file in the code editor, and you will see an empty event handler named `createCatButton_Click`. Complete the event handler by typing the code shown in lines 44–46 in Program 10-9.

Let's review this code. Line 44 creates an object of the *Cat* class, passing "Kitty" as an argument to the constructor. Line 45 displays the object's `Name` property in a message box. Line 46 passes the object to the `ShowAnimalInfo` method.

**Step 12:** Switch your view back to the Form1 form in the *Designer* and double-click the `exitButton` control. In the code editor you will see an empty event handler named `exitButton_Click`. Complete the event handler by typing the code shown in lines 51–52 in Program 10-9.

**Step 13:** Save the project. Then, press `[F5]` on the keyboard or click the *Start Debugging* button  on the toolbar to compile and run the application. When the application runs, click the *Create an Animal* button. You should see the following messages displayed in message boxes:

Species: Regular animal

Grrrrrrr

Next, click the *Create a Dog* button. You should see the following messages displayed in message boxes:

The dog's name is Fido

Species: Dog

Woof! Woof!

Next, click the *Create a Cat* button. You should see the following messages displayed in message boxes:

The cat's name is Kitty

Species: Cat

Meow

Click the *Exit* button when you are finished.

---

**Program 10-6** Completed code for the `Animal.cs` file in the *Polymorphism* application

```

1 using System;
2 using System.Collections.Generic;
3 using System.Linq;
4 using System.Text;
5 using System.Threading.Tasks;
6 using System.Windows.Forms; // Needed for MessageBox
7
8 namespace Polymorphism
9 {
10     class Animal
11     {
12         // Field
13         private string _species;
14
15         // Constructor
16         public Animal(string species)
17         {
18             _species = species;
19         }
20
21         // Species property
22         public string Species
23         {
24             get { return _species; }
25             set { _species = value; }
26         }
27
28         // MakeSound method
29         public virtual void MakeSound()

```

```

30     {
31         MessageBox.Show("Grrrrrrr");
32     }
33 }
34 }

```

---

**Program 10-7** Completed code for the Dog.cs file in the *Polymorphism* application

```

1 using System;
2 using System.Collections.Generic;
3 using System.Linq;
4 using System.Text;
5 using System.Threading.Tasks;
6 using System.Windows.Forms; // Needed for MessageBox
7
8 namespace Polymorphism
9 {
10     class Dog : Animal
11     {
12         // Field
13         private string _name;
14
15         // Constructor
16         public Dog(string name)
17             : base("Dog")
18         {
19             _name = name;
20         }
21
22         // Name property
23         public string Name
24         {
25             get { return _name; }
26             set { _name = value; }
27         }
28
29         // MakeSound method
30         public override void MakeSound()
31         {
32             MessageBox.Show("Woof! Woof!");
33         }
34     }
35 }

```

---

**Program 10-8** Completed code for the Cat.cs file in the *Polymorphism* application

```

1 using System;
2 using System.Collections.Generic;
3 using System.Linq;
4 using System.Text;
5 using System.Threading.Tasks;
6 using System.Windows.Forms; // Needed for MessageBox
7
8 namespace Polymorphism
9 {
10     class Cat : Animal
11     {
12         // Field
13         private string _name;

```

```

14
15     // Constructor
16     public Cat(string name)
17         : base("Cat")
18     {
19         _name = name;
20     }
21
22     // Name property
23     public string Name
24     {
25         get { return _name; }
26         set { _name = value; }
27     }
28
29     // MakeSound method
30     public override void MakeSound()
31     {
32         MessageBox.Show("Meow");
33     }
34 }
35 }

```

---

**Program 10-9** Completed code for Form1 in the *Polymorphism* application

```

1 using System;
2 using System.Collections.Generic;
3 using System.ComponentModel;
4 using System.Data;
5 using System.Drawing;
6 using System.Linq;
7 using System.Text;
8 using System.Threading.Tasks;
9 using System.Windows.Forms;
10
11 namespace Polymorphism
12 {
13     public partial class Form1 : Form
14     {
15         public Form1()
16         {
17             InitializeComponent();
18         }
19
20         // The ShowAnimalInfo method accepts an Animal
21         // object as an argument. It displays the object's
22         // species and calls its MakeSound method.
23         private void ShowAnimalInfo(Animal animal)
24         {
25             MessageBox.Show("Species: " + animal.Species);
26             animal.MakeSound();
27         }
28
29         private void createAnimalButton_Click(object sender, EventArgs e)
30         {
31             Animal myAnimal = new Animal("Regular animal");
32             ShowAnimalInfo(myAnimal);
33         }
34
35         private void createDogButton_Click(object sender, EventArgs e)

```

```

36     {
37         Dog myDog = new Dog("Fido");
38         MessageBox.Show("The dog's name is " + myDog.Name);
39         ShowAnimalInfo(myDog);
40     }
41
42     private void createCatButton_Click(object sender, EventArgs e)
43     {
44         Cat myCat = new Cat("Kitty");
45         MessageBox.Show("The cat's name is " + myCat.Name);
46         ShowAnimalInfo(myCat);
47     }
48
49     private void exitButton_Click(object sender, EventArgs e)
50     {
51         // Close the form.
52         this.Close();
53     }
54 }
55 }

```

## Checkpoint

10.6 Look at the following class definitions:

```

class Vegetable
{
    public virtual void message()
    {
        MessageBox.Show("I'm a vegetable.");
    }
}
class Potato : Vegetable
{
    public override void message()
    {
        MessageBox.Show("I'm a potato.");
    }
}

```

Given these class declarations, what will the following code display?

```

Vegetable v = new Potato();
Potato p = new Potato();
v.message();
p.message();

```

10.7 Does the “is a” relationship work in reverse? Why or why not?

## 10.3 Abstract Classes

**CONCEPT:** An abstract class serves as a base class but is not instantiated itself. An abstract method has no body and must be overridden in a derived class.

Sometimes it does not make sense to instantiate a base class. For example, consider a factory that manufactures airplanes. The factory does not make a generic airplane but makes

two specific types of airplanes: a prop-driven plane and a commuter jet. The computer software that catalogs the planes might use a class named `Airplane`. The `Airplane` class has members representing the common characteristics of all airplanes. In addition, the software has a class named `PropPlane` and a class named `CommuterJet`. These classes represent the two specific airplane models the factory manufactures and are derived from the `Airplane` class. The `Airplane` class is never instantiated but is used as a base class for the other classes.

A class that is not intended to be instantiated but is to be used only as a base class is called an **abstract class**. An abstract class serves as a starting point, providing some members for its derived classes. To declare a class as abstract, you use the `abstract` keyword in the class header. Here is the general format:

```
abstract class ClassName
{
    // Member declarations
}
```

The primary difference between an abstract class and a regular class (which is sometimes called a **concrete class**) is that the abstract class cannot be instantiated. A statement that tries to use the `new` operator to instantiate an abstract class will not compile.

Abstract classes can also contain abstract methods. An **abstract method** is a method that appears in a base class but expects to be overridden in a derived class. An abstract method has only a header and no body. In the header, the `abstract` keyword appears before the return type. Here is a very simple example of an abstract class that contains an abstract method:

```
abstract class Person
{
    public abstract void DoSomething();
}
```

When an abstract method appears in a class, it must be overridden in any class that is derived from the class. In this example, if a class is derived from the `Person` class, the derived class must override the `DoSomething` method.

Abstract classes can also contain abstract properties. An **abstract property** is a property that appears in a base class but expects to be overridden in a derived class. In the property header, the `abstract` keyword appears before the property type. Here is a very simple example of an abstract class that contains an abstract method:

```
abstract class Person
{
    public abstract string JobTitle
    {
        get;
        set;
    }
}
```

Notice that the abstract property shows `get` and `set` accessors, but it does not specify what those accessors do. When an abstract property appears in a class, it must be overridden in any class that is derived from the class. In this example, if a class is derived from the `Person` class, the derived class must override the `JobTitle` property.



**NOTE:** If you want to create an abstract read-only property, leave out the `set` accessor.

In Tutorial 10-3 you complete an application that uses an abstract base class with an abstract property.



### Tutorial 10-3: Completing the *Computer Science Student* Application



VideoNote

**Tutorial 10-3:**  
Completing  
the *Computer  
Science  
Student  
Application*

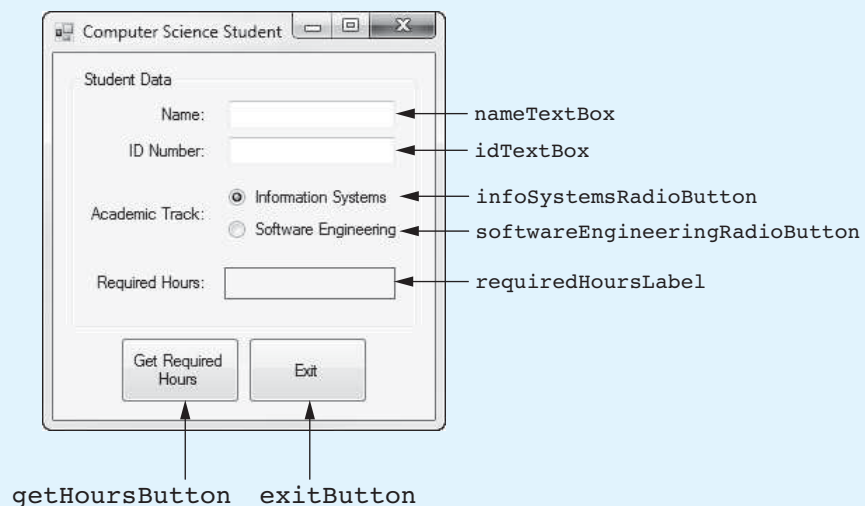
In this tutorial you write an abstract class named `Student`. The `Student` class holds data that is common to all students, but it does not hold all the data needed for students of specific majors. The `Student` class is intended to be a base class that can be derived by other classes that represent students of specific majors.

The `Student` class has a `Name` property to hold a student's name and an `ID` property to hold a student's ID number. It also has an abstract read-only property named `RequiredHours`. The purpose of the `RequiredHours` property is to hold the number of required hours for a specific major. Any class that is derived from the `Student` class must override the `RequiredHours` property.

You also write a class named `CompSciStudent`, which is derived from the `Student` class. The `CompSciStudent` class has a field named `AcademicTrack`, which holds the name of the student's academic track. It also overrides the `RequiredHours` property to calculate and return the number of hours required for a computer science major.

You will demonstrate the classes in the *Computer Science Student* application. The application's form, which has already been created for you, is shown in Figure 10-10. When you run the completed application, you will enter a student's name and ID number into the text boxes, and you will select an academic track using the radio buttons. When you click the *Get Required Hours* button, the application will create a `CompSciStudent` object, initialized with the data you entered. It will then get the value of the `RequiredHours` property and display it on the form.

**Figure 10-10** The *Computer Science Student* application's form



**Step 1:** Start Visual Studio (or Visual Studio Express). Open the project named *Computer Science Student* in the *Chap10* folder of the Student Sample Programs.

**Step 2:** Click *PROJECT* on the Visual Studio menu bar and then select *Add Class...*. The *Add New Item* window should appear. Make sure *Class* is selected as the type of item. Change the default filename to *Student.cs* and then click the *Add* button. This adds a source code file named *Student.cs* to the project.



**Step 3:** The `Student.cs` file should now be displayed in the code editor. Add the `abstract` keyword to the class header, shown in line 9 of Program 10-10. Next, complete the code for the `Student` class by typing lines 11–40 in Program 10-10.

**Step 4:** Click *PROJECT* on the Visual Studio menu bar and then select *Add Class...*. The *Add New Item* window should appear. Make sure *Class* is selected as the type of item. Change the default filename to *CompSciStudent.cs* and then click the *Add* button. This adds a source code file named `CompSciStudent.cs` to the project.

**Step 5:** The `CompSciStudent.cs` file should now be displayed in the code editor. Add the `: Student` notation to the class header, shown in line 9 of Program 10-11. Then, complete the code for the `CompSciStudent` class by typing lines 11–37 in Program 10-11.

Notice that the `RequiredHours` property, in lines 34–37, overrides the abstract `RequiredHours` property in the base class. This property calculates and returns the number of required hours.

**Step 6:** Now you will create the Click event handlers for the Button controls. Switch your view to the `Form1` form in the *Designer*. Double-click the `getHoursButton` control. This opens the `Form1.cs` file in the code editor, and you will see an empty event handler named `getHoursButton_Click`. Complete the event handler by typing the code shown in lines 22–45 in Program 10-12. Let's review this code:

**Line 23:** This statement declares three local `string` variables: `name`, `id`, and `track`. They will be used to hold user input.

**Lines 26–27:** These statements get the name and ID number entered by the user and assign those values to the `name` and `id` variables.

**Lines 30–37:** This `if-else` statement determines which radio button is selected and assigns a value to the `track` variable.

**Lines 40–41:** This statement creates a `CompSciStudent` object, referenced by the variable `csStudent`, and initializes it with the data entered by the user.

**Lines 44–45:** This statement gets the value of the `csStudent` object's `RequiredHours` property and displays it in the `requiredHoursLabel1` control.

**Step 7:** Switch your view back to the `Form1` form in the *Designer* and double-click the `exitButton` control. In the code editor you will see an empty event handler named `exitButton_Click`. Complete the event handler by typing the code shown in lines 50–51 in Program 10-12.

**Step 8:** Save the project. Then, press `(F5)` on the keyboard or click the *Start Debugging* button (🐞) on the toolbar to compile and run the application. When the application runs, enter some sample data in the `TextBox` controls, select a value with the radio buttons, and click the *Get Required Hours* button. You should see the value 120.0 displayed as the number of required hours. Click the *Exit* button when you are finished.

---

**Program 10-10** Completed code for the `Student.cs` file in the *Computer Science Student* application

```

1 using System;
2 using System.Collections.Generic;
3 using System.Linq;
4 using System.Text;
5 using System.Threading.Tasks;

```

```

6
7 namespace Computer_Science_Student
8 {
9     abstract class Student
10    {
11        // Fields
12        private string _name;
13        private string _id;
14
15        // Constructor
16        public Student(string name, string id)
17        {
18            _name = name;
19            _id = id;
20        }
21
22        // Name property
23        public string Name
24        {
25            get { return _name; }
26            set { _name = value; }
27        }
28
29        // ID property
30        public string ID
31        {
32            get { return _id; }
33            set { _id = value; }
34        }
35
36        // RequiredHours property (abstract)
37        public abstract double RequiredHours
38        {
39            get;
40        }
41    }
42 }

```

---

**Program 10-11** Completed code for the `CompSciStudent.cs` file in the *Computer Science Student* application

```

1 using System;
2 using System.Collections.Generic;
3 using System.Linq;
4 using System.Text;
5 using System.Threading.Tasks;
6
7 namespace Computer_Science_Student
8 {
9     class CompSciStudent : Student
10    {
11        // Constants
12        private double MATH_HOURS = 20;
13        private double CS_HOURS = 40;
14        private double GEN_HOURS = 60;
15
16        // Fields
17        private string _academicTrack;
18

```

```

19         // Constructor
20         public CompSciStudent(string name, string id, string track)
21             : base(name, id)
22         {
23             _academicTrack = track;
24         }
25
26         // AcademicTrack property
27         public string AcademicTrack
28         {
29             get { return _academicTrack; }
30             set { _academicTrack = value; }
31         }
32
33         // RequiredHours property
34         public override double RequiredHours
35         {
36             get { return MATH_HOURS + CS_HOURS + GEN_HOURS; }
37         }
38     }
39 }

```

---

**Program 10-12** Completed code for Form1 in the *Computer Science Student* application

```

1 using System;
2 using System.Collections.Generic;
3 using System.ComponentModel;
4 using System.Data;
5 using System.Drawing;
6 using System.Linq;
7 using System.Text;
8 using System.Threading.Tasks;
9 using System.Windows.Forms;
10
11 namespace Computer_Science_Student
12 {
13     public partial class Form1 : Form
14     {
15         public Form1()
16         {
17             InitializeComponent();
18         }
19
20         private void getHoursButton_Click(object sender, EventArgs e)
21         {
22             // Variables to hold input
23             string name, id, track;
24
25             // Get the student's name and ID.
26             name = nameTextBox.Text;
27             id = idTextBox.Text;
28
29             // Get the student's academic track.
30             if (infoSystemsRadioButton.Checked)
31             {
32                 track = "Information Systems";
33             }
34             else
35             {

```

```
36         track = "Software Engineering";
37     }
38
39     // Create a CompSciStudent object.
40     CompSciStudent csStudent =
41         new CompSciStudent(name, id, track);
42
43     // Display the student's required hours.
44     requiredHoursLabel.Text =
45         csStudent.RequiredHours.ToString("n1");
46     }
47
48     private void exitButton_Click(object sender, EventArgs e)
49     {
50         // Close the form.
51         this.Close();
52     }
53 }
54 }
```



### Checkpoint

- 10.8 What is the purpose of an abstract class?
- 10.9 If a class is abstract, what cannot be done with the class?
- 10.10 If a class is derived from a base class that has an abstract method, what must the derived class do?
- 10.11 What must be done with an abstract property before it can be used?
- 10.12 How can you create an abstract read-only property?

## Key Terms

abstract class	“is a” relationship
abstract keyword	override keyword
abstract method	overrides
abstract property	polymorphism
base class	subclasses
base keyword	superclasses
concrete class	virtual keyword
derived class	

## Review Questions

### Multiple Choice

- When one object is a specialized version of another object, there is an \_\_\_\_\_ between them.
  - “is a” relationship
  - innate association
  - inherent union
  - unbreakable union
- In an inheritance relationship, the \_\_\_\_\_ is the general class.
  - derived class
  - base class
  - dependent class
  - child class
- In an inheritance relationship, the \_\_\_\_\_ is the specialized class.
  - base class
  - master class
  - derived class
  - parent class
- Base classes are sometimes called \_\_\_\_\_.
  - megaclasses
  - primitive classes
  - starter classes
  - superclasses
- Derived classes are sometimes called \_\_\_\_\_.
  - refined classes
  - subclasses
  - child classes
  - neoclasses
- The \_\_\_\_\_ refers to the base class.
  - friend keyword
  - this keyword
  - base keyword
  - class keyword
- The term \_\_\_\_\_ refers to an object’s ability to take different forms.
  - multi-instance
  - by referencing
  - polymorphism
  - oligopoly

8. When a derived class method has the same name as a base class method, it is often said that the derived class method \_\_\_\_\_ the base class method.
  - a. terminates
  - b. cancels out
  - c. overrides
  - d. short circuits
9. The \_\_\_\_\_ declares that a derived class is allowed to override a method.
  - a. `void` keyword
  - b. `protected` keyword
  - c. `base` keyword
  - d. `virtual` keyword
10. The \_\_\_\_\_ declares that this method overrides a method in the base class.
  - a. `override` keyword
  - b. `class` keyword
  - c. `virtual` keyword
  - d. `base` keyword
11. A class that is not intended to be instantiated, but used only as a base class, is called a(n) \_\_\_\_\_.
  - a. dummy class
  - b. subclass
  - c. virtual class
  - d. abstract class
12. To declare a class as abstract, you use the \_\_\_\_\_ in the class header.
  - a. `abstract` keyword
  - b. `base` keyword
  - c. `void` keyword
  - d. `virtual` keyword
13. A regular, nonabstract class is sometimes called a \_\_\_\_\_.
  - a. true class
  - b. model class
  - c. concrete class
  - d. real class
14. A(n) \_\_\_\_\_ is a method that appears in a base class but expects to be overridden in a derived class.
  - a. abstract method
  - b. virtual method
  - c. concrete method
  - d. base method
15. A(n) \_\_\_\_\_ is a property that appears in a base class but expects to be overridden in a derived class.
  - a. virtual property
  - b. concrete property
  - c. base property
  - d. abstract property
16. \_\_\_\_\_ allows a base class reference variable to reference a derived class object.
  - a. Polymorphism
  - b. Inheritance
  - c. Generalization
  - d. Specialization

**True or False**

1. The base class inherits fields, properties, and methods from the derived class.
2. Polymorphism allows a class variable of the base class type to reference objects of either the base class or the derived class types.
3. Properties in a base class cannot be overridden in the same way that methods can be overridden.
4. A base class reference variable can reference an object of any class that is derived from the base class.
5. A statement that tries to use the `new` operator to instantiate an abstract class will not compile.
6. A class that is not intended to be instantiated, but used only as a base class, is called a concrete class.
7. When an abstract property appears in a class, it must be overridden in any class that is derived from the class.

**Short Answer**

1. What does a derived class inherit from its base class?
2. Look at the following code, which is the first line of a class declaration. What is the name of the base class? What is the name of the derived class?

```
class Tiger : Felis
```

3. Can methods in the derived class directly access the base class's private members?
4. When you create an instance of a derived class, which constructor is called first?
5. In what kind of situation would you want to use an abstract class instead of a base class?
6. What is primary difference between an abstract class and a regular class?
7. Can abstract classes also contain abstract properties?

**Algorithm Workbench**

1. Write the first line of the definition for a `Poodle` class. The class should be derived from the `Dog` class.
2. Look at the following class declarations:

```
class Plant
{
    public virtual void Message()
    {
        MessageBox.Show("I'm a plant.");
    }
}
class Tree : Plant
{
    public override void Message()
    {
        MessageBox.Show("I'm a tree.");
    }
}
```

Given these class definitions, what will the following code display?

```
Plant p = new Tree();
p.Message();
```

3. Write a parameterized constructor for a base class named `Movie` with a `string` field named `_title` and an `int` field named `_runningTime`.
4. A class named `wave` has a virtual property named `Frequency`. A class named `Sound` is derived from the `wave` class. Write example code showing how the `Frequency` property might appear in the `Sound` class.
5. Create an abstract class called `Star`. Include an abstract method named `SolarMasses` that returns a value of the `double` data type.

## Programming Problems

### 1. `Employee` and `ProductionWorker` Classes

Create an `Employee` class that has properties for the following data:

- Employee name
- Employee number

Next, create a class named `ProductionWorker` that is derived from the `Employee` class. The `ProductionWorker` class should have properties to hold the following data:

- Shift number (an integer, such as 1, 2, or 3)
- Hourly pay rate

The workday is divided into two shifts: day and night. The `Shift` property will hold an integer value representing the shift that the employee works. The day shift is shift 1 and the night shift is shift 2.

Create an application that creates an object of the `ProductionWorker` class and lets the user enter data for each of the object's properties. Retrieve the object's properties and display their values.

### 2. `ShiftSupervisor` Class

In a particular factory, a shift supervisor is a salaried employee who supervises a shift. In addition to a salary, the shift supervisor earns a yearly bonus when his or her shift meets production goals. Create a `ShiftSupervisor` class that is derived from the `Employee` class you created in Programming Problem 1. The `ShiftSupervisor` class should have a property that holds the annual salary and a property that holds the annual production bonus that a shift supervisor has earned. Demonstrate the class in an application.

### 3. `TeamLeader` Class

In a particular factory, a team leader is an hourly paid productionworker that leads a small team. In addition to hourly pay, team leaders earn a fixed monthly bonus. Team leaders are required to attend a minimum number of hours of training per year. Design a `TeamLeader` class that is derived from the `ProductionWorker` class you created in Programming Problem 1. The `TeamLeader` class should have properties for the monthly bonus amount, the required number of training hours, and the number of training hours that the team leader has attended. Demonstrate the class in an application.

### 4. `Person` and `Customer` Classes

Design a class named `Person` with properties for holding a person's name, address, and telephone number. Next, design a class named `Customer`, which is derived from the `Person` class. The `Customer` class should have a property for a customer number and a Boolean property indicating whether the customer wishes to be on a mailing list. Demonstrate an object of the `Customer` class in a simple application.



VideoNote

Solving the  
Employee  
and  
Production-  
Worker  
Classes  
Problem



### 5. PreferredCustomer Class

A retail store has a preferred customer plan where customers can earn discounts on all their purchases. The amount of a customer's discount is determined by the amount of the customer's cumulative purchases in the store as follows:

- When a preferred customer spends \$500, he or she gets a 5 percent discount on all future purchases.
- When a preferred customer spends \$1,000, he or she gets a 6 percent discount on all future purchases.
- When a preferred customer spends \$1,500, he or she gets a 7 percent discount on all future purchases.
- When a preferred customer spends \$2,000 or more, he or she gets a 10 percent discount on all future purchases.

Design a class named `PreferredCustomer`, which is derived from the `Customer` class you created in Programming Problem 4. The `PreferredCustomer` class should have properties for the amount of the customer's purchases and the customer's discount level. Demonstrate the class in a simple application.

## TOPICS

- |  |   |
|--|---|
| 11.1 Introduction to Database Management Systems | 11.5 Connecting to an Existing Database and Using Details View Controls |
| 11.2 Tables, Rows, and Columns                   | 11.6 More about Data-Bound Controls                                     |
| 11.3 Creating a Database in Visual Studio        | 11.7 Selecting Data with the SQL <code>Select</code> Statement          |
| 11.4 The <code>DataGridView</code> Control       |   |

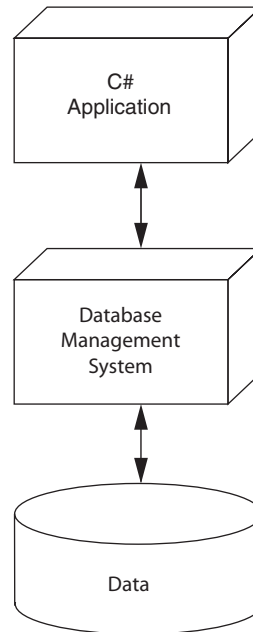
## 11.1 Introduction to Database Management Systems

**CONCEPT:** A database management system (DBMS) is software that manages large collections of data.

If an application needs to store only a small amount of data, traditional files work well. These types of files are not practical, however, when a large amount of data must be stored and manipulated. Many businesses keep hundreds of thousands—or even millions—of data items in files. When a traditional file contains this much data, simple operations such as searching, inserting, and deleting become cumbersome and inefficient.

When developing applications that work with an intensive amount of data, most developers prefer to use a database management system. A **database management system (DBMS)** is software that is specifically designed to store, retrieve, and manipulate large amounts of data in an organized and efficient manner. Once the data is stored using the database management system, applications may be written in C# or other languages to communicate with the DBMS. Rather than retrieving or manipulating the data directly, applications can send instructions to the DBMS. The DBMS carries out those instructions and sends the results back to the application, as Figure 11-1 illustrates.

Although Figure 11-1 is simplified, it illustrates the layered nature of an application that works with a DBMS. The topmost layer of software, which—in this case—is written in

**Figure 11-1** A C# application interacting with a DBMS, which manipulates data

C#, interacts with the user. It also sends instructions to the next layer of software, the DBMS. The DBMS works directly with the data and sends the results of operations back to the application.

For example, suppose a company keeps all its product records in a database. The company has a C# application that allows the user to look up information on any product by entering its product ID number. The C# application instructs the DBMS to retrieve the record for the product with the specified product ID number. The DBMS retrieves the product record and sends the data back to the C# application. The C# application displays the data to the user.

The advantage of this layered approach to software development is that the C# programmer does not need to know about the physical structure of the data. He or she needs to know only how to interact with the DBMS. The DBMS handles the actual reading of, writing of, and searching for data.

## SQL Server Express Edition

There are numerous DBMSs in use today, and Visual C# can interact with many of them. Some of the more popular ones are Microsoft SQL Server, Oracle, DB2, MySQL, and Microsoft Access. In this book we use Microsoft SQL Server Express Edition because it is automatically installed on your system when you install Visual Studio or Visual Studio Express.

### Checkpoint

- 11.1 What is a database management system (DBMS)?
- 11.2 Why do most businesses use a DBMS to store their data instead of creating their own text files to hold the data?
- 11.3 When developing a C# application that uses a DBMS to store and manipulate data, why doesn't the programmer need to know specific details about the physical structure of the data?

## 11.2 Tables, Rows, and Columns

**CONCEPT:** Data that is stored in a database is organized into tables, rows, and columns.

A database management system stores data in a **database**. The data that is stored in a database is organized into one or more tables. Each **table** holds a collection of related data. The data that is stored in a table is then organized into rows and columns. A **row** is a complete set of information about a single item. The data that is stored in a row is divided into columns. Each **column** holds an individual piece of information about the item.

For example, suppose we are developing a phone book application and we want to store a list of names and phone numbers in a database. We initially store the following list:

Katie Allen	555-1234
Jill Ammons	555-5678
Kevin Brown	555-9012
Elisa Garcia	555-3456
Jeff Jenkins	555-7890
Leo Killian	555-1122
Marcia Potemkin	555-3344
Kelsey Rose	555-5566

Think about how this data would appear if we stored it as rows and columns in a spreadsheet. We would put the names in one column and the phone numbers in another column. Each row, then, would contain data about one person. Figure 11-2 shows how the third row contains the name and phone number for Kevin Brown.

**Figure 11-2** The table

Name	Phone
Katie Allen	555-1234
Jill Ammons	555-5678
Kevin Brown	555-9012
Elisa Garcia	555-3456
Jeff Jenkins	555-7890
Leo Killian	555-1122
Marcia Potemkin	555-3344
Kelsey Rose	555-5566

This row contains data about one person:  
**Name: Kevin Brown**  
**Phone: 555-9012**

When we create a database table to hold this information, we organize it in a similar manner. We give the table a name, such as `Person`. In the table, we create a column for the names and a column for the phone numbers. Each column in a table must have a name, so we can name our columns `Name` and `Phone`, respectively.

### Column Data Types

When you create a database table, you must specify a data type for the columns. The data types that you can choose from are not C# data types, however. They are the data types

that are provided by the DBMS. In this book we are using Microsoft SQL Server, so we will select from the data types provided by that DBMS. Table 11-1 lists a few of the Microsoft SQL Server data types and shows the C# data type with which each is generally compatible.



**NOTE:** Table 11-1 shows the data types that you will most often use while learning. These are only a small number of the data types provided by Microsoft SQL Server, however.

**Table 11-1** A few of the Microsoft SQL Server data types

SQL Server Data Type	Description	Corresponding C# or .NET Framework Data Type
bit	True/false values	bool
datetime	A date and a time	DateTime
decimal( <i>t</i> , <i>d</i> )	A decimal value with <i>t</i> total digits and <i>d</i> digits appearing after the decimal point.	decimal
float	Real numbers	double
int	An integer number	int
money	Values that represent currency	decimal
nchar( <i>n</i> )	A fixed-length Unicode string with a maximum length of <i>n</i> characters.	string
nvarchar( <i>n</i> )	A variable-length Unicode string with a maximum length of <i>n</i> characters.	string



**NOTE:** The nchar(*n*) and nvarchar(*n*) data types are both used to store strings. An nchar(*n*) column is fixed in length and will always use *n* characters of space in the database. An nvarchar(*n*) column is variable in length, and the amount of space it uses in the database will be enough to accommodate the piece of data it holds, up to *n* characters.

## Primary Keys

Most database tables have a **primary key**, which is a column that can be used to identify a specific row. The column that is designated as the primary key must hold a unique value for each row. Here are some examples:

- A table stores employee data, and one of the columns holds employee ID numbers. Because each employee's ID number is unique, this column can be used as the primary key.
- A table stores product data, and one of the columns holds the product number. Because each product has a unique product number, this column can be used as the primary key.
- A table stores invoice data, and one of the columns holds invoice numbers. Each invoice has a unique invoice number, so this column can be used as a primary key.

## Identity Columns

Sometimes the data that you want to store in a table does not contain any unique items that can be used as a primary key. For example, in the `Person` table that we previously described, neither the `Name` column nor the `Phone` column contains unique data. Two people can have the same name, so it is possible that a name might appear more than once in the `Name` column. Also, multiple people can share the same phone number, so it is possible that a phone number might appear more than once in the `Phone` column. Consequently, you cannot use the `Name` column or the `Phone` column as a primary key.

In a case such as this, it is necessary to create an identity column specifically to serve as the primary key. An **identity column** is a column that contains unique values that are generated by the DBMS. Identity columns typically contain integers. Each time a new row is added to the table, the DBMS automatically assigns a unique value to that row's identity column.

For example, when designing the `Person` table that we previously discussed, we could create an `int` column named `PersonID` and designate that column as an identity column. (As a result, the DBMS assigns a unique integer value to the `PersonID` column for each row.) Then we could designate the `PersonID` column as the table's primary key. Figure 11-3 shows an example of the `Person` table after we have created it and entered data into it.

**Figure 11-3** The `Person` table with data entered

PersonID	Name	Phone
1	Katie Allen	555-1234
2	Jill Ammons	555-5678
3	Kevin Brown	555-9012
4	Elisa Garcia	555-3456
5	Jeff Jenkins	555-7890
6	Leo Killian	555-1122
7	Marcia Potemkin	555-3344
8	Kelsey Rose	555-5566

## Allowing Null Values

If a column contains no data, it is said to be null. Sometimes it is okay for a column to be left empty. Some columns, however, such as primary keys, must contain a value. When you are designing a table, you can specify whether a column is allowed to be null. If a particular column is not allowed to be null, any time you add a row of data to the table, the DBMS will require that a value be provided for the column. Leaving the column empty results in an error.



### Checkpoint

11.4 Describe each of the following terms:

- a. database
- b. table
- c. row
- d. column

11.5 Match the Microsoft SQL Server data type with the compatible C# data type.

- |             |             |
|-------------|-------------|
| 1. bit      | a. double   |
| 2. datetime | b. int      |
| 3. float    | c. bool     |
| 4. int      | d. DateTime |
| 5. money    | e. string   |
| 6. nchar    | f. decimal  |

11.6 What is the purpose of a primary key?

11.7 What is an identity column?

11.8 If a particular column is not allowed to be null, what is the result if the column is left empty?

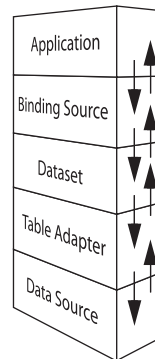
## 11.3 Creating a Database in Visual Studio

**CONCEPT:** A .NET application uses several components, arranged in layers, to connect to a database. Visual Studio provides tools that allow you to create a database and configure the various components that an application needs to connect to it.

### Connecting an Application to a Database

A .NET application requires a set of special components that let it connect to, and work with, a database. The components are layered one on top of the other, as shown in Figure 11-4.

**Figure 11-4** The components used by an application to connect to a database



Here is a summary of the layers shown in the figure:

- **Data Source**—As its name implies, a **data source** is a source of data with which the application can work. Data sources are usually databases, but they can also be Excel spreadsheets, XML data, text files, or Web services.
- **Table Adapter**—A **table adapter** connects to a data source and can retrieve data from a table in a data source. It can also update the table in the data source.
- **Dataset**—A **dataset** gets a copy of a table from the table adapter and keeps the copy of the table in memory. Instead of working directly with the database, the application works with the dataset, modifying rows, deleting rows, adding new rows, etc. Then, the dataset can instruct the table adapter to write the changes back to the database.
- **Binding Source**—A **binding source** is a component that can connect user interface controls directly to a dataset.

Fortunately, Visual Studio provides wizards that make it easy to create and configure the necessary components. In Tutorial 11-1 you start a new C# project and use Visual Studio to perform the following:

- Create an SQL Server database
- Design a table in the database
- Add data to the table



VideoNote

**Tutorial 11-1:**  
Starting the *Phone Book* Application and Creating the *Phonelist.mdf* Database

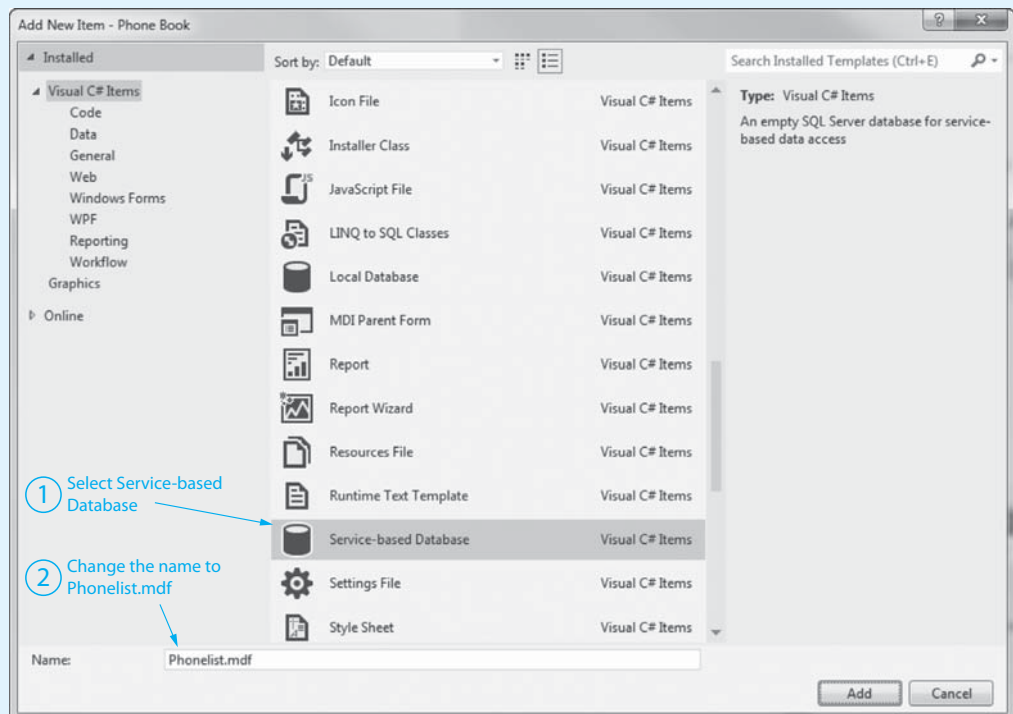
## Tutorial 11-1:

### Starting the *Phone Book* Application and Creating the *Phonelist.mdf* Database

In the next two tutorials, you create an application that uses a database to store a list of names and phone numbers. In this tutorial you start the application by creating the database. In the next tutorial you connect the application to the database, add a dataset, and add a control to the form that allows the user to interact with the database.

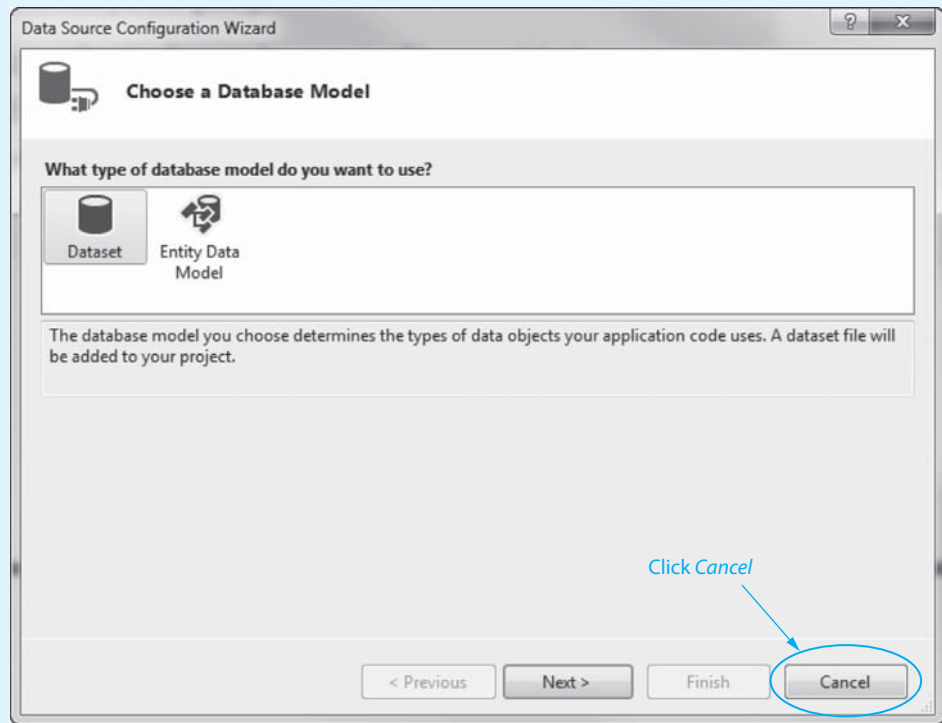
- Step 1:** Start Visual Studio (or Visual Studio Express). Create a new *Windows Forms Application* project named *Phone Book*.
- Step 2:** Change the Form1 form's Text property to *Phone Book*.
- Step 3:** Next you create a new database and add it to the project. Click *PROJECT* on the Visual Studio menu bar and then select *Add New Item...*
- Step 4:** The *Add New Item* window will appear. Scroll down the list of items and select *Service-based Database*, as shown in Figure 11-5. You also need to specify the database's name in the *Name* text box at the bottom of the window. A default name, such as *Database1.mdf* appears there. Change the name to *Phonelist.mdf*. (Be sure to keep the .mdf file extension.)

**Figure 11-5** The *Add New Item* window



- Step 5:** Click the *Add* button in the *Add New Item* window. This adds an empty SQL Server database named *Phonelist.mdf* to your project.
- Step 6:** The *Data Source Configuration Wizard* window, shown in Figure 11-6, appears next. Click the *Cancel* button. (You are canceling the process at this point because the database that you just created is currently empty. You cannot configure a data source until you have created a database table.)

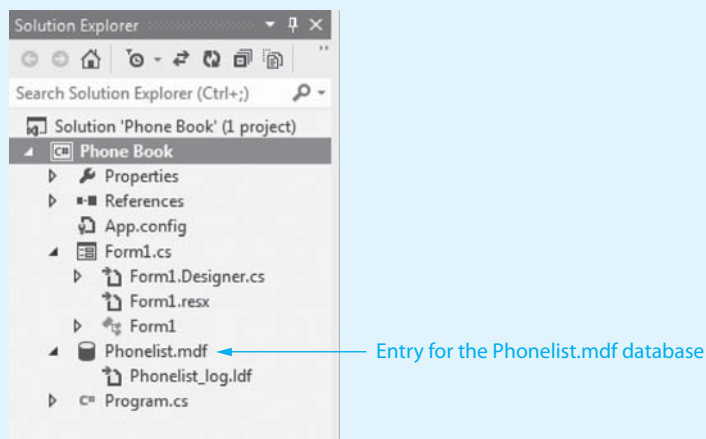


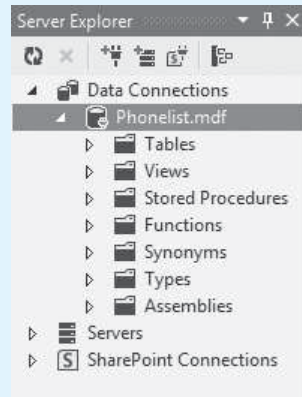
**Figure 11-6** Clicking *Cancel* in the *Data Source Configuration Wizard* window

**Step 7:** Look at the *Solution Explorer*, shown in Figure 11-7, and notice that it now contains an entry for the *Phonelist.mdf* database. Double-click the entry for *Phonelist.mdf* database. Notice that a new window named *Server Explorer* is now open in the area where the *Toolbox* is located. (The window is named *Server Explorer* in Visual Studio. If you are using Visual Studio Express, the window is named *Database Explorer*.) The *Server Explorer* is shown in Figure 11-8.

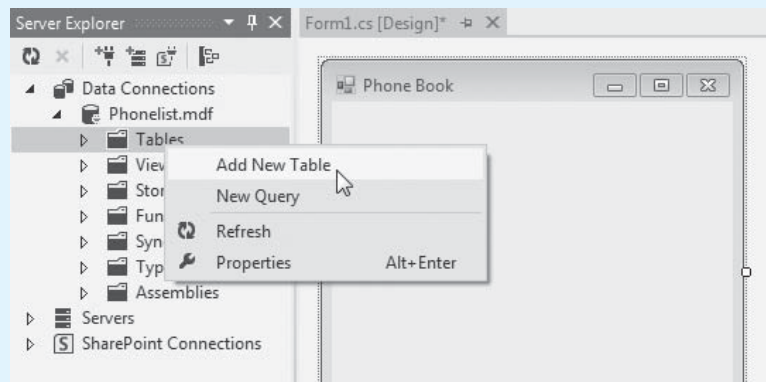


**NOTE:** For our purposes, it does not matter whether you are using the *Server Explorer* in Visual Studio or the *Database Explorer* in Visual Studio Express. They both work the same way. The *Server Explorer* provides the added capability to locate databases across your network.

**Figure 11-7** *Solution Explorer* entry for the *Phonelist.mdf* database

**Figure 11-8** *Server Explorer*

**Step 8:** Now you add a table to the Phonelist.mdf database. In the *Server Explorer* (or *Database Explorer*), make sure the Phonelist.mdf entry is expanded, as shown in Figure 11-8. Right-click on *Tables*, and as shown in Figure 11-9, click *Add New Table* on the menu.

**Figure 11-9** Adding a table to the Phonelist.mdf database

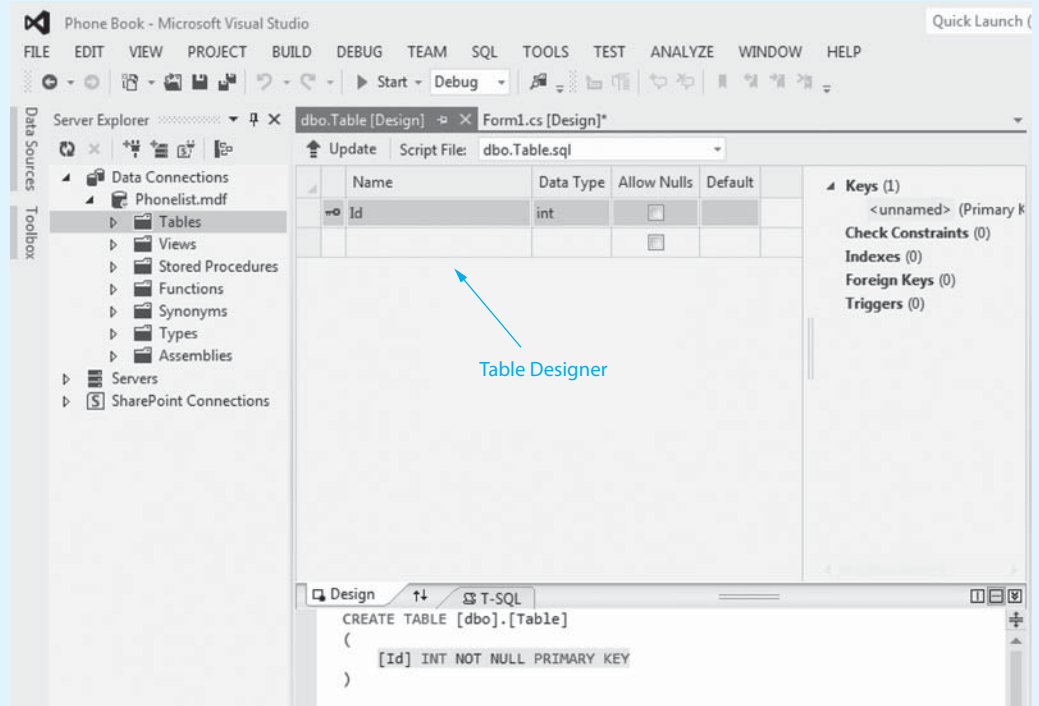
This displays the *Table Designer*, as shown in Figure 11-10. You use the *Table Designer* to specify the names and data types of the table's columns.

**Step 9:** Look closely at the *Table Designer* and notice that a column named `Id` has automatically been added to the table. Figure 11-11 shows how to read the information about the column in the *Table Designer*:

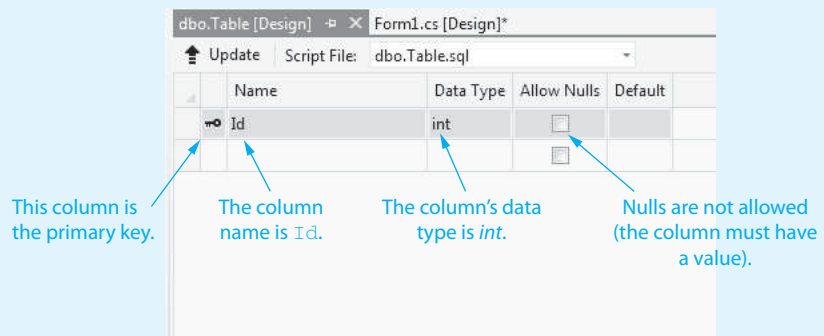
- The key icon (⌨) that appears to the left of the name indicates that the column is the table's primary key.
- The name of the column is `Id`.
- The column's data type is `int`.
- The *Allow Nulls* checkbox is not checked. This means that the column must have a value (it cannot be null).

We want to keep this column, but we are going to make some changes to it. In the next step we will change the column's name to `PersonID`, and we will make it an identity column (so the database will automatically generate unique integer values for it).

**Figure 11-10** The *Table Designer*



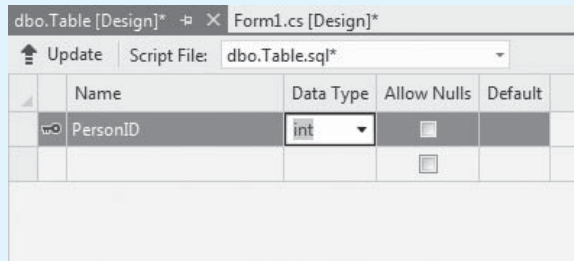
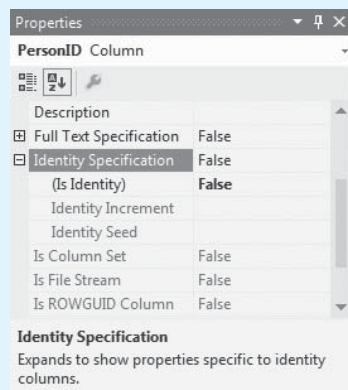
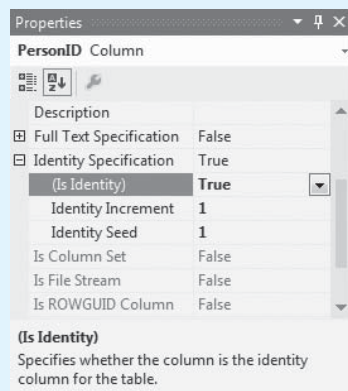
**Figure 11-11** The `Id` column that is automatically added to the table



**Step 10:** Click on the column name (`Id`) in the *Table Designer*, and change the name to `PersonID`. Press the `Tab` key. The *Table Designer* should appear as shown in Figure 11-12.

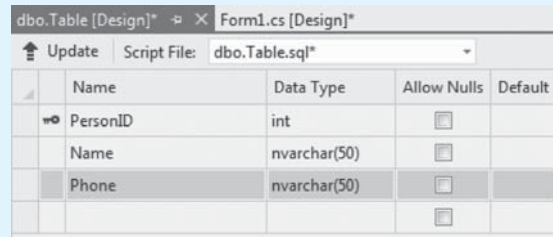
**Step 11:** With the column still selected, notice that the *Properties* window is showing the column's properties. Scroll down until you see *Identity Specification*. Double-click *Identity Specification*, and you should see the (*Is Identity*), *Identity Increment*, and *Identity Seed* properties appear below it, as shown in Figure 11-13.

**Step 12:** Change the (*Is Identity*) property to *True*. This designates the column as an identity column. Notice that the *Identity Increment* and *Identity Seed* properties are both now set to *1*, as shown in Figure 11-14. Leave these values as they are.

**Figure 11-12** The column name changed to *PersonID***Figure 11-13** The column's *Identity Specification* properties displayed**Figure 11-14** The *Identity Specification* properties set to the desired values

**Step 13:** In the *Table Designer*, add another column named *Name*. Select *nvarchar(50)* as the data type and remove the check under *Allow Nulls*.

**Step 14:** Add another column named *Phone*. Select *nvarchar(50)* as the data type and remove the check under *Allow Nulls*. The *Table Designer* should now appear as shown in Figure 11-15.

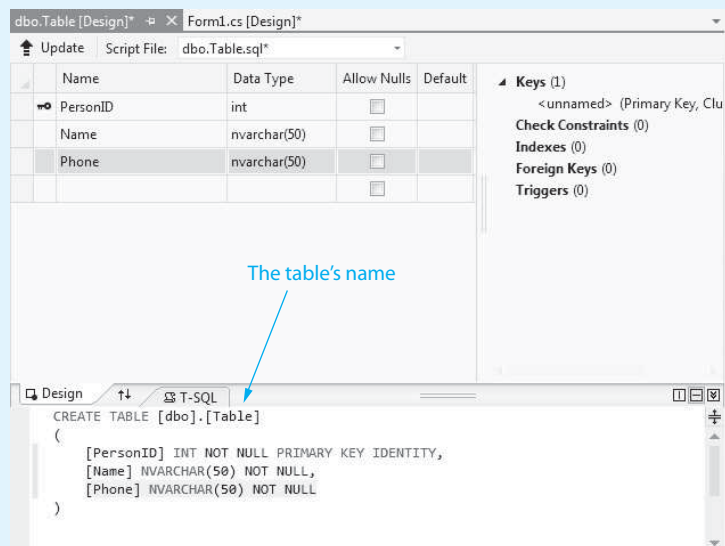
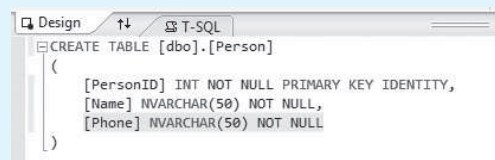
**Figure 11-15** The `PersonID`, `Name`, and `Phone` columns created in the *Table Designer*


Name	Data Type	Allow Nulls	Default
PersonID	int	<input type="checkbox"/>	
Name	nvarchar(50)	<input type="checkbox"/>	
Phone	nvarchar(50)	<input type="checkbox"/>	

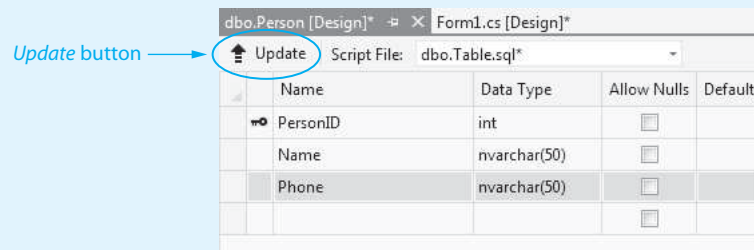
**Step 15:** You are finished designing the table, but you need to change the table's name. When you create a new table in the *Server Explorer*, it is given a default name, such as `Table`. Notice at the bottom of the screen (below the *Table Designer*), you see an area labeled *T-SQL*. As shown in Figure 11-16, the first statement in this window shows the name of the table. Change the first statement so it reads as follows:

```
CREATE TABLE [dbo].[Person]
```

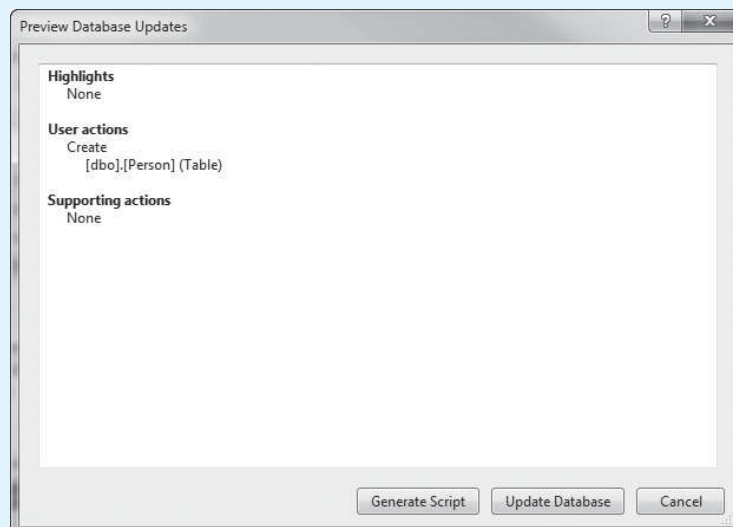
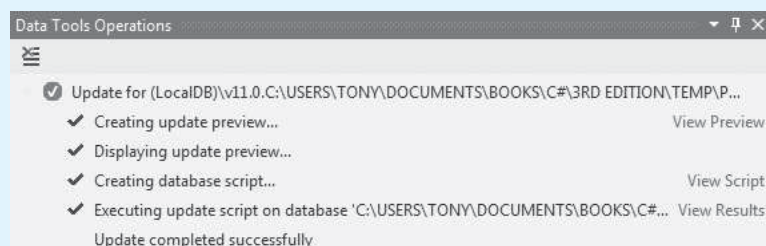
The *T-SQL* window should now appear as shown in Figure 11-17.

**Figure 11-16** The *T-SQL* window**Figure 11-17** The table named changed to `Person`

**Step 16:** Although you changed the table's name in the *T-SQL* window, the change does not take effect until you update the database. Click the *Update* button that appears in the upper left corner of the *Table Designer*, as shown in Figure 11-18.


**Figure 11-18** The *Update* button to update the database

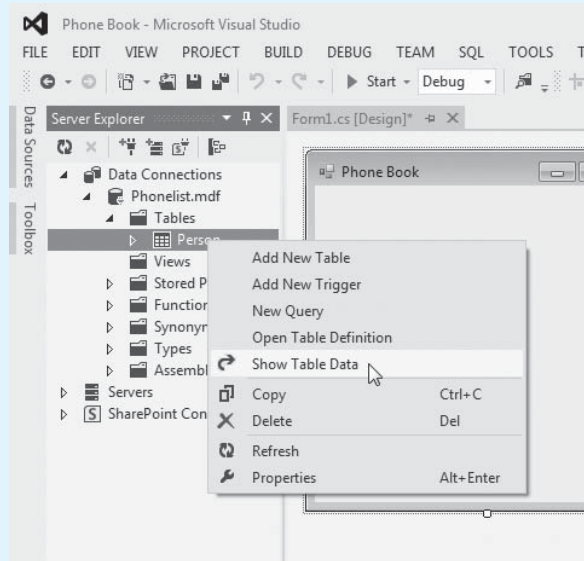
**Step 17:** The *Preview Database Updates* window, shown in Figure 11-19, will appear next. Click the *Update Database* button. After a moment you should see confirmation that the update was successful at the bottom of the screen, similar to that shown in Figure 11-20. Close the *Table Designer* window.

**Figure 11-19** The *Preview Database Updates* window**Figure 11-20** Confirmation that the database was updated

**Step 18:** The next step is to enter data into the table. In the *Server Explorer* (or *Database Explorer*), expand the *Tables* entry and then right-click the *Person* entry. You will see the pop-up menu shown in Figure 11-21. Click *Show Table Data* in the menu.



**NOTE:** If you do not see the entry for the `Person` table in the *Server Explorer* (or *Database Explorer*), click the *Refresh* button (  ) in the upper-left corner of the window.

**Figure 11-21** Clicking *Show Table Data*

**Step 19:** The table should now be opened and ready for input, as shown in Figure 11-22. Enter several names and phone numbers into the Name and the Phone columns. As you enter data, keep the following in mind:

- Do not enter values for the `PersonID` column. The system automatically generates a value for the `PersonID` column each time you add a new row.
- You must enter values for the `Name` and `Phone` columns. Recall that you removed the check from *Allow Nulls* for these columns when you designed the table. If you try to move away from a row without specifying values for these columns, you will see an error message.
- Exclamation points will appear next to the columns as you enter data. These simply mean that the data has not been saved to the database. When you move away from the row, the data is saved and the exclamation points disappear.

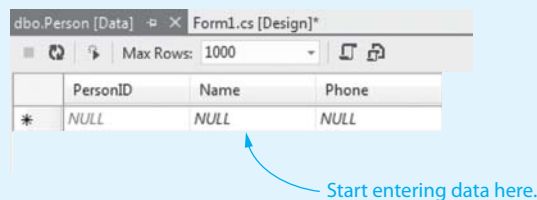
**Figure 11-22** Ready to enter data into the *Person* Table

Figure 11-23 shows the table with sample data entered.

**Step 20:** Once you have entered all the data, click *FILE* on the Visual Studio menu and then click *Save All*. The rows are saved to the `Phonelist.mdf` database.

**Step 21:** Close the table so the `Form1` form is displayed in the *Designer*.

Let's review what you have done up to this point:

- Created an SQL Server database named `Phonelist.mdf`
- Designed and created a table named `Person`
- Entered sample data into the table

**Figure 11-23** Sample data entered into the Person Table

	PersonID	Name	Phone
	1	Katie Allen	555-1234
	2	Jill Ammons	555-5678
	3	Kevin Brown	555-9012
	4	Elisa Garcia	555-3456
	5	Jeff Jenkins	555-7890
	6	Leo Killian	555-1122
	7	Marcia Potemkin	555-3344
	8	Kelsey Rose	555-5566
	9	Natalie Smith	555-2345
▶▶	NULL	NULL	NULL

In the next tutorial you connect the Phonelist.mdf database to the application’s form and add a control to the form that lets the user interact with the database. If you intend to continue to the next tutorial at this time, leave the project open in Visual Studio.

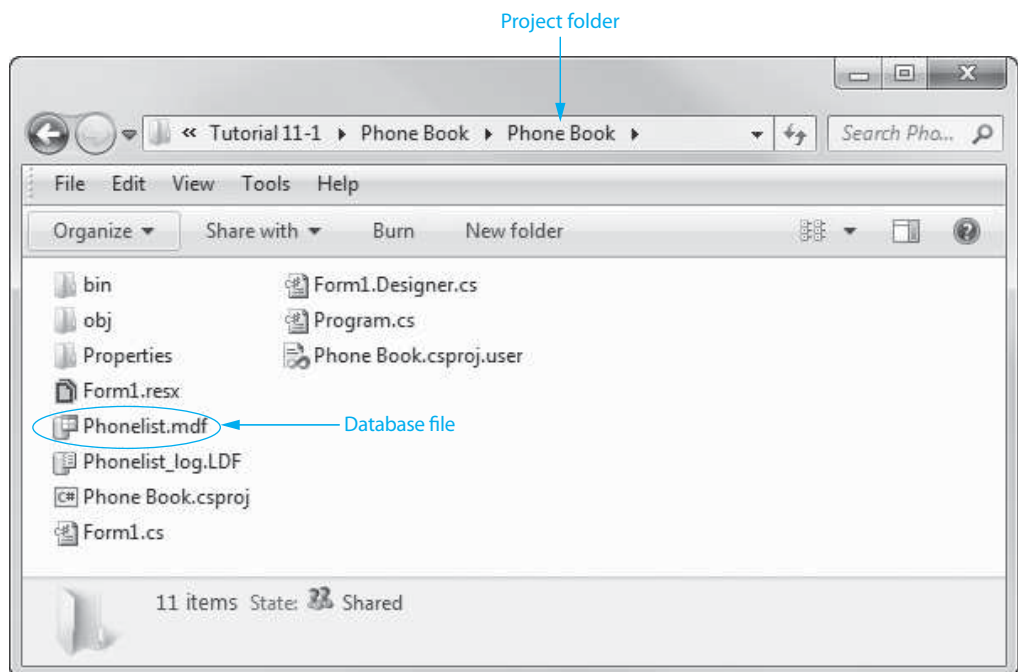
### The Database File’s Location

When you use Visual Studio to create a database, as you did in Tutorial 11-1, the database file will be created in the project folder. For example, Figure 11-24 shows how the Phonelist.mdf database file was created in the *Phone Book* application’s project folder.



**NOTE:** When you create an SQL Server database, you will also see a file that ends with the .LDF extension. For example, in Figure 11-24 you see a file named Phonelist\_log.LDF. This is a transaction log file. The SQL Server DBMS uses it to keep a log of all the operations that you perform on the database.

**Figure 11-24** Location of the Phonelist.mdf database file







## Checkpoint

- 11.9 List each of the .NET components that allow an application to connect to, and work with, a database in the order they are layered. Begin the list with the application as the topmost layer.
- 11.10 What is the relationship between the table adapter and data source components?
- 11.11 What component is used to connect interface controls to a dataset?

## 11.4 The DataGridView Control

**CONCEPT:** A DataGridView control can display a database table in a scrollable grid.

A **data-bound control** is a user interface control that is connected to a data source. For example, a data-bound control can be connected to a column in a database table. Data-bound controls automatically display data from the data source and can be used to change the data that they are bound to. One of the simplest and most powerful data-bound controls is the DataGridView control. A **DataGridView control** can display an entire database table in a scrollable grid on an application's form.

In Tutorial 11-2 you continue working on the *Phone Book* application that you started in Tutorial 11-1. You connect the application's form to the *Phonelist.mdf* database and add a DataGridView control that can be used to view and update the *Person* table.



### Tutorial 11-2:

#### Completing the *Phone Book* Application

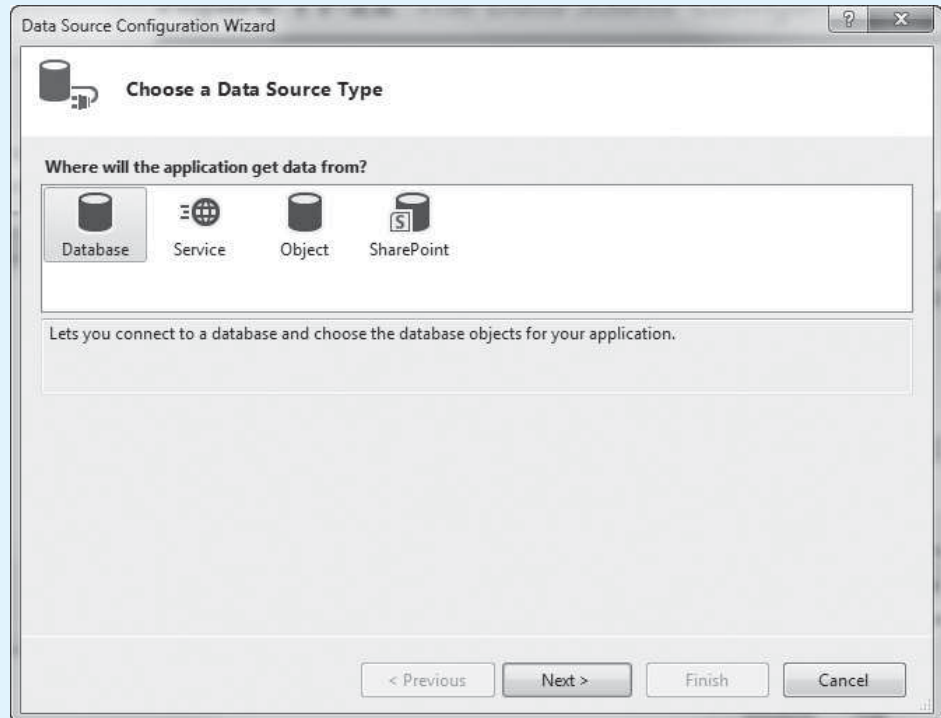
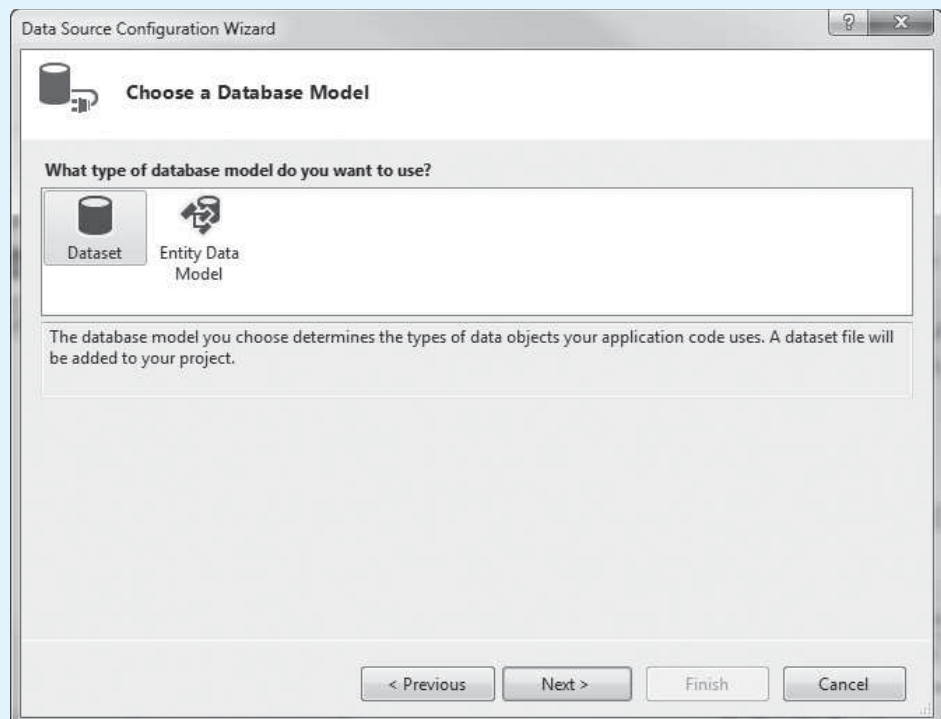


VideoNote

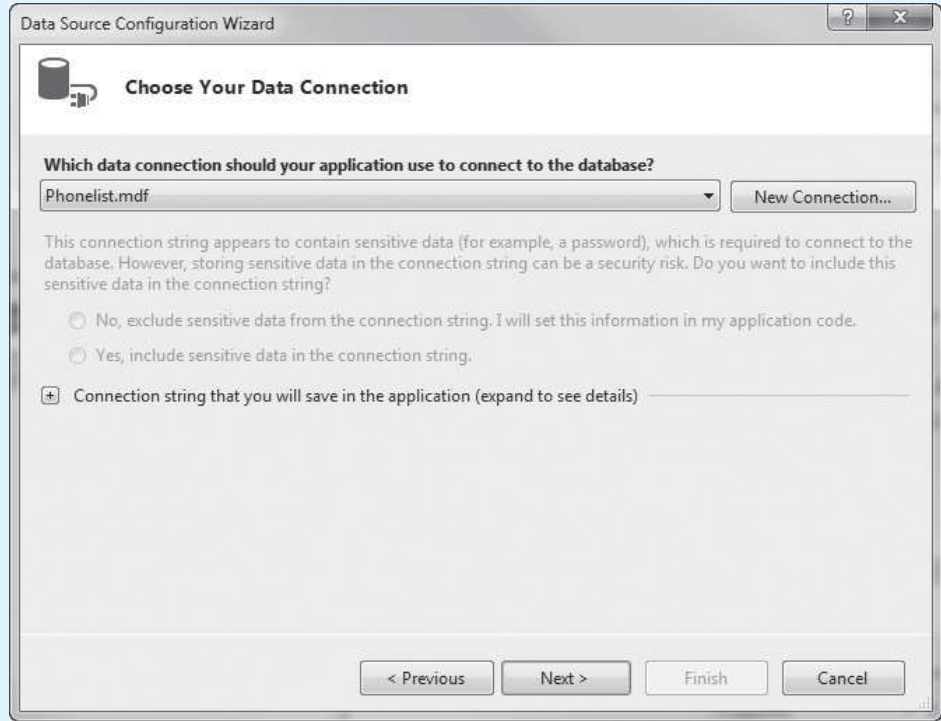
**Tutorial 11-2:**  
Completing  
the *Phone  
Book*  
Application

In this tutorial you complete the *Phone Book* application. You add the *Phonelist.mdf* database to the project as a data source, create a dataset that is connected to the *Person* table, and add a DataGridView control that lets the user interact with the database.

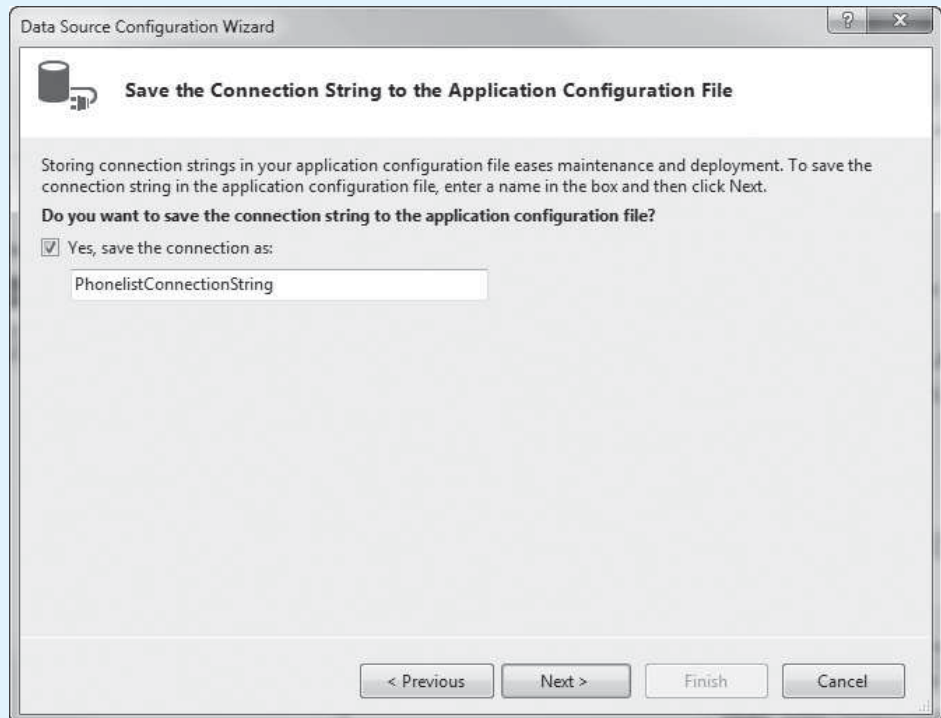
- Step 1:** Make sure the *Phone Book* project is open in Visual Studio (or Visual Studio Express) from the previous tutorial.
- Step 2:** Click *PROJECT* on the Visual Studio menu and then click *Add New Data Source*. . . . You should see the *Data Source Configuration Wizard*, as shown in Figure 11-25.
- Step 3:** The data source you are adding is a database, so make sure *Database* is selected and then click *Next >*. The window now appears, as shown in Figure 11-26.
- Step 4:** Make sure *Dataset* is selected, and click *Next >*. The window now appears, as shown in Figure 11-27.
- Step 5:** In this window you are asked to choose a data connection, and the *Phonelist.mdf* database should be automatically selected, as shown in Figure 11-27. Simply click *Next >*. The window now appears, as shown in Figure 11-28.

**Figure 11-25** The *Data Source Configuration Wizard—Choose a Data Source Type***Figure 11-26** The *Data Source Configuration Wizard—Choose a Database Model*

**Figure 11-27** The *Data Source Configuration Wizard—Choose Your Data Connection*



**Figure 11-28** The *Data Source Configuration Wizard—Save the Connection String*



**Step 6:** In this window you are asked if you want to save a connection string. Leave the *Yes* box checked and click *Next >*.

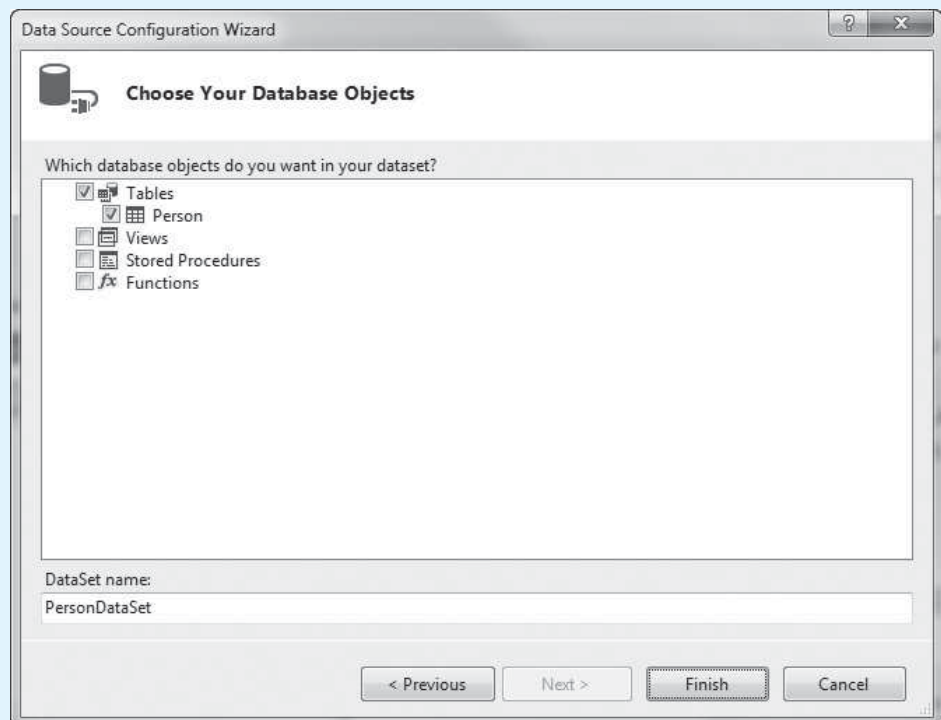
**Step 7:** In the window that appears now, you are asked to choose the database objects that you want to include in the dataset. Expand the *Tables* entry, and place a check next to *Person*, as shown in Figure 11-29.

At the bottom of the window you can specify a name for the dataset. The default name `PhonelistDataSet` is already provided. Because you selected the `Person` table as the database object, change the dataset name to `PersonDataSet`. Click *Finish*.

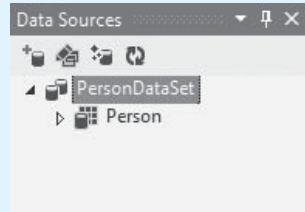
Here is a summary of what you just did:

- You added the `Phonelist.mdf` database as a data source to the application.
- You created a dataset component that is connected to the `Person` table. The name of the dataset component is `PersonDataSet`.

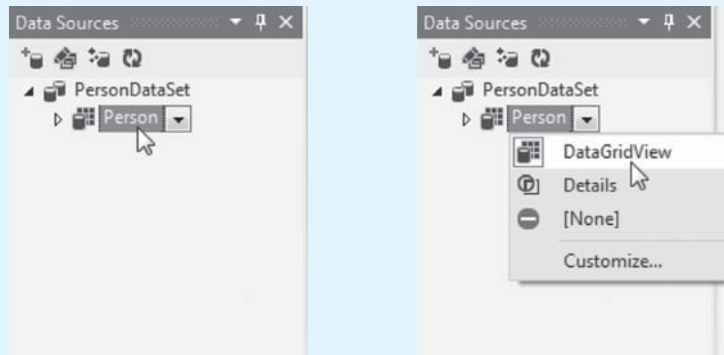
**Figure 11-29** The *Data Source Configuration Wizard—Choose Your Database Objects*



**Step 8:** Visual Studio provides a *Data Sources* window that lets you see all the data sources in the current project. Click *VIEW* on the Visual Studio menu bar, then select *Other Windows*, then click *Data Sources*. The *Data Sources* window should be displayed, as shown in Figure 11-30. Notice that the window shows the name of the dataset, which is `PersonDataSet`, and the name of the table to which the dataset is connected, which is `Person`.

**Figure 11-30** The *Data Sources* window

**Step 9:** Next you select *DataGridView* as the default data-bound control for the `Person` table. In the *Data Sources* window, click the entry for the `Person` table, as shown in the image on the left in Figure 11-31. Then, click the down arrow (▼), and select *DataGridView*, as shown in the image on the right.

**Figure 11-31** Selecting *DataGridView* as the data-bound control for the `Person` table

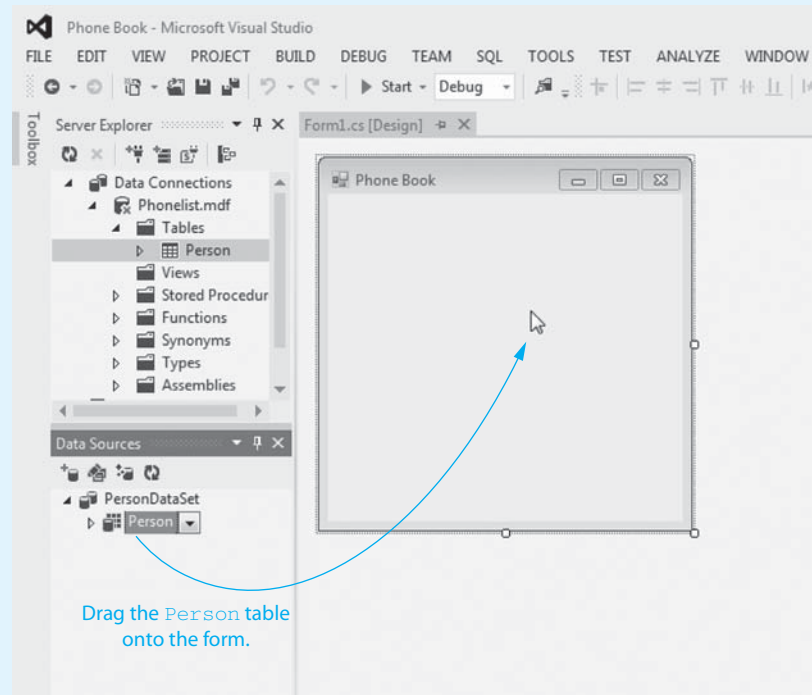
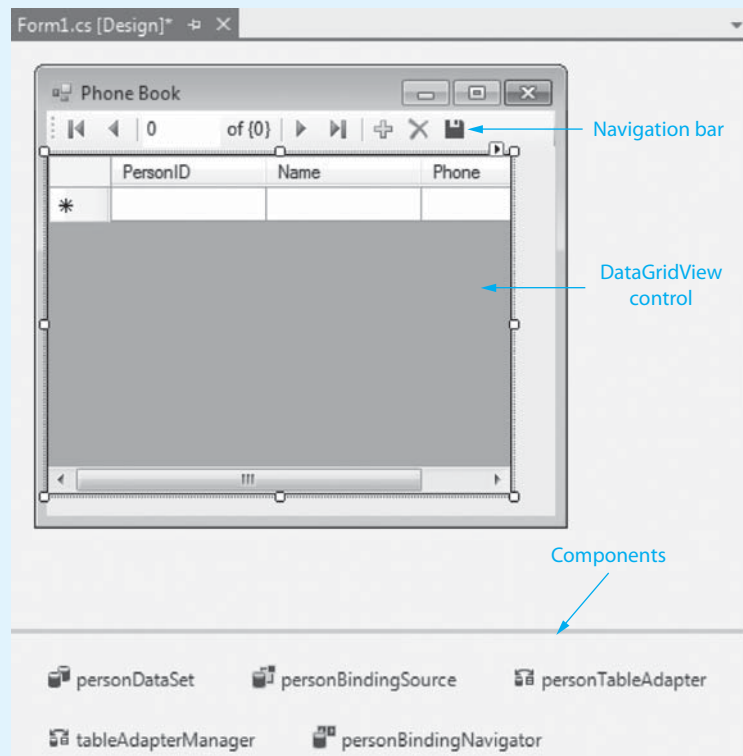
Select *Person*.

Click the down-arrow and select *DataGridView*.

**Step 10:** Now you add a *DataGridView* control to the form. As shown in Figure 11-32, click and drag the `Person` table from the *Data Sources* window onto the form. As shown in Figure 11-33, this creates a *DataGridView* control and a navigation bar on the form. (If necessary, adjust the size of the form and the size and position of the *DataGridView* control so they appear similar to Figure 11-33.)

Notice that the component tray (the gray area at the bottom of the *Designer*) now contains several items. These are components that were automatically created when you placed the *DataGridView* control on the form. Here's a summary of the components:

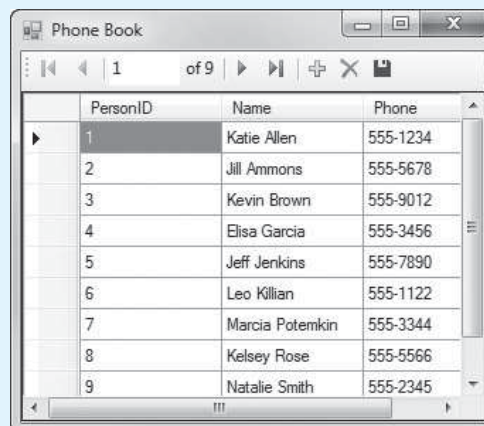
- `personTableAdapter`—This is the table adapter. It gets data directly from the data source, which in this case is the `Person.mdf` database.
- `tableAdapterManager`—In many applications, the database has multiple tables from which we want to get data. A table adapter manager is a component that manages multiple tables.
- `personDataSet`—This is the dataset component. It gets a copy of the table from the table adapter and keeps it in memory. The application works with the dataset instead of working directly with the database.
- `personBindingSource`—This is the navigation bar.

**Figure 11-32** Dragging the `Person` table onto the form**Figure 11-33** The `DataGridView` control placed on the form

**Step 11:** Save and run the application. The form will appear similar to Figure 11-34, with the rows of the `Person` table displayed in the `DataGridView` control. You can use the `DataGridView` control in the following ways:

- To change the value of a cell, click the cell with the mouse and then change its data as necessary.
- To select a row, click the button that appears next to it, along the left side of the control.
- To delete a row, select it; then either click the *Delete* button (X) on the navigation bar or press `Delete` on the keyboard.
- To add a new row, scroll to the bottom of the grid, where you will see an empty row. Enter the new data in the empty row.
- The changes that you make affect only the in-memory copy of the table that is held in the dataset. To save the changes to the database, click the *Save* button (floppy disk) on the navigation bar.
- To sort the rows on a column value, click the column heading.

**Figure 11-34** The *Phone Book* application running



**Step 12:** Use the `DataGridView` control to make several changes to the dataset. For example, change a value in an existing row, add a new row, and delete an existing row. Be sure to click the *Save* button (floppy disk) on the navigation bar to save your changes.

**Step 13:** Close the application and then rerun it to verify that your changes were saved. When you are finished, close the application.

## Auto-Generated Code

When you place a data-bound control, such as the `DataGridView`, on a form, Visual Studio does a lot of work behind the scenes to make the control function. In fact, you completed the application in Tutorial 11-2 without writing a single line of code! If you open the form in the code editor, however, you will see that Visual Studio generated some code, as shown in Program 11-1.

**Program 11-1** Form1 code in the *Phone Book* application

```
1 using System;
2 using System.Collections.Generic;
3 using System.ComponentModel;
4 using System.Data;
5 using System.Drawing;
6 using System.Linq;
7 using System.Text;
8 using System.Threading.Tasks;
9 using System.Windows.Forms;
10
11 namespace Phone_Book
12 {
13     public partial class Form1 : Form
14     {
15         public Form1()
16         {
17             InitializeComponent();
18         }
19
20         private void personBindingNavigatorSaveItem_Click(object sender, EventArgs e)
21         {
22             this.Validate();
23             this.personBindingSource.EndEdit();
24             this.tableAdapterManager.UpdateAll(this.personDataSet);
25
26         }
27
28         private void Form1_Load(object sender, EventArgs e)
29         {
30             // TODO: This line of code loads data into the . . .
31             this.personTableAdapter.Fill(this.personDataSet.Person);
32
33         }
34     }
35 }
```

Visual Studio adds an event handler in lines 20–26 that executes when the user clicks the *Save* button on the navigation bar. In a nutshell, the statements in this method apply any changes that have been made to the DataGridView control to the dataset and then save the dataset to the database.

Visual Studio also adds a Load event handler for the form, in lines 28–33. In line 31, the event handler calls the table adapter’s `Fill` method, passing a reference to the `Person` table (contained in the dataset) as an argument. This statement causes the table adapter to load data from the database into the dataset.

 **Checkpoint**

- 11.12 What do you call a user interface control that is connected to a data source?
- 11.13 List the components that are automatically created when you place a DataGridView control on a form.
- 11.14 What is the purpose of the table adapter’s `Fill` method?
- 11.15 What kind of information is displayed in the *Data Sources* window? How is it displayed?



## 11.5 Connecting to an Existing Database and Using Details View Controls

**CONCEPT:** You can easily connect an application to an existing database. The Details view controls are an alternative to the DataGridView control for interacting with a database.

In Tutorial 11-1 you used Visual Studio to create a database from scratch and populate its table with data. More often, programmers must create applications that connect to existing databases. In Tutorial 11-3 you create an application and connect it to a database that is provided in the Student Sample Program files. The database is named ProductDB.mdf, and you will find it in the *Chap11* folder. The database has one table, named `Product`. Figure 11-35 shows the data that is stored in the `Product` table.

**Figure 11-35** The `Product` table in the ProductDB.mdf database

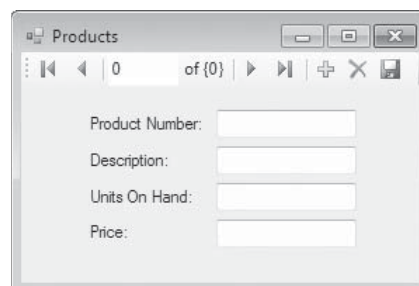
Product_Number	Description	Units_On_Hand	Price
10-01	Oxford Cloth Shirt	100	39.9500
10-02	Poplin Shirt	150	38.5000
10-03	Plaid Flannel Shirt	80	34.7500
10-04	Canvas Shirt	200	32.9500
10-05	Cotton Shirt	250	28.9500
20-01	Chino Classic Fit Pants	100	28.9500
20-02	Chino Relaxed Fit Pants	100	28.9500
20-03	Denim Jeans	275	32.9500
20-04	Wool Trousers	75	78.9500
30-01	Warm-Up Jacket	125	59.9500
30-02	Fleece Pullover	150	28.9500
30-03	Parka	75	199.9500

Here are some things to know about the columns in the `Product` table:

- The `Product_Number` column is the primary key. Its data type is `nchar(5)`, and nulls are not allowed.
- The `Description` column's data type is `nvarchar(50)`, and nulls are not allowed.
- The `Units_On_Hand` column's data type is `int`, and nulls are not allowed.
- The `Price` column's data type is `money`, and nulls are not allowed.

In the tutorial you also learn how to create a Details view. A **Details view** is a set of individual controls that are bound to the columns in a single row. Rather than showing multiple rows at once, a Details view lets the user see one row at a time. Figure 11-36 shows an

**Figure 11-36** Details view



example of a form with a set of Details view controls. In the figure, the `TextBox` controls are bound to the columns of the `Product` table. Notice that the form also has a navigation bar. The navigation bar works just like the one that appears with a `DataGridView` control. It can be used to move forward and backward in the table, add new rows, delete the currently displayed row, and save the changes that have been made.

Notice in Figure 11-36 that each `TextBox` control has a `Label` control next to it, identifying the column. When you create a Details view, these `Label` controls are created automatically. As you can see in the figure, the underscores in the column name are replaced by spaces in the `Label` controls.



### Tutorial 11-3:

#### Creating the *Products* Application and Using a Details View

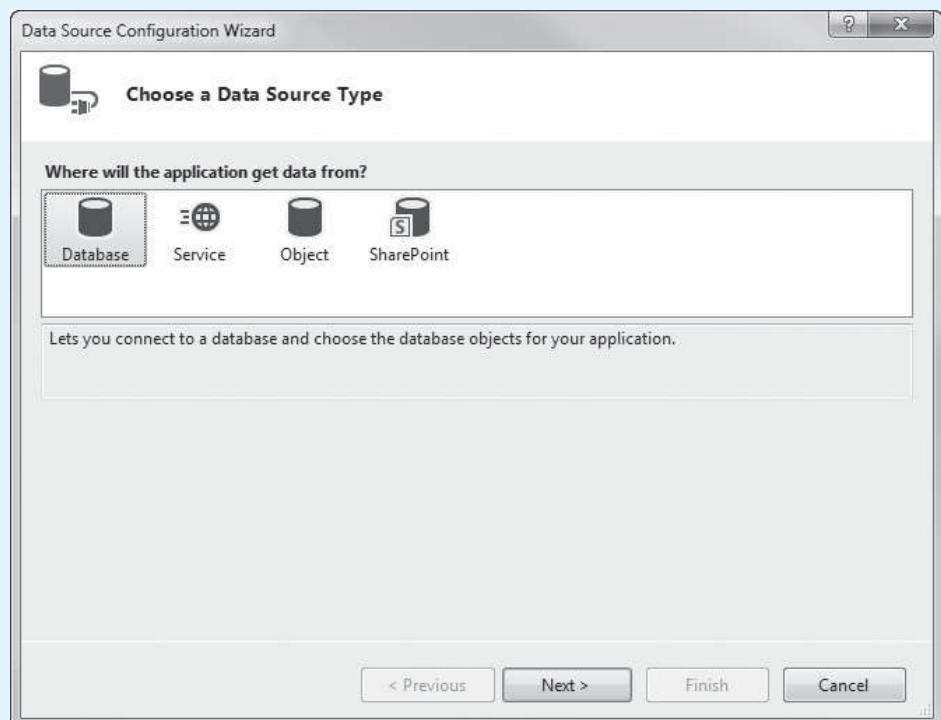


VideoNote

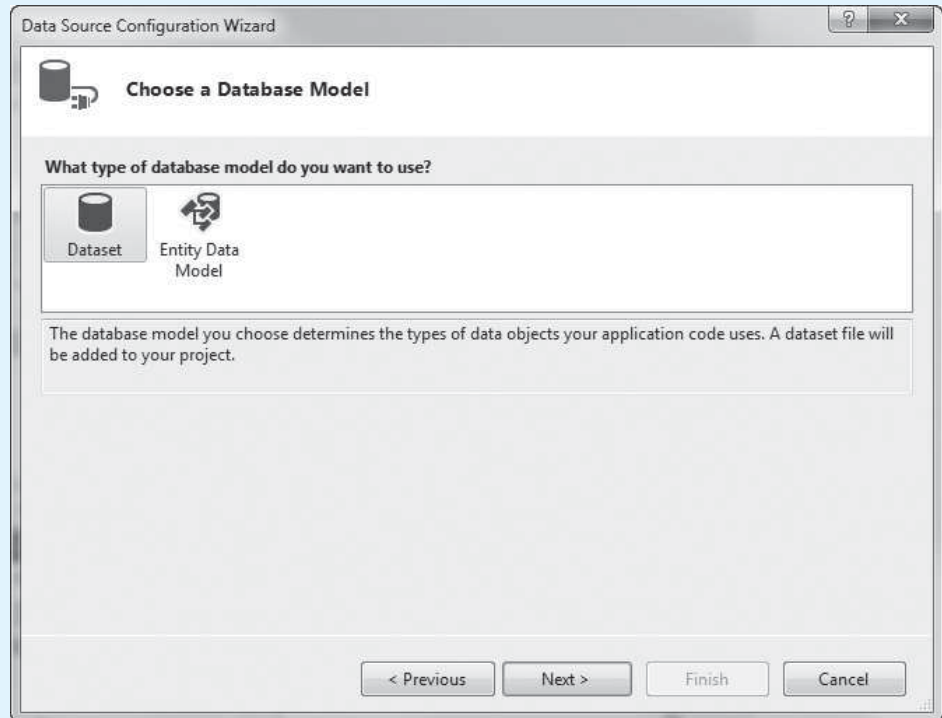
**Tutorial 11-3:**  
Creating the  
*Products*  
Application  
and Using a  
Details View

- Step 1:** Start Visual Studio (or Visual Studio Express). Create a new *Windows Forms Application* project named *Products*.
- Step 2:** Change the `Form1` form's `Text` property to *Products*.
- Step 3:** Click `PROJECT` on the Visual Studio menu bar and then click *Add New Data Source*. . . . You should see the *Data Source Configuration Wizard*, as shown in Figure 11-37. Make sure *Database* is selected and then click *Next >*.

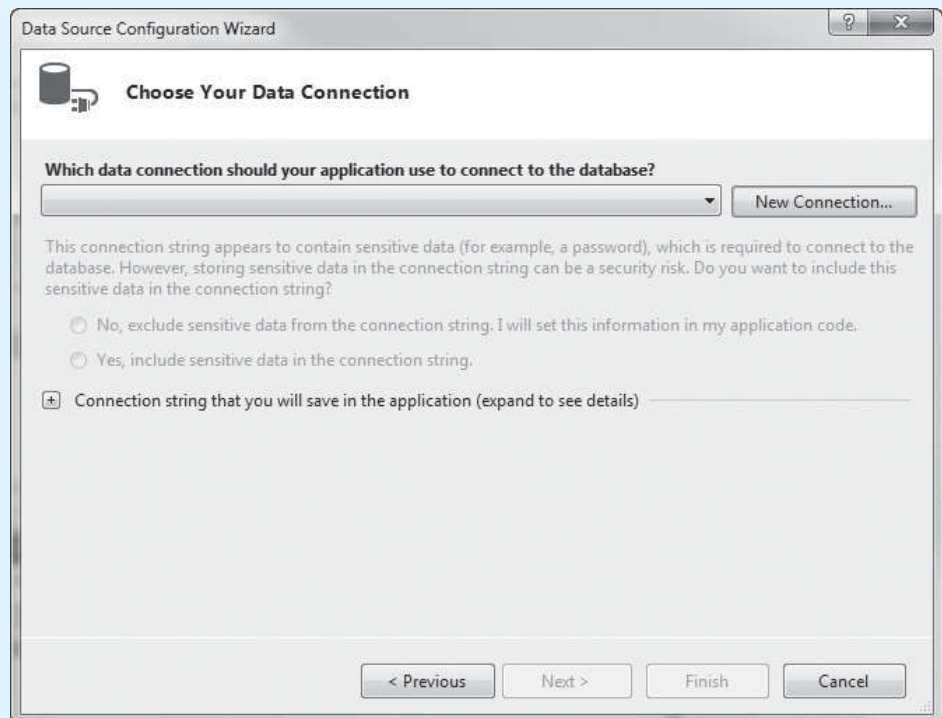
**Figure 11-37** The *Data Source Configuration Wizard*—Choose a Data Source Type



- Step 4:** The window now appears as shown in Figure 11-38. Make sure *Dataset* is selected, and click *Next >*.

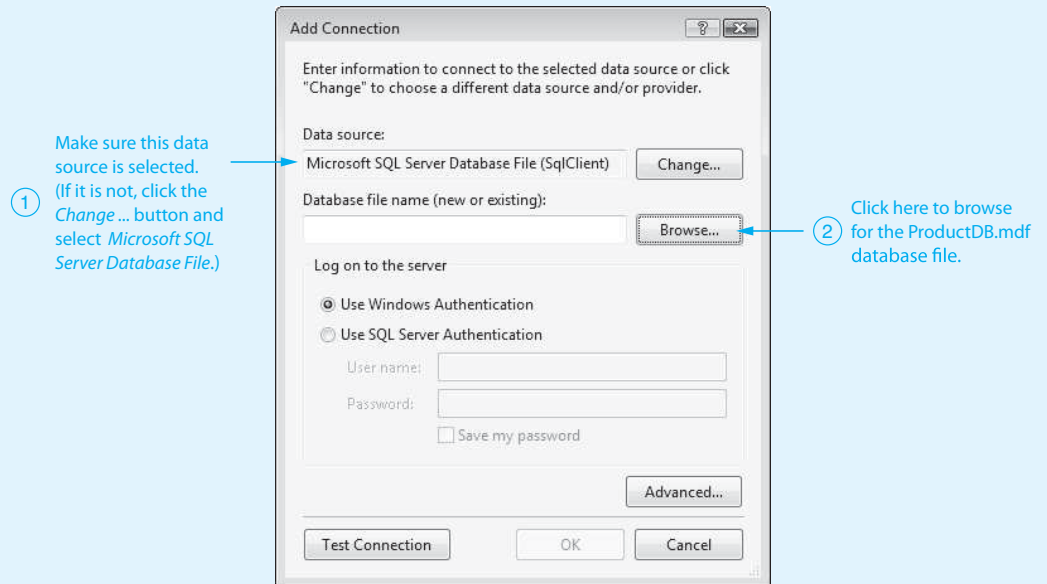
**Figure 11-38** The *Data Source Configuration Wizard—Choose a Database Model*

**Step 5:** The window now appears as shown in Figure 11-39. In this window you are asked to choose a data connection. Because you have not previously created any data connections in this project, none are available for you to choose from. So, you will have to create a new data connection. Click the *New Connection* button.

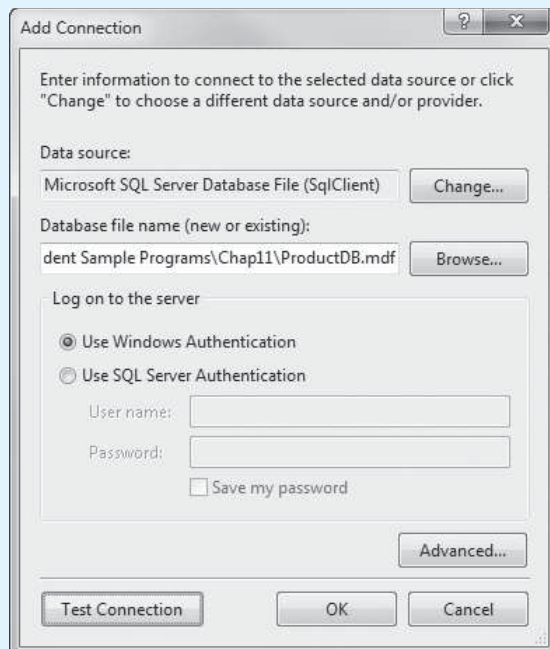
**Figure 11-39** The *Data Source Configuration Wizard—Choose Your Data Connection*

**Step 6:** You see the *Add Connection* dialog box next, as shown in Figure 11-40. (**Important:** The screens shown in Figures 11-40 and 11-41 were taken from Visual Studio. If you are using Visual Studio Express, the dialog box will look slightly different. The steps given here will work regardless of the version you are using.)

**Figure 11-40** The *Add Connection* dialog box (Visual Studio)



**Figure 11-41** The data source and database file selected (Visual Studio)



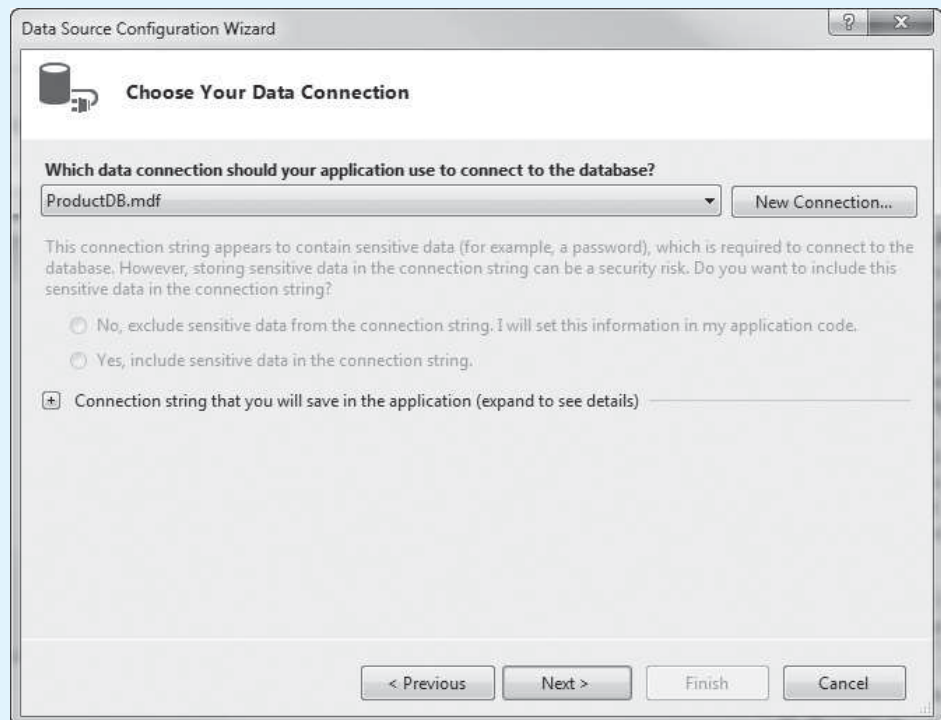
Perform the following:

- Look *carefully* at the selected data source. Make sure *Microsoft SQL Server Database File (SqlClient)* is selected. If not, click the *Change...* button and select *Microsoft SQL Server Database File*. (You will have to do this if you are using Visual Studio Express.)
- As indicated in the figure, click the *Browse. . .* button. Navigate to the *Chap11* folder in the Student Sample Programs and select the *ProductDB.mdf* file.

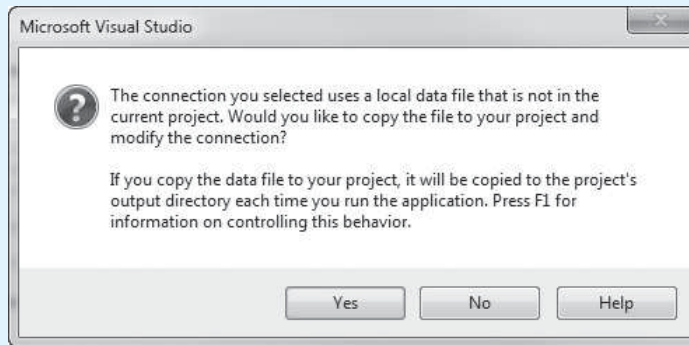
Figure 11-41 shows how the dialog box should appear now. At this point, you can optionally click the *Test Connection* button to test the connection to the database. You should see the message *Test Connection Succeeded*.

- Step 7:** Click the OK button on the *Add Connection* dialog box to close the dialog box.
- Step 8:** You should be back at the *Data Source Configuration Wizard*, as shown in Figure 11-42. As shown in the figure, *ProductDB.mdf* should be selected as the data connection. Click the *Next >* button to continue.

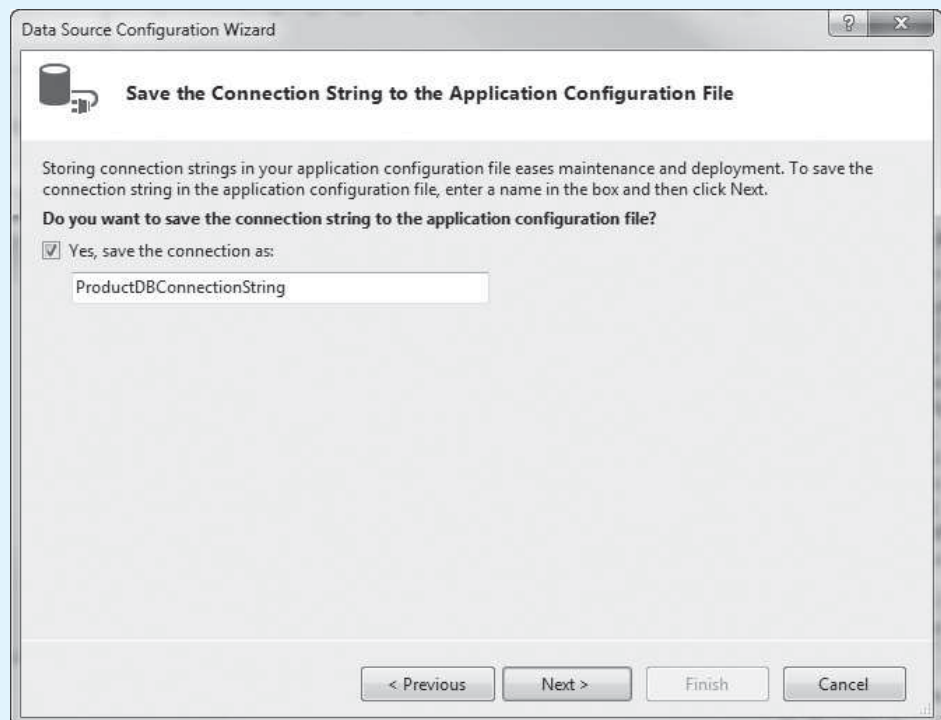
**Figure 11-42** The *Data Source Configuration Wizard* with *ProductDB.mdf* selected



- Step 9:** You should see the dialog box shown in Figure 11-43. The message is telling you that the database file is located outside the project folder, and you are being asked if you want to copy it into the project. Unless your instructor has told you to do otherwise, click *Yes*. That will make it easier for you to copy the complete project to submit to your instructor.

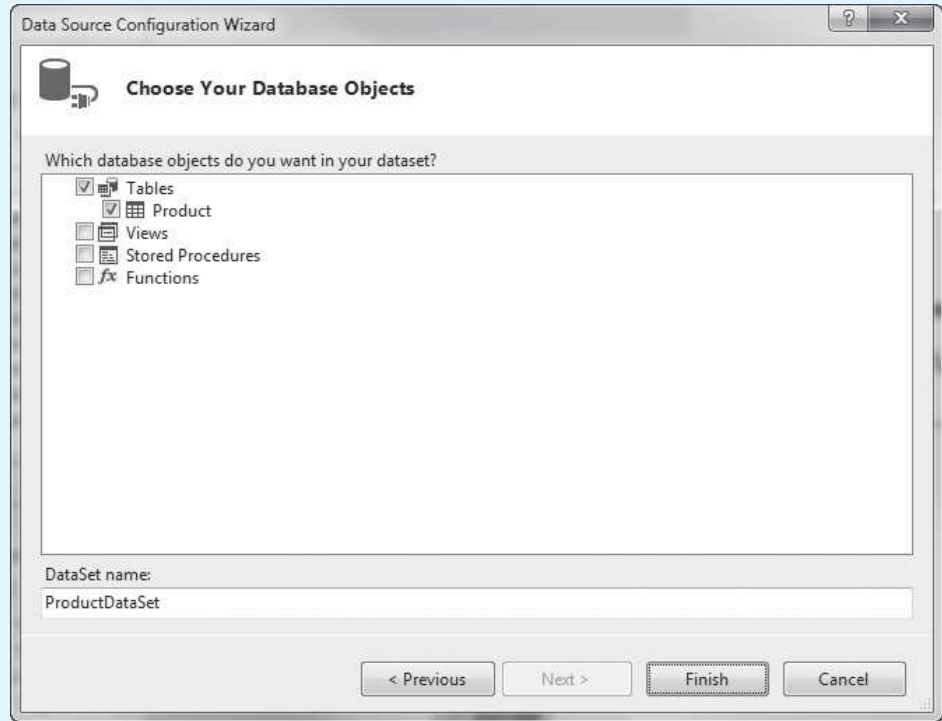
**Figure 11-43** Message about copying the database to the project

**Step 10:** The *Data Source Configuration Wizard* should now appear as shown in Figure 11-44. Click the *Next >* button to continue.

**Figure 11-44** The *Data Source Configuration Wizard*—*Save the Connection String*

**Step 11:** The *Data Source Configuration Wizard* should now appear, as shown in Figure 11-45. You are asked to choose the database objects that you want to include in the dataset. Expand the *Tables* entry and place a check next to `Product`, as shown in Figure 11-45.

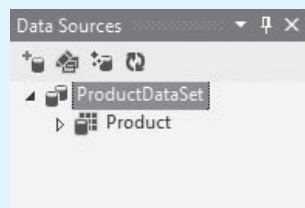
At the bottom of the window, you can specify a name for the dataset. The default name `ProductDBDataSet` is already provided. Because you selected the `Product` table as the database object, change the dataset name to `ProductDataSet`. Click *Finish*.

**Figure 11-45** The *Data Source Configuration Wizard—Choose Your Database Objects*

Here is a summary of what you just did:

- You added the ProductDB.mdf database as a data source to the application.
- You created a dataset component that is connected to the `Product` table. The name of the dataset component is `ProductDataSet`.

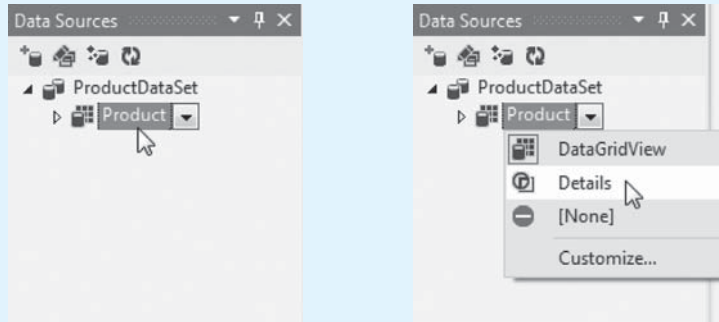
**Step 12:** Next you display the *Data Sources* window. Click *VIEW* on the Visual Studio menu bar, then select *Other Windows*, then click *Data Sources*. The *Data Sources* window should be displayed, as shown in Figure 11-46. Notice that the window shows the name of the dataset, which is `ProductDataSet`, and the name of the table that the dataset is connected to, which is `Product`.

**Figure 11-46** The *Data Sources* window

**Step 13:** Now you select *Details* as the default data-bound control for the `Product` table. In the *Data Sources* window, click the entry for the `Product` table, as shown

in the image on the left in Figure 11-47. Then, click the down arrow (▼), and select *Details*, as shown in the image on the right.

**Figure 11-47** Selecting *Details* as the data-bound control for the `Product` table

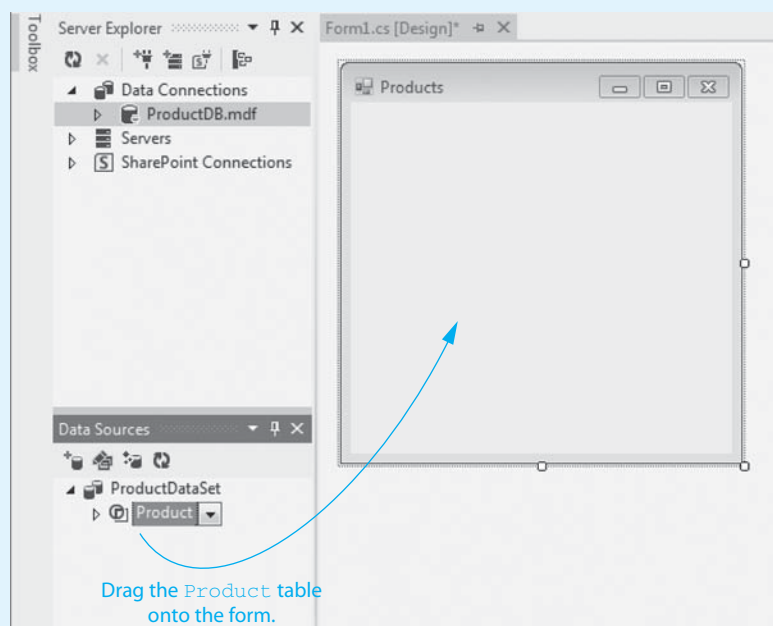


Select *Product*.

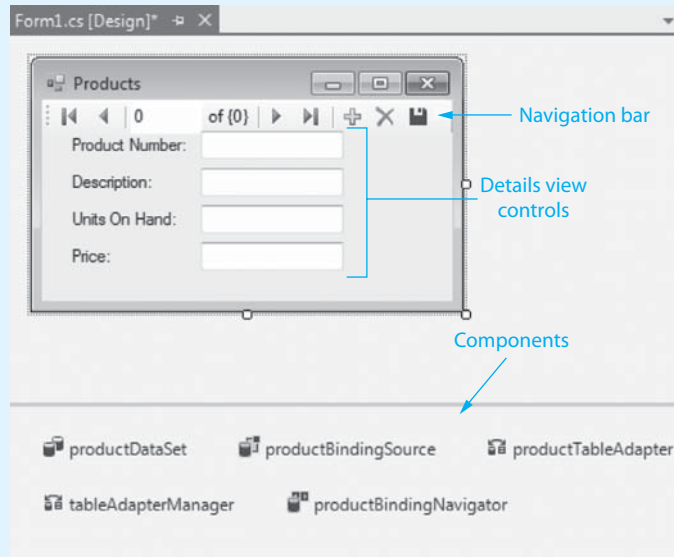
Click the down-arrow and select *Details*.

**Step 14:** Next you add a Details view onto the form. As shown in Figure 11-48, click and drag the `Product` table from the *Data Sources* window onto the form. As shown in Figure 11-49, this creates a set of Details view controls, complete with a navigation bar, on the form. (Adjust the size of the form and the size and position of the controls so they appear similar to Figure 11-49.)

**Figure 11-48** Dragging the `Product` table onto the form

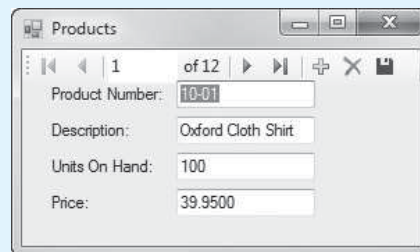




**Figure 11-49** Placing the Details view controls on the form

**Step 15:** Save and run the application. The form will appear similar to Figure 11-50, with data from the first row of the `Product` table displayed. You can use the form in the following ways:

- On the navigation bar, the *Move next* button ( $\blacktriangleright$ ) moves your view to the next row, and the *Move last* button ( $\blacktriangleright\blacktriangleright$ ) moves your view to the last row.
- The *Move previous* button ( $\blacktriangleleft$ ) moves your view to the previous row, and the *Move first* button ( $\blacktriangleleft\blacktriangleleft$ ) moves your view to the first row.
- The values of a row are displayed in text boxes. To change a value, simply click the text box with the mouse and then change its data as necessary.
- To add a new row, click the *Add* button ( $\oplus$ ). An empty row will be created and displayed. Enter data for the new row into the text boxes.
- To delete the row that is currently displayed, click the *Delete* button ( $\otimes$ ) on the navigation bar.
- The changes that you make affect only the in-memory copy of the table that is held in the dataset. To save the changes to the database, click the *Save* button ( $\text{floppy disk}$ ) on the navigation bar.

**Figure 11-50** The *Phone Book* application running

**Step 16:** Use the Details view controls to make several changes to the dataset. For example, change a value in an existing row, add a new row, and delete an existing row. Be sure to click the *Save* button ( $\text{floppy disk}$ ) on the navigation bar to save your changes. Close the application when you are finished.

## Copies of the Database at Run Time

Recall that in Step 9 of Tutorial 11-3, Visual Studio displayed a message indicating that you had selected a database file located outside the project folder, and you were asked if you wanted to copy the file into the project. (See Figure 11-43.) You answered *Yes*, and, as a result, the database file was copied into the project folder.

Then, when you ran the application for the first time, Visual Studio copied the database file from the project folder to the project's **output folder**, which is the *bin\Debug* folder. Each subsequent time the application runs, it connects to the copy of the database in the output folder instead of the project folder.

Suppose you make a change to the application, such as repositioning a control, and you run it again. Because you modified the application, Visual Studio rebuilds the project (recompiles it). Visual Studio also copies the database file, once again, from the project folder to the output folder. As a side effect, any changes that you previously made to the database will be lost!

You can get around this behavior by answering *No* to the dialog box shown in Figure 11-43. That causes the application to always connect to the database in its external location. However, if you are being graded on the project, your instructor will have trouble running it on his or her computer because the database file will be missing. So, it is normally a good idea to answer *Yes* to the dialog box in Figure 11-43, as long as you are aware that rebuilding the project causes the database in the output folder to be overwritten.



### Checkpoint

11.16 How can you create a form that shows the columns of only a single row of a database in an application?

11.17 What happens when you drag a table from the *Data Sources* window onto a form?

11.18 Where is a project's output folder located?

## 11.6

## More about Data-Bound Controls

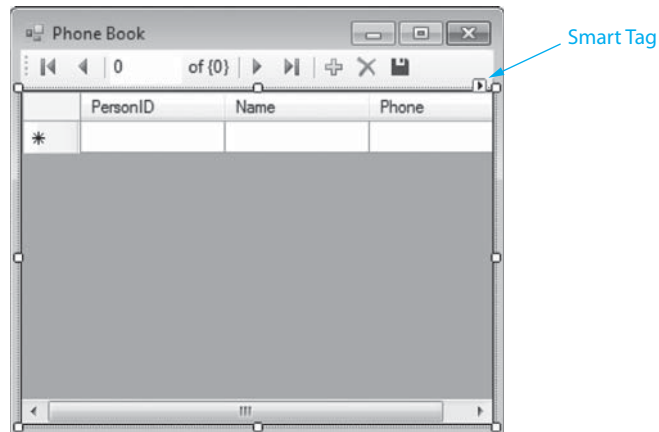
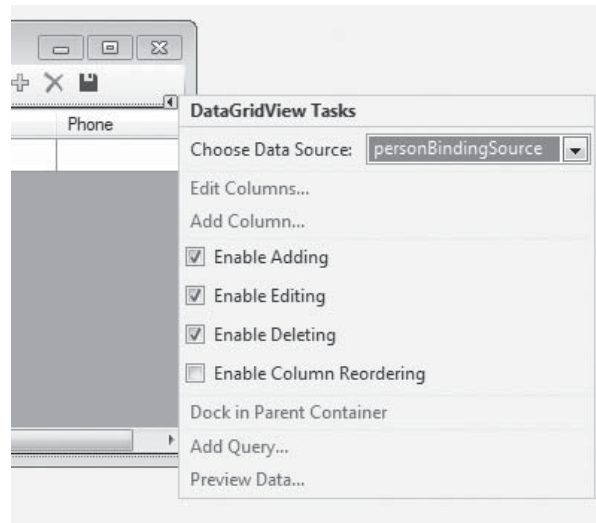
**CONCEPT:** The `DataGridView` control and the `Details` view may be customized in various ways. Other controls, such as list boxes, can be data-bound to allow interaction with a database.

### Customizing the `DataGridView` Control

In the *Designer*, if you select a `DataGridView` control, you will see a small arrow in the upper-right corner of the control's bounding box. Figure 11-51 shows an example. This is called a **smart tag**. When you click on the smart tag, a tasks panel will pop up, giving you a number of options that you can perform with the `DataGridView` control. Figure 11-52 shows an example of the tasks panel.

Notice in the figure that the tasks panel has the following check boxes:

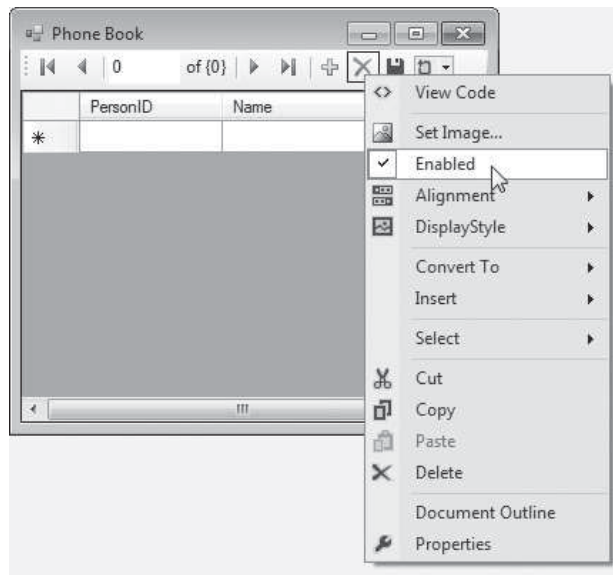
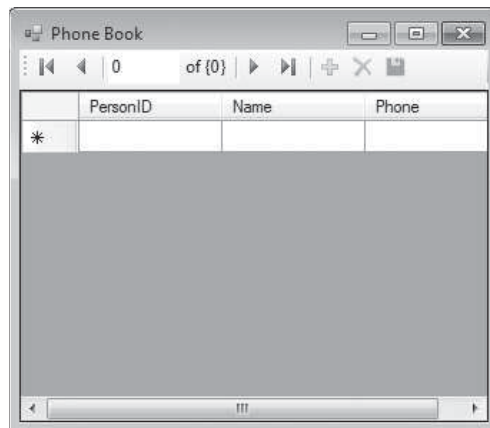
- *Enable Adding*—When this item is checked, the user may add rows in the `DataGridView` control. This item is checked by default.
- *Enable Editing*—When this item is checked, the user may change the contents of rows in the `DataGridView` control. This item is checked by default.

**Figure 11-51** A DataGridView control's smart tag**Figure 11-52** A DataGridView control's tasks panel

- *Enable Deleting*—When this item is checked, the user may delete rows from the DataGridView control. This item is checked by default.
- *Enable Column Reordering*—When this item is checked, the user may click and drag columns to rearrange them in the DataGridView control. This item is not checked by default.

If you do not want the user to be able to add, edit, or delete rows in the DataGridView control, simply remove the appropriate checkmarks.

Keep in mind that the navigation bar has buttons that allow the user to add, delete, and save the data in the DataGridView control. These buttons will still work, even after you have disabled adding, editing, and deleting in the DataGridView control's tasks panel. To disable a button on the navigation bar, right-click it in the *Designer*. This will display the pop-up menu shown in Figure 11-53. Notice in the figure that *Enabled* is checked. Click *Enabled* to remove the checkmark, thus disabling the button. When a button is disabled, it will appear grayed-out on the navigation bar. Figure 11-54 shows an example with the *Add*, *Delete*, and *Save* buttons disabled.

**Figure 11-53** Disabling the *Delete* button**Figure 11-54** The *Add*, *Delete*, and *Save* buttons disabled (grayed-out)

## Customizing the Details View

In Tutorial 11-3 you saw how several controls are created automatically when you create Details view for a table. For example, TextBoxes were created and bound to the individual columns. Label controls that identify the columns were also created, as was a navigation bar.

When you create a Details view, the type of control that a column is automatically bound to is determined by the column's data type, as follows:

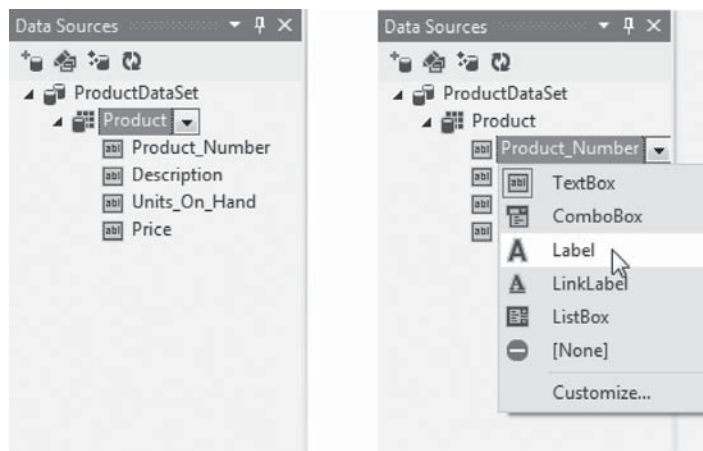
- Columns containing character data are bound to TextBox controls by default.
- Numeric columns are bound to TextBox controls by default.
- Bit columns are bound to CheckBox controls.
- Datetime columns are bound to DateTimePicker controls, which allow the user to select a date from a small pop-up calendar.

It is possible to change the type of control that a column is bound to in a Details view. For example, recall that the `Product` table in Tutorial 11-3 has a column named

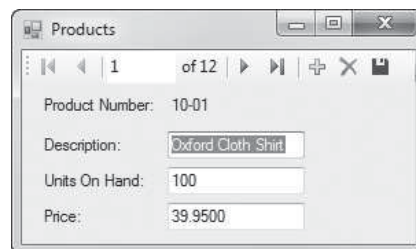
`Product_Number`. The `Product_Number` column contains character data, so a `TextBox` control was created for it when you placed the `Details` view on the form. However, the `Product_Number` column is the primary key for the table, so you might not want the user to be able to change it. A `Label` control might be a better option. That way, the user can see the product number but cannot change it.

Before you place a `Details` view on a form, you can select the type of control to which each column will be bound. In the *Data Sources* window, expand the table entry as shown in the image on the left in Figure 11-55. Then, select a column and click the down arrow (▼) that appears next to it, as shown in the image on the right in the figure. A menu will pop up that shows the types of controls that you can select. In the image on the right in Figure 11-55, we are selecting the `Label` control for the `Product_Number` column. Then, when we create the `Details` view, it appears as shown in Figure 11-56.

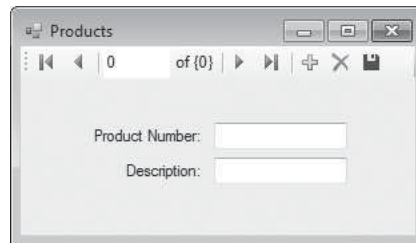
**Figure 11-55** Selecting the type of data-bound control for a column



**Figure 11-56** Details view with the product number displayed in a `Label` control



When you drag an entire table from the *Data Sources* window and drop it onto a form, the `Details` view that is created contains data-bound controls for all the columns. Sometimes you might not want all the columns displayed, however. Alternatively, you can drag the individual columns, one at a time, from the *Data Sources* window onto the form. Figure 11-57 shows an example of a `Details` view that displays only the product number and description. We created this `Details` view by dragging the `Product_Number` column and then the `Description` column from the *Data Sources* window onto the form.

**Figure 11-57** Product number and description displayed

## Binding Columns to ListBox Controls

A list box can be a convenient way to look up data in a table. You can bind a column to a ListBox control, which causes all the values in that column to be displayed in the list box. When the user selects an item from the list box, the rest of the columns from the selected row can be displayed.

To bind a ListBox control to a column, you must set two of the control's properties: **DataSource** and **DisplayMember**. The **DataSource** property identifies the table from which the ListBox will get its data. The **DisplayMember** property identifies the column. In Tutorial 11-4 you use this technique to create a data lookup form for the ProductDB.mdf database.



VideoNote

**Tutorial 11-4:**  
Creating  
the *Product  
Lookup*  
Application

### Tutorial 11-4:

#### Creating the *Product Lookup* Application

- Step 1:** Start Visual Studio (or Visual Studio Express). Create a new *Windows Forms Application* project named *Product Lookup*.
- Step 2:** Change the Form1 form's Text property to *Product Lookup*.
- Step 3:** Perform the following steps to connect the application to the ProductDB.mdf database, and select the `Product` table as the dataset:
- From the *PROJECT* menu, select *Add New Data Source...*
  - Select *Database* and click *Next >*.
  - Select *Dataset* and click *Next >*.
  - Click *New Connection...*
  - In the *Add Connection* window, make sure *Microsoft SQL Server Database File (SqlClient)* is the selected data source.
  - In the *Add Connection* window, click *Browse*, and go to the *Chap11* folder in the Student Sample Programs. Select the *ProductDB.mdf* file. Click *OK*.
  - Click *Next >*, and when asked if you want to copy the file to the project, click *Yes*.
  - Click *Next >*.
  - Select the `Product` table as the database object, and change the name of the dataset to `ProductDataSet`. Click *Finish*.

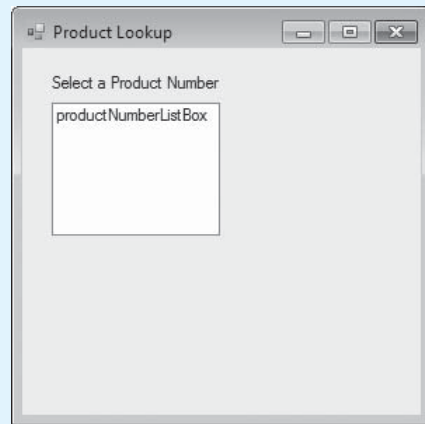


**NOTE:** This is the same procedure that you performed in Steps 3–11 in Tutorial 11-3. If you want more detailed guidance, go back to that tutorial to see the actual screens.

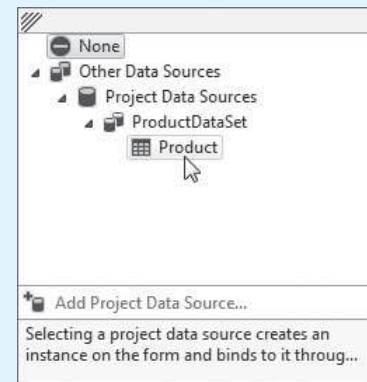
**Step 4:** Create a `ListBox` control named `productNumberListBox`. Just above the `ListBox`, place a `Label` control that displays “Select a Product Number”. The form should look similar to Figure 11-58.

**Step 5:** Select the `ListBox` control. In the *Properties* window, select the `DataSource` property and then click the down arrow (▼) that appears next to it. In the list that pops up, expand *Other Data Sources*, then expand *Project Data Sources*, then expand *ProductDataSet*, and then select *Product*. This is shown in Figure 11-59.

**Figure 11-58** `ListBox` and `Label` created



**Figure 11-59** `Product` table selected in the `DataSource` property

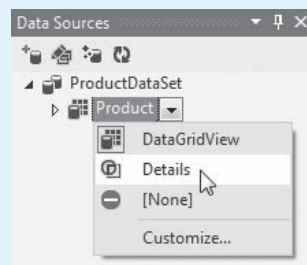


**Step 6:** Select the `ListBox` control’s `DataMember` property and then click the down arrow (▼) that appears next to it. In the list that pops up, select `Product_Number`.

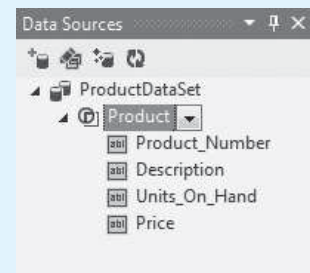
**Step 7:** In the *Data Sources* window, set the `Product` table’s view to *Details*, as shown in Figure 11-60.

**Step 8:** In the *Data Sources* window, expand the `Product` table so the column names are displayed, as shown in Figure 11-61.

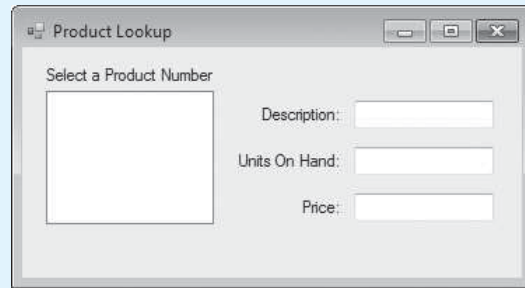
**Figure 11-60** Select *Details*



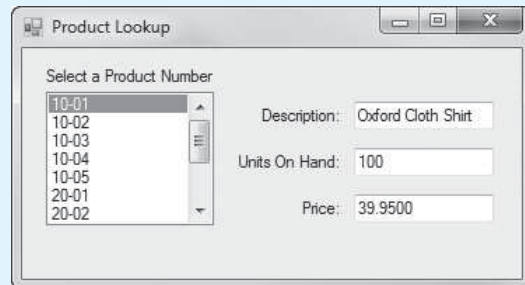
**Figure 11-61** Column names displayed



**Step 9:** One at a time, drag the `Description`, `Units_On_Hand`, and `Price` columns from the *Data Sources* window onto the form. Place them as shown in Figure 11-62. Resize the form so it appears similar to that shown in the figure.

**Figure 11-62** Column names displayed

**Step 10:** Save the project and run the application. The application's form should appear similar to Figure 11-63. Notice that the list box contains a list of all the product numbers in the `Product` table. When you select a product number in the list box, that product's description, units on hand, and price are displayed in the `TextBox` controls. When you are finished, exit the application.

**Figure 11-63** The *Product Lookup* application running

## Having Data-Bound Controls on Multiple Forms

You have seen that when you place a data-bound control on a form, Visual Studio automatically creates a set of components that allow the form to connect to the database. These components include a dataset. When you place data-bound controls on multiple forms, keep in mind that each form has its own dataset. When you make changes to the dataset in one form, those changes do not automatically appear in other forms that have their own dataset. Consider the following scenario:

- Form1 displays a view of a database, perhaps in a `DataGridView` control.
- Some code in Form1 displays Form2.
- Form2 also displays a view of the same database, allowing the user to make changes and save those changes to the database. The user closes Form2.
- Form1 is still displaying its original copy of the data. Its dataset does not automatically update, so Form1 does not show the changes that were made by Form2.

To make sure that a dataset contains a current copy of the data, you need to write code that causes the table adapter to read the database table and fill the dataset. You do this by calling the table adapter's `Fill` method. In Tutorial 11-5 you learn how to do this by creating an application that correctly handles the scenario previously discussed.





VideoNote

**Tutorial 11-5:**  
Creating the  
*Multiform  
Products*  
Application



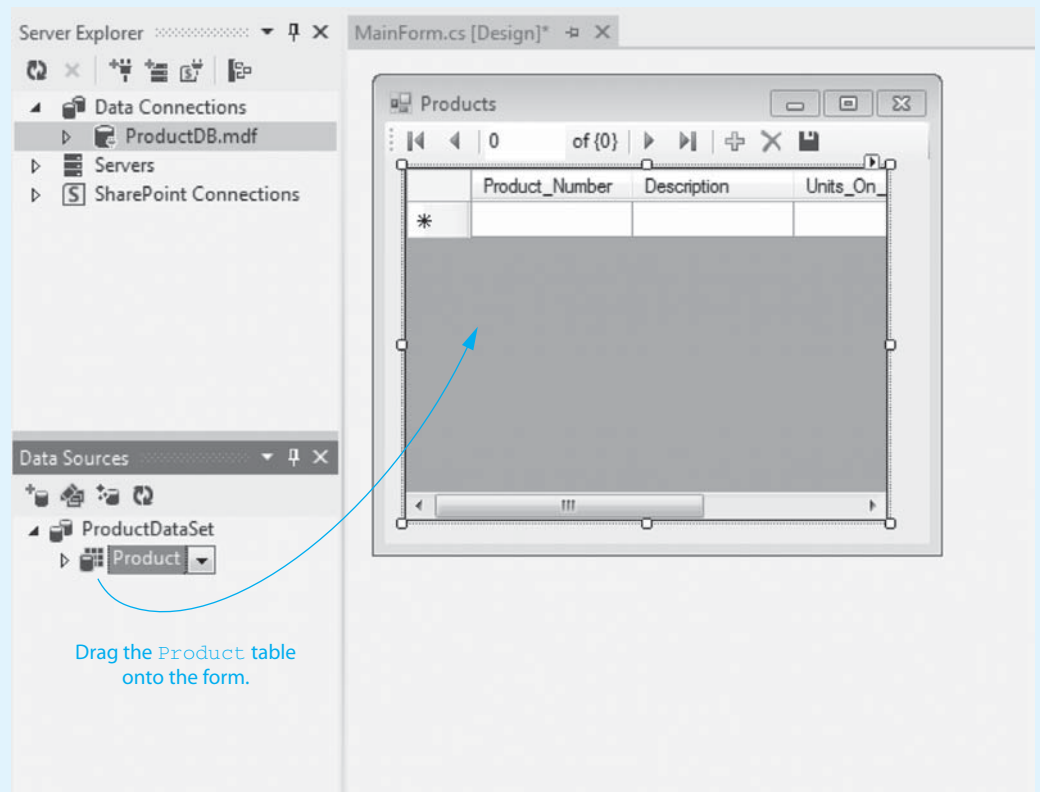
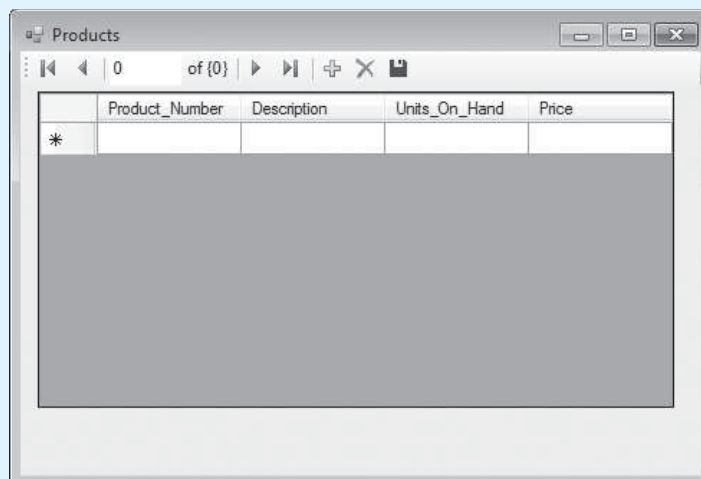
## Tutorial 11-5: Creating the *Multiform Products* Application

- Step 1:** Start Visual Studio (or Visual Studio Express). Create a new *Windows Forms Application* project named *Multiform Products*.
- Step 2:** Change the Form1 form's Text property to *Products*.
- Step 3:** In the *Solution Explorer*, change the name of Form1.cs to *MainForm.cs*. This changes the name of the Form1 form to MainForm.
- Step 4:** Perform the following steps to connect the application to the ProductDB.mdf database and select the `Product` table for the dataset:
- From the *PROJECT* menu, select *Add New Data Source. . . .*
  - Select *Database* and click *Next >*.
  - Select *Dataset* and click *Next >*.
  - Click *New Connection. . . .*
  - In the *Add Connection* window, make sure *Microsoft SQL Server Database File (SqlClient)* is the selected data source.
  - In the *Add Connection* window, click *Browse* and go to the *Chap11* folder in the Student Sample Programs. Select the *ProductDB.mdf* file. Click *OK*.
  - Click *Next >*, and when asked if you want to copy the file to the project, click *Yes*.
  - Click *Next >*.
  - Select the `Product` table as the database object, and change the name of the dataset to `ProductDataSet`. Click *Finish*.



**NOTE:** This is the same procedure that you performed in Steps 3–11 in Tutorial 11-3. If you want more detailed guidance, go back to that tutorial to see the actual screens.

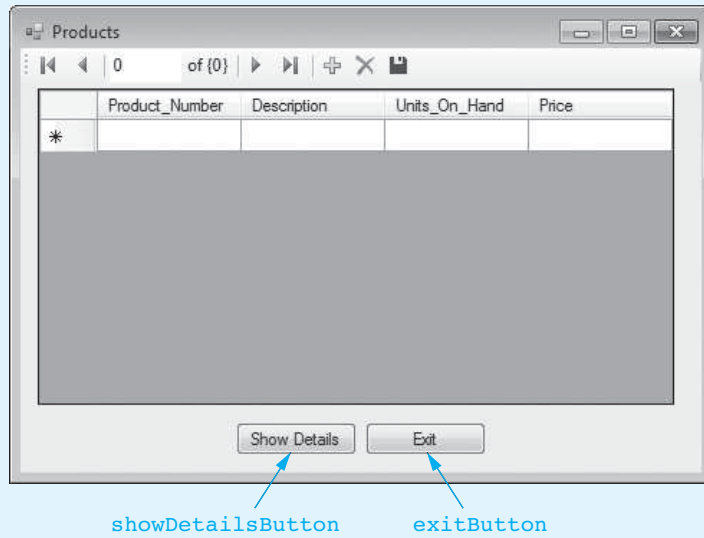
- Step 5:** Open the *Data Sources* window and, as shown in Figure 11-64, drag a *DataGridView* control onto the form, bound to the `Product` table. After creating the *DataGridView* control, adjust size of the form and the control as shown in Figure 11-65.
- Step 6:** Create the *Button* controls shown in Figure 11-66. (You write *Click* event handlers for these buttons later.)
- Step 7:** Add another form named *DetailsForm* to the project. As a reminder, these are the steps:
- Click *PROJECT* on the Visual Studio menu bar and then select *Add Windows Form. . . .*
  - In the *Add New Item* window, enter *DetailsForm.cs* as the name and click *Add*.
- Step 8:** Change the form's Text property to *Details*.
- Step 9:** In the *Data Sources* window, change the `Product` table's default view to *Details*, as shown in Figure 11-67. Then, as shown in Figure 11-68, drag a *Details* view onto the form.

**Figure 11-64** Create a DataGridView control on the form**Figure 11-65** The form and DataGridView control resized

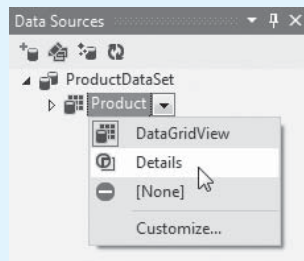
**Step 10:** Resize the DetailsForm form and create the Button control shown in Figure 11-69.

**Step 11:** Double-click the closeButton control, and complete its Click event handler, as shown in lines 37–38 of Program 11-2.

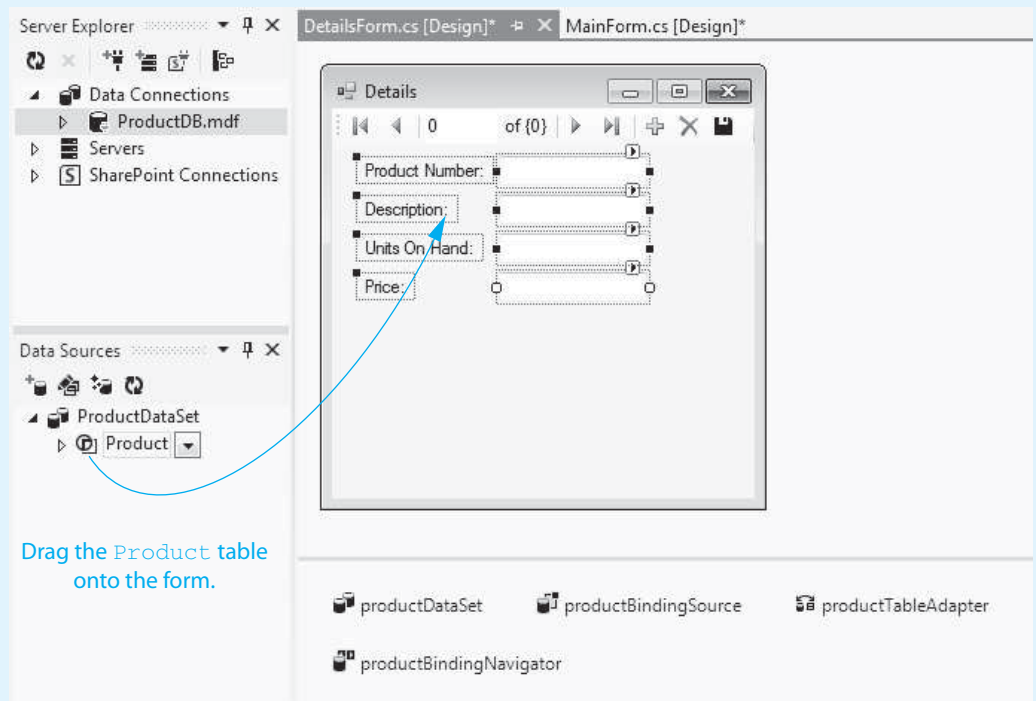
**Figure 11-66** Button controls placed on the MainForm

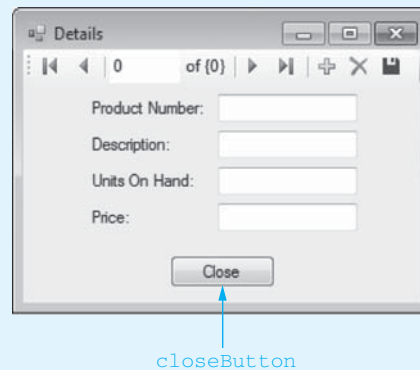


**Figure 11-67** Changing the Product table's default view to Details



**Figure 11-68** Creating a Details view on the form



**Figure 11-69** Form resized and *Close* button placed

**Step 12:** Switch your view back to the MainForm form in the *Designer*. Double-click the `showDetailsButton` control, and complete its Click event handler, as shown in lines 37–44 of Program 11-3. Let’s take a closer look at the code:

**Line 38:** This statement creates an instance of the `DetailsForm` class, referred to by the `details` variable.

**Line 41:** This statement displays the `DetailsForm` form. The user will be able to make changes to the product data using the `DetailsForm` and save those changes to the database.

**Line 44:** This statement calls the table adapter’s `Fill` method, passing the dataset as an argument. As a result, the dataset will be filled with the current contents of the `Product` table, and the `DataGridView` control’s contents will be updated.

**Step 13:** Switch your view back to the MainForm form in the *Designer*. Double-click the `exitButton` control, and complete its Click event handler, as shown lines 49 and 50 of Program 11-3.

**Step 14:** Save the project and run the application. The MainForm should show the `Product` table in the `DataGridView` control. Click the *Show Details* button to display the `DetailsForm`.

In the `DetailsForm`, make some changes to the data. For example, change the value of an existing piece of data, insert a new row, or delete an existing row. After making the changes, be sure to click the *Save* button on the navigation bar. Then, click the *Close* button (✕) to close the `DetailsForm`.

Back at the MainForm, browse the data in the `DataGridView` control to confirm that it shows the changes you just made. When you are finished, exit the application.

### Program 11-2 Completed code for the `DetailsForm`

```

1 using System;
2 using System.Collections.Generic;
3 using System.ComponentModel;
4 using System.Data;
5 using System.Drawing;
6 using System.Linq;
7 using System.Text;
8 using System.Threading.Tasks;
9 using System.Windows.Forms;

```

```

10
11 namespace Multiform_Products
12 {
13     public partial class DetailsForm : Form
14     {
15         public DetailsForm()
16         {
17             InitializeComponent();
18         }
19
20         private void productBindingNavigatorSaveItem_Click(object sender, EventArgs e)
21         {
22             this.Validate();
23             this.productBindingSource.EndEdit();
24             this.tableAdapterManager.UpdateAll(this.productDataSet);
25
26         }
27
28         private void DetailsForm_Load(object sender, EventArgs e)
29         {
30             // TODO: This line of code loads data into the ...
31             this.productTableAdapter.Fill(this.productDataSet.Product);
32
33         }
34
35         private void closeButton_Click(object sender, EventArgs e)
36         {
37             // Close the form.
38             this.Close();
39         }
40     }
41 }

```

---

### Program 11-3 Completed code for the MainForm form

```

1 using System;
2 using System.Collections.Generic;
3 using System.ComponentModel;
4 using System.Data;
5 using System.Drawing;
6 using System.Linq;
7 using System.Text;
8 using System.Threading.Tasks;
9 using System.Windows.Forms;
10
11 namespace Multiform_Products
12 {
13     public partial class MainForm : Form
14     {
15         public MainForm()
16         {
17             InitializeComponent();
18         }
19
20         private void productBindingNavigatorSaveItem_Click(object sender, EventArgs e)
21         {
22             this.Validate();
23             this.productBindingSource.EndEdit();

```

```
24         this.tableAdapterManager.UpdateAll(this.productDataSet);
25     }
26 }
27
28 private void MainForm_Load(object sender, EventArgs e)
29 {
30     // TODO: This line of code loads data into the ...
31     this.productTableAdapter.Fill(this.productDataSet.Product);
32 }
33 }
34
35 private void showDetailsButton_Click(object sender, EventArgs e)
36 {
37     // Create an instance of the DetailsForm.
38     DetailsForm details = new DetailsForm();
39
40     // Display the form.
41     details.ShowDialog();
42
43     // Update the dataset.
44     this.productTableAdapter.Fill(this.productDataSet.Product);
45 }
46
47 private void exitButton_Click(object sender, EventArgs e)
48 {
49     // Close the form.
50     this.Close();
51 }
52 }
53 }
```



### Checkpoint

- 11.19 What happens when a control's smart tag is clicked in the *Designer*?
- 11.20 When you create a Details view, what determines the type of control to which a column is bound?
- 11.21 Which two properties must be set to bind a `ListBox` control to a column?
- 11.22 What is the name of the table adapter method that populates the dataset with a current copy of the data?

## 11.7

## Selecting Data with the SQL `Select` Statement

**CONCEPT:** SQL is a standard language that most DBMS support. The `Select` statement is used in SQL to retrieve data from a database.

SQL, which stands for **structured query language**, is a standard language for working with database management systems. It was originally developed by IBM in the 1970s. Since then, SQL has been adopted by almost all database software vendors as the language of choice for interacting with their DBMS.

SQL consists of several keywords. You use the keywords to construct statements, which are also known as **queries**. These statements, or queries, are submitted to the DBMS and are instructions directing the DBMS to carry out operations on its data. In this section you learn how to construct simple SQL statements and then pass them to the SQL Server DBMS.



**NOTE:** Although SQL is a language, you do not use it to write applications. It is intended only as a standard means of interacting with a DBMS. You still need a general programming language, such as C#, to write an application for the ordinary user.

In SQL you use the **Select statement** to retrieve the rows in a table. As its name implies, the `Select` statement allows you to select specific rows. We start with a very simple form of the statement, as shown here:

```
Select Columns From Table
```

In the general form, *Columns* is one or more column names, and *Table* is a table name. Here is an example `Select` statement that we might execute on the ProductDB.mdf database:

```
Select Description From Product
```

This statement retrieves the `Description` column for every row in the `Product` table. You can specify more than one column in a `Select` statement by separating the column names with commas. Here is an example:

```
Select Description, Price From Product
```

This statement retrieves the `Description` column and the `Price` column for every row in the `Product` table. If you wish to retrieve every column in a table, you can use the `*` character instead of listing column names. Here is an example:

```
Select * From Product
```

This statement retrieves every column for every row in the `Product` table. SQL statements are free form, which means that tabs, newlines, and spaces between the keywords are ignored. For example, the statement

```
Select * From Product
```

works the same as

```
Select
  *
From
  Product
```

In addition, SQL keywords and table names are case insensitive. The previous statement could be written as

```
SELECT * FROM PRODUCT
```

## Specifying a Search Criteria with the `Where` Clause

Sometimes you want to retrieve every row in a table. In many situations, however, you want to narrow the list down to only a few selected rows in the table. That is where the `where` clause comes in. The `where` clause can be used with the `Select` statement to specify the search criteria. When you use the `where` clause, only the rows that meet the search criteria are returned. The general format of a `Select` statement with a `where` clause is

```
Select Columns From Table Where Criteria
```

In the general format, *Criteria* is a conditional expression. Here is an example of a `Select` statement that uses the `Where` clause:

```
Select * From Product Where Price > 20.00
```

The first part of the statement, `Select * From Product`, specifies that we want to see every column. The `Where` clause specifies that we want only the rows in which the contents of the `Price` column are greater than 20.00. As a result, the `Select` statement retrieves only the rows in which `Price` is greater than 20.00.

SQL supports the relational operators listed in Table 11-2 for writing conditional expressions in a `Where` clause.

**Table 11-2** SQL relational operators

Operator	Meaning
>	Greater than
<	Less than
>=	Greater than or equal to
<=	Less than or equal to
=	Equal to
<>	Not equal to

Notice that the equal to and not equal to operators in SQL are different from those in C#. The equal to operator is one equal sign, not two equal signs. The not equal to operator is `<>`.

Let's look at a few more examples of the `Select` statement. The following statement could be used to retrieve the product numbers and prices of all the items that are priced at \$28.95:

```
Select Product_Number, Price From Product Where Price = 28.95
```

The following `Select` statement retrieves all the columns from only the rows where the description is "Denim Jeans".

```
Select * From Product Where Description = 'Denim Jeans'
```

If you look carefully at the previous statement, you will notice another difference between SQL syntax and C# syntax. In SQL, string literals are enclosed in single quotes, not double quotes.



**TIP:** If you need to include a single quote as part of a string, simply write two single quotes in its place. For example, suppose you wanted to search the `Product` table for Katy's Wool Cap. You could use the following statement:

```
Select * From Product Where Description = 'Katy''s Wool Cap'
```

String comparisons in SQL are case sensitive. If you ran the following statement against the `Product` table, you would not get any results:

```
Select * From Product Where Description = 'denim jeans'
```

However, you can use the `Lower()` function to convert a string to lowercase. Here is an example:

```
Select * From Product Where Lower(Description) = 'denim jeans'
```



This statement converts the `Description` column to all lowercase before performing the comparison. As a result, it will return all rows where `Description` equals “denim jeans” regardless of case. You could use the `Upper` function, which converts a string to uppercase, to achieve the same results:

```
Select * From Product Where Upper(Description) = 'DENIM JEANS'
```

## Using the Like Operator

Sometimes searching for an exact string will not yield the results you want. For example, suppose the `Product` table contains the rows shown in Figure 11-70 and we want a list of all the shirts.

The following statement will not work. Can you see why?

```
Select * From Product Where Description = 'Shirt'
```

**Figure 11-70** The `Product` table in the `ProductDB.mdf` database

Product_Number	Description	Units_On_Hand	Price
10-01	Oxford Cloth Shirt	100	39.9500
10-02	Poplin Shirt	150	38.5000
10-03	Plaid Flannel Shirt	80	34.7500
10-04	Canvas Shirt	200	32.9500
10-05	Cotton Shirt	250	28.9500
20-01	Chino Classic Fit Pants	100	28.9500
20-02	Chino Relaxed Fit Pants	100	28.9500
20-03	Denim Jeans	275	32.9500
20-04	Wool Trousers	75	78.9500
30-01	Warm-Up Jacket	125	59.9500
30-02	Fleece Pullover	150	28.9500
30-03	Parka	75	199.9500

This statement will search for rows where the `Description` column is equal to the string “`Shirt`”. Unfortunately, it will find none because there are no rows in which the `Description` column is equal to “`Shirt`”. However, the word “`Shirt`” does appear in the `Description` column of some of the rows. For example, in Figure 11-70 the first row’s `Description` column is “`Oxford Cloth Shirt`”, the second row’s `Description` column is “`Poplin Shirt`”, and so forth.

In order to find all the shirts, we need to search for rows where “`Shirt`” appears as a substring in the `Description` column. You can perform just such a search using the `Like` operator. Here is an example of how to use it.

```
Select * From Product Where Description Like '%Shirt%'
```

The `Like` operator is followed by a string that contains a character pattern. In this example, the character pattern is `'%Shirt%'`. The `%` symbol is used as wildcard character. It represents any sequence of zero or more characters. The pattern `'%Shirt%'` specifies that the string “`Shirt`” must appear with any sequence of characters before or after it. So, the statement previously shown would return all rows in which the `Description` column contains the string “`Shirt`”.

Likewise, the following statement will result in all the rows where the `Description` column starts with the word “`Chino`”.

```
Select * From Product Where Description Like 'Chino%'
```

The underscore character ( `_` ) is also used as a wildcard. Unlike the `%` character, the underscore represents a single character. For example, look at the following statement:

```
Select * From Product Where Product_Number Like '2_0_'
```

This statement will result in all the rows where the `Product_Number` column begins with "2", followed by any one character, followed by "0", followed by any one character.

You can use the `Not` operator to disqualify a character pattern in a search criteria. For example, suppose you want a list of all the items that are not shirts. The following statement will yield just those results.

```
Select * From Product Where Description Not Like '%Shirt%'
```

## Using `And` and `Or`

You can use the `And` and `Or` logical operators to specify multiple search criteria in a `Where` clause. For example, look at the following statement:

```
Select * From Product Where Price > 20.00 And Price < 30.00
```

The `And` operator requires that both search criteria be true in order for a row to be qualified as a match. The only rows that will be returned from this statement are those where the `Price` column contains a value that is greater than 20.00 and less than 30.00.

Here's an example that uses the `Or` operator:

```
Select * From Product  
Where Description Like '%Shirt%' or Product_Number Like '10-%'
```

The `Or` operator requires that either of the search criteria be true in order for a row to be qualified as a match. This statement searches for rows where the `Description` column contains the string "Shirt" at any position or where the `Product_Number` column starts with "10-".

## Sorting the Results of a `Select` Query

If you wish to sort the results of a `Select` query, you can use the `Order By` clause. Here is an example:

```
Select * From Product Order By Price
```

This statement produces a list of all the rows in the `Product` table, ordered by the `Price` column. The list will be sorted in ascending order on the `Price` column, meaning that the lowest-priced coffees will appear first.

Here's a `Select` query that uses both a `Where` clause and an `Order By` clause:

```
Select * From Product  
Where Price > 20.00  
Order By Price
```

This statement produces a list of all the rows in the `Product` table where the `Price` column contains a value greater than 20.00, listed in ascending order by price.

If you want the list sorted in descending order (from highest to lowest), use the `Desc` operator, as shown here:

```
Select * From Product  
Where Price > 20.00  
Order By Price Desc
```

## Table Adapter Queries

A **table adapter query** is an SQL statement that is stored in a table adapter and can be executed simply by calling a method. For example, all table adapters contain a query that fills a dataset with data from a table. That query can be executed by calling the table adapter's `Fill` method. When you place a data-bound control, such as a `DataGridView` control, on a form, a Load event handler that calls the table adapter's `Fill` method is automatically created for the form.

Let's look at an example. In Visual Studio, open the *Multiform Products* project that you created in Tutorial 11-5, and open source code for the `MainForm` form. Look at the form's Load event handler, which is shown here (the comment that appears in line 3 has been shortened to fit on the page):

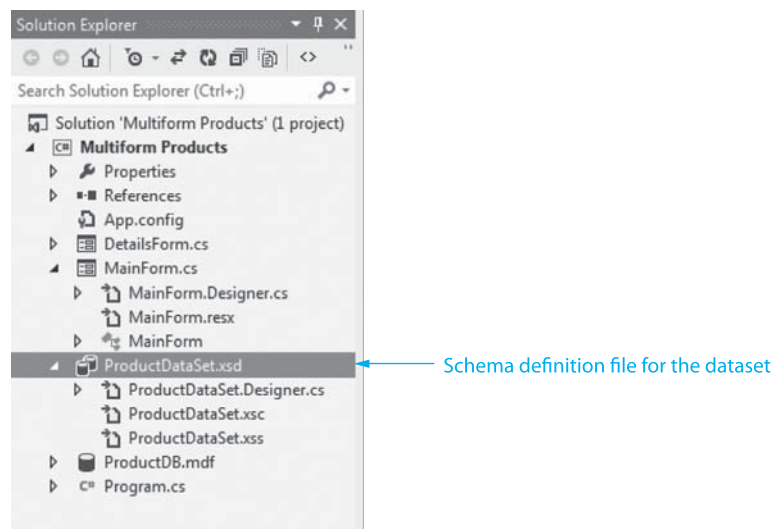
```

1 private void MainForm_Load(object sender, EventArgs e)
2 {
3     // TODO: This line of code loads data into ...
4     this.productTableAdapter.Fill(this.productDataSet.Product);
5
6 }

```

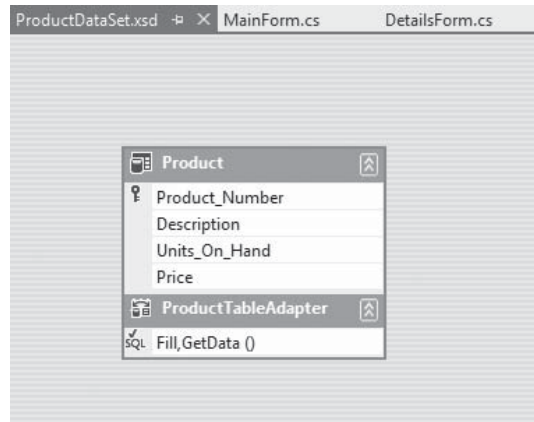
The statement in line 4 calls the `productTableAdapter`'s `Fill` method, passing the dataset's `Product` table as an argument. The `Fill` method fills the dataset table with rows that are returned from an SQL statement. Now let's look at the SQL statement that is executed by the `Fill` method. In the *Solution Explorer*, you should see an entry named *ProductDataSet.xsd*, as shown in Figure 11-71. This is the **schema definition file** that describes the contents of the `productDataSet`. Double-click the *ProductDataSet.xsd* entry to open it in an editor window, as shown in Figure 11-72. The area at the top of the diagram shows the columns that are included in the dataset, and the area at the bottom shows the table adapter query methods.

**Figure 11-71** Schema definition file entry in the *Solution Explorer*

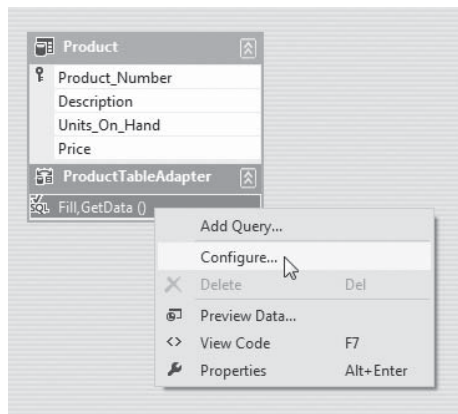


Right-click the area that reads *Fill, GetData()* and, as shown in Figure 11-73, select *Configure* from the pop-up menu. This displays the *TableAdapter Configuration Wizard* window shown in Figure 11-74. Notice the SQL query that appears in *TableAdapter Configuration Wizard* window. The dataset is filled with the rows that are returned by this `select` statement. If you were to change this `select` statement, for instance, by adding a `where` clause and then by clicking the *Finish* button, the data that is initially

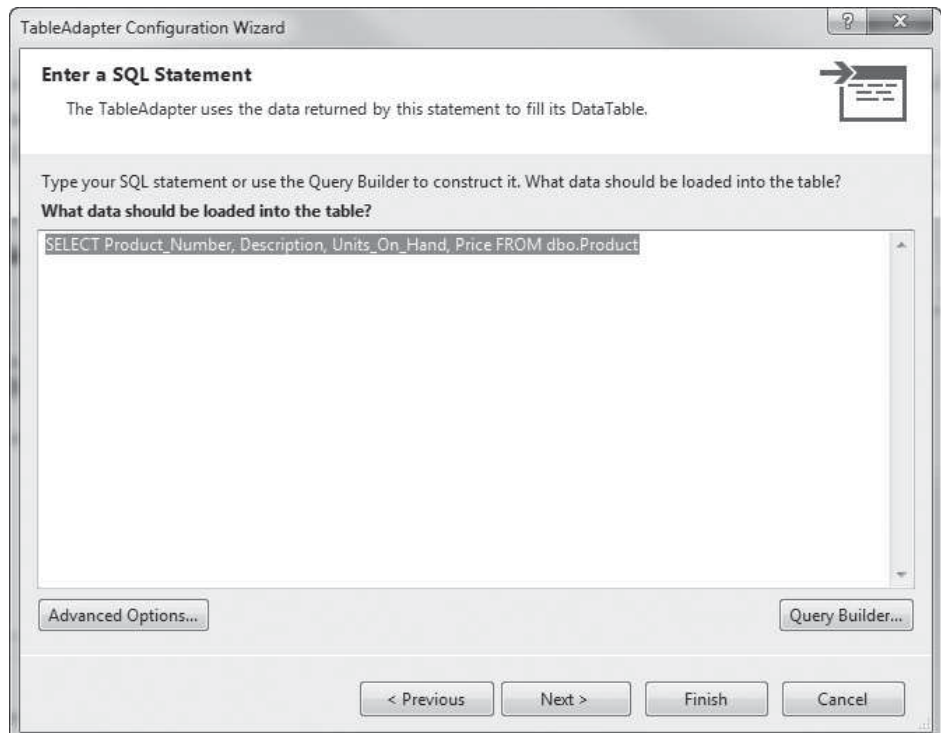
**Figure 11-72** ProductDataSet.xsd opened for editing



**Figure 11-73** Select *Configure* from the pop-up menu



**Figure 11-74** TableAdapter Configuration Wizard



displayed in the DataGridView control would change accordingly. When you are finished examining the window, click the *Cancel* button to close it.



**NOTE:** Notice that the table name in the `select` statement is preceded with the `dbo.` prefix. The prefix `dbo` stands for database owner and is part of an SQL Server naming convention. In our example programs, the `dbo` prefix is optional.

## Adding New Table Adapter Queries

You can add your own SQL queries to a table adapter and call them from your C# code. In Tutorial 11-6 you add several queries to a table adapter, and then you create buttons on the application's form that executes those queries.



VideoNote

VideoNote:  
**Tutorial 11-6:**  
Creating  
the *Product  
Queries*  
Application



### Tutorial 11-6: Creating the *Product Queries* Application

In this tutorial you create an application that displays the `Product` table from the `ProductDB.mdf` database in a DataGridView control. You also add two SQL queries to the table adapter. The queries perform the following:

- Return all the rows, sorted by price in ascending order
- Return only the rows with more than 100 units on hand

Then, you create buttons on the applications form that execute the queries.

**Step 1:** Start Visual Studio (or Visual Studio Express). Create a new *Windows Forms Application* project named *Product Queries*.

**Step 2:** Change the Form1 form's Text property to *Product Queries*.

**Step 3:** Perform the following steps to connect the application to the `ProductDB.mdf` database and select the `Product` table for the dataset:

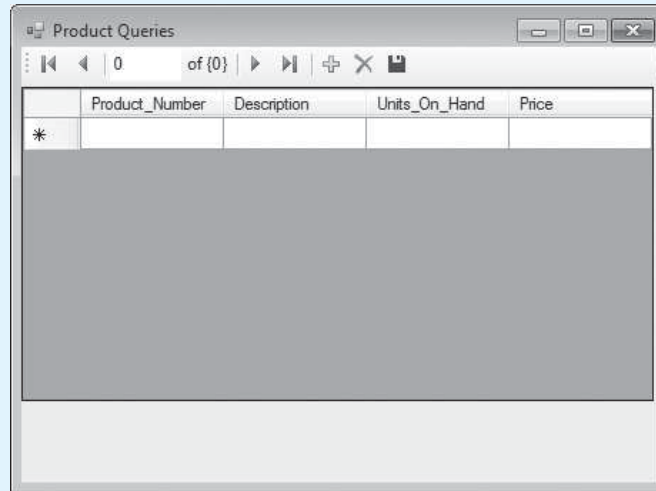
- From the *PROJECT* menu, select *Add New Data Source...*
- Select *Database* and click *Next >*.
- Select *Dataset* and click *Next >*.
- Click *New Connection...*
- In the *Add Connection* window, make sure *Microsoft SQL Server Database File (SqlClient)* is the selected data source.
- In the *Add Connection* window, click *Browse* and go to the *Chap11* folder in the Student Sample Programs. Select the *ProductDB.mdf* file. Click *OK*.
- Click *Next >*, and when asked if you want to copy the file to the project, click *Yes*.
- Click *Next >*.
- Select the `Product` table as the database object, and change the name of the dataset to `ProductDataSet`. Click *Finish*.



**NOTE:** This is the same procedure that you performed in Steps 3–11 in Tutorial 11-3. If you want more detailed guidance, go back to that tutorial to see the actual screens.

**Step 4:** Open the *Data Sources* window and drag a `DataGridView` control onto the form, bound to the `Product` table. After creating the `DataGridView` control, adjust the size of the form and the control, as shown in Figure 11-75.

**Figure 11-75** The application's form

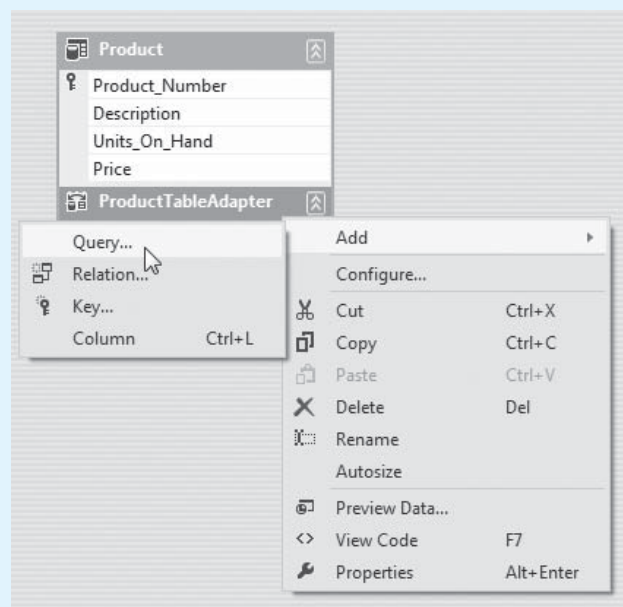


**Step 5:** Now you add the first query, which sorts the data in the dataset by price. In the *Solution Explorer*, double-click the *ProduceDataSet.xsd* entry. This opens the dataset schema description. Right-click the area that reads *ProductTableAdapter*. As shown in Figure 11-76, select *Add*, and then click *Query....*



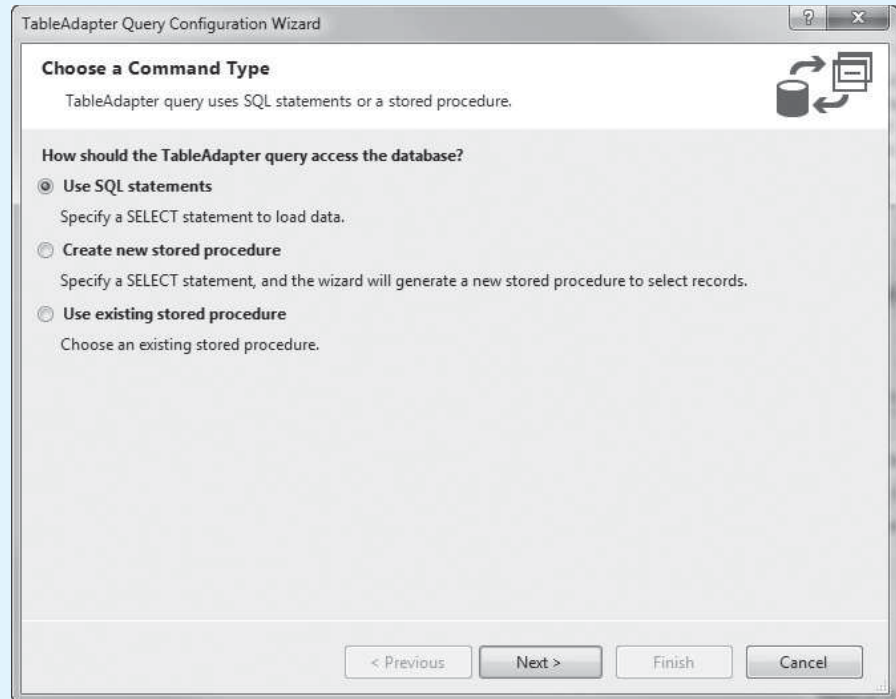
**NOTE:** It is possible that you will see *Add Query...* on the pop-up menu instead of *Add*. If that is the case, simply click *Add Query....*

**Figure 11-76** Adding a query to the table adapter



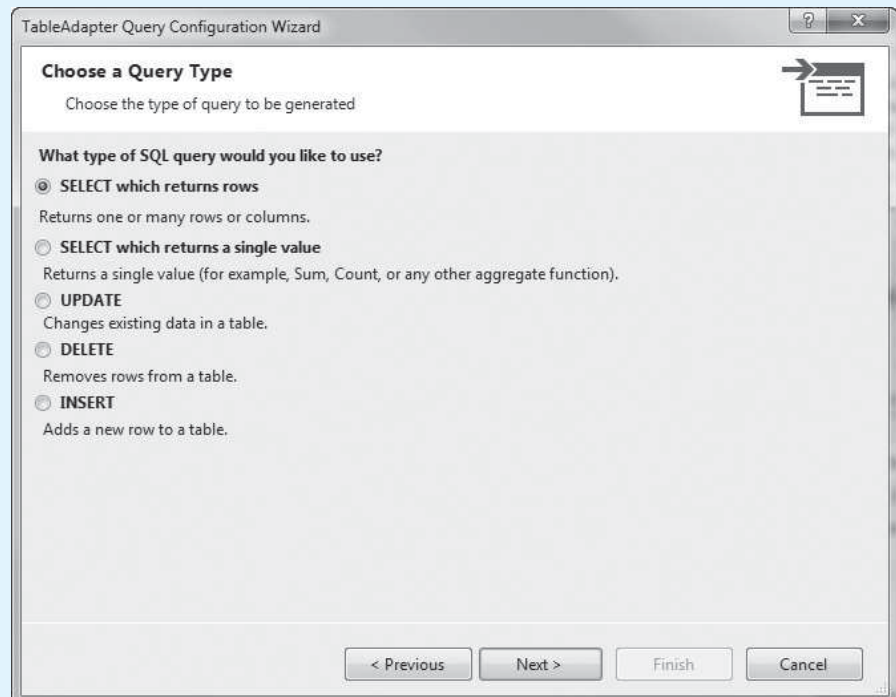
**Step 6:** The *TableAdapter Query Configuration Wizard* appears next, as shown in Figure 11-77. Make sure *Use SQL Statements* is selected, and then click *Next >*.

**Figure 11-77** *TableAdapter Query Configuration Wizard—Choose a Command Type*



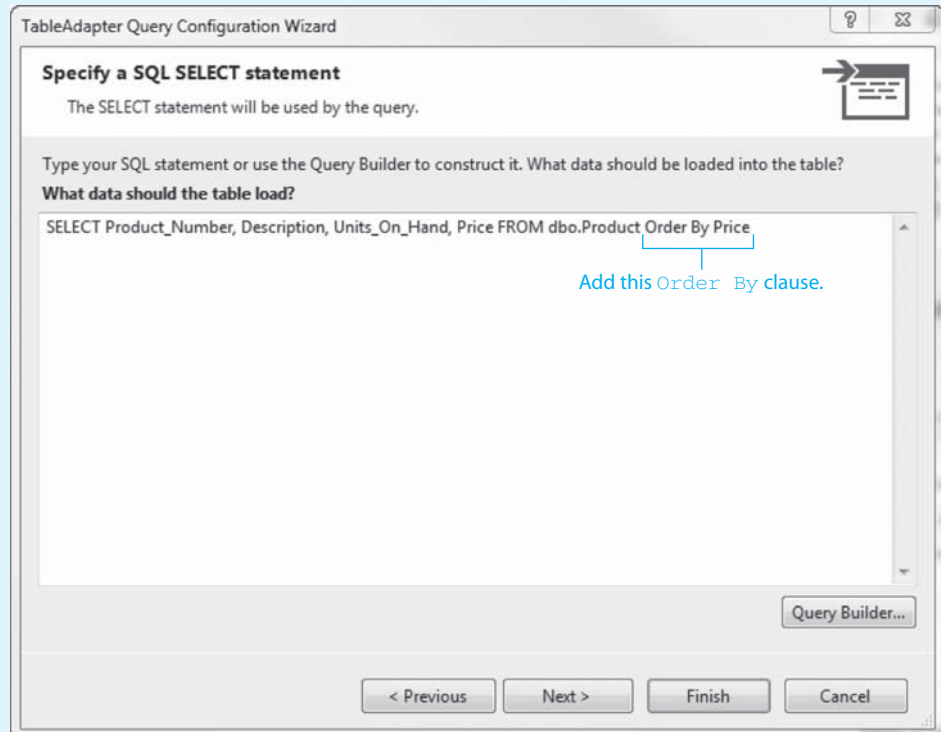
**Step 7:** The wizard now prompts you to choose a query type, as shown in Figure 11-78. Make sure *SELECT which returns rows* is selected, and then click *Next >*.

**Figure 11-78** *TableAdapter Query Configuration Wizard—Choose a Query Type*



**Step 8:** The wizard now prompts you to *Specify a SQL SELECT statement*. A statement is already shown that returns every row in the `Product` table. Add the `Order By Price` clause to the end of the statement, as shown in Figure 11-79. Click *Next >*.

**Figure 11-79** *TableAdapter Query Configuration Wizard—Specify a SQL SELECT statement*



**Step 9:** The wizard now prompts you to *Choose Methods to Generate*. We are interested only in generating a method to fill the dataset with the results of our SQL statement. Make the following selections:

- Make sure *Fill a DataTable* is checked.
- Under *Fill a DataTable*, enter `FillByPrice` as the method name. This will be the name of the method that executes the SQL statement.
- Make sure *Return a DataTable* is not checked.

The window should now appear as shown in Figure 11-80. Click *Next >*.

**Step 10:** The wizard now shows you the results, as shown in Figure 11-81. Click the *Finish* button.

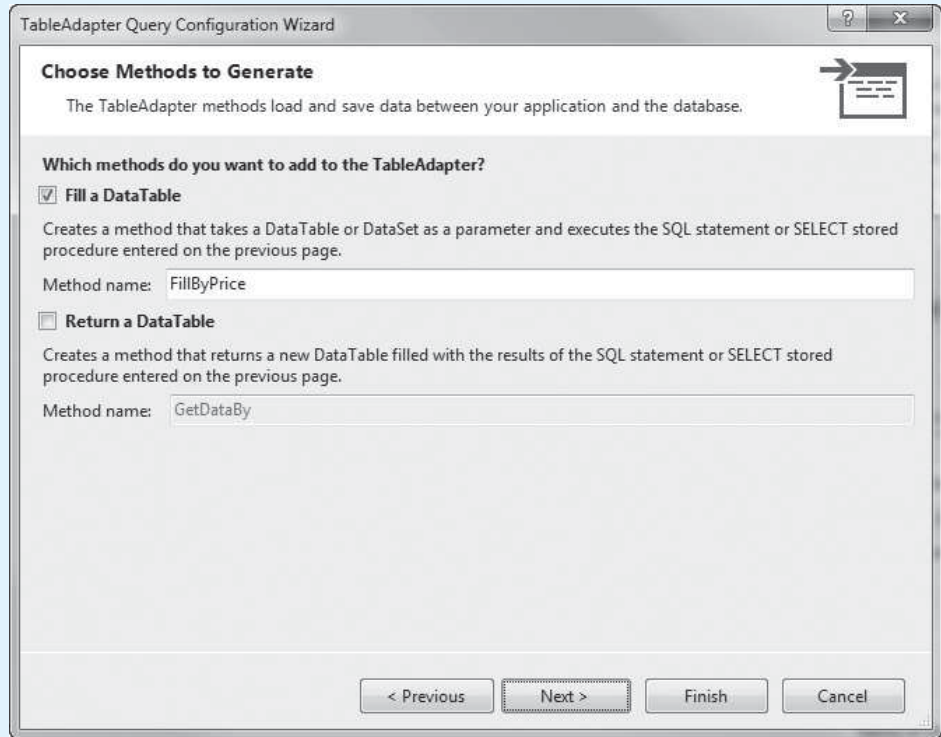
The schema definition file (`ProductDataSet.xsd`) should now appear as shown in Figure 11-82. Notice that the method `FillByPrice()` now appears in the area at the bottom of the diagram.



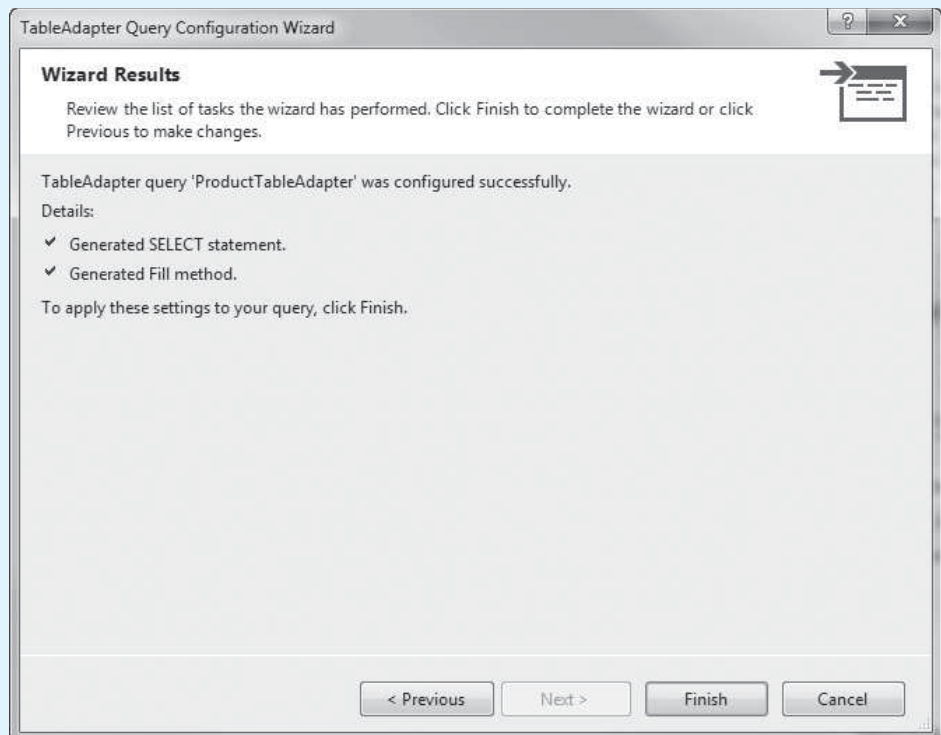
**NOTE:** After you have created a table adapter query, you can edit it by right-clicking its entry in the dataset schema definition and then clicking *Configure . . .* from the pop-up menu.

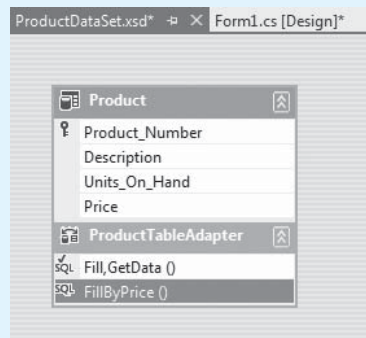


**Figure 11-80** *TableAdapter Query Configuration Wizard—Choose Methods to Generate*



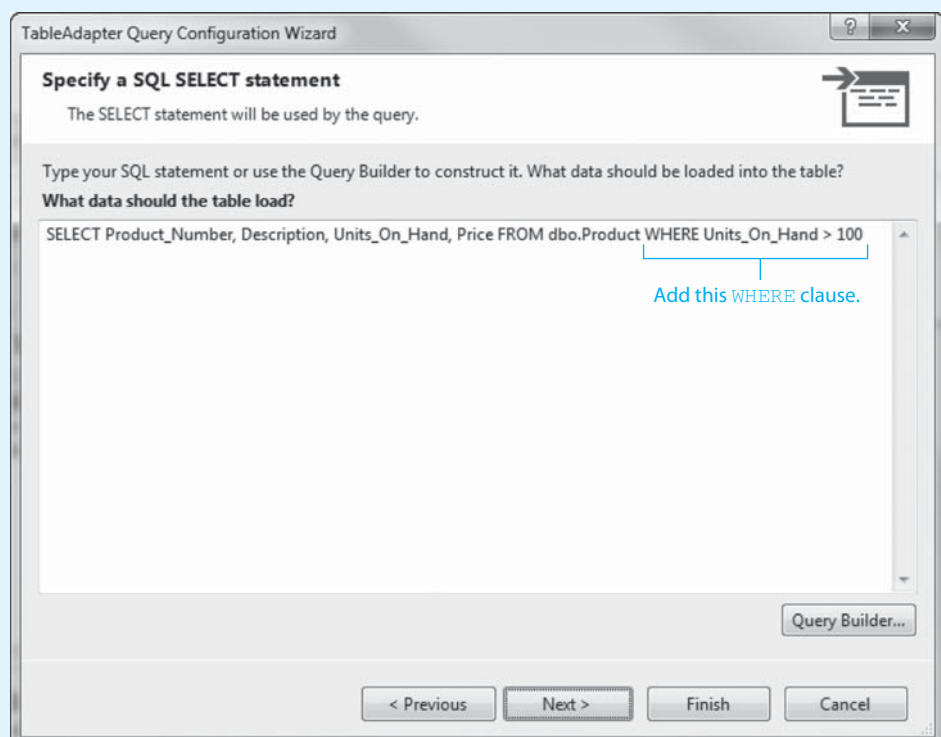
**Figure 11-81** *TableAdapter Query Configuration Wizard—Wizard Results*



**Figure 11-82** The `FillByPrice()` method appearing in the schema definition file

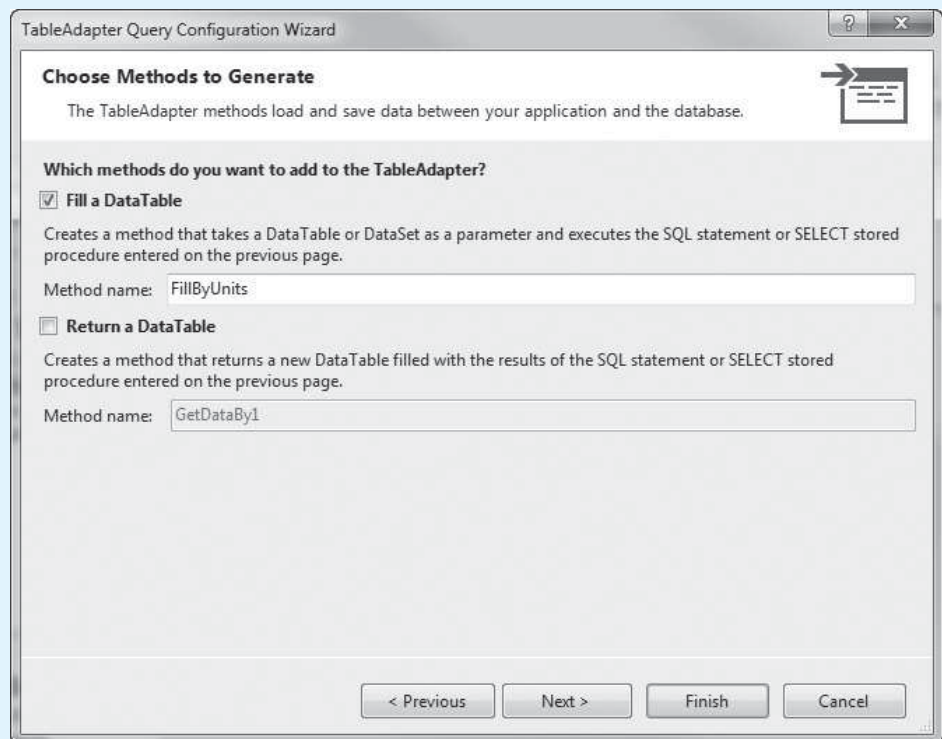
**Step 11:** Next you add the second query, which returns only the rows with units on hand greater than 100. Perform the following steps (most of these are the same as those you performed to add the previous query):

- In the schema definition, right-click the area that reads *ProductTableAdapter*.
- In the pop-up menu, select *Add*, and then click *Query. . .* (Or, if you see *Add Query. . .*, then select that.)
- The *TableAdapter Query Configuration Wizard* appears next. Make sure *Use SQL Statements* is selected and then click *Next >*.
- The wizard now prompts you to choose a query type. Make sure *SELECT which returns rows* is selected and then click *Next >*.
- The wizard now prompts you to *Specify a SQL SELECT statement*. A statement is already shown that returns every row in the *Product* table. Add the `WHERE Units_On_Hand > 100` clause to the end of the statement, as shown in Figure 11-83. Click *Next >*.

**Figure 11-83** *TableAdapter Query Configuration Wizard—Specify a SQL SELECT statement*

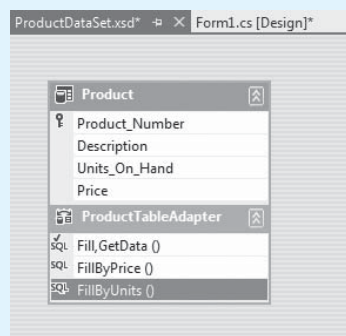
- The wizard now prompts you to *Choose Methods to Generate*. Make the following selections:  
 Make sure *Fill a DataTable* is checked.  
 Under *Fill a DataTable*, enter `FillByUnits` as the method name. This will be the name of the method that executes the SQL statement.  
 Make sure *Return a DataTable* is not checked.
- The window should now appear as shown in Figure 11-84. Click *Next >*.
- The wizard now shows you the results. Click the *Finish* button.

**Figure 11-84** *TableAdapter Query Configuration Wizard—Choose Methods to Generate*



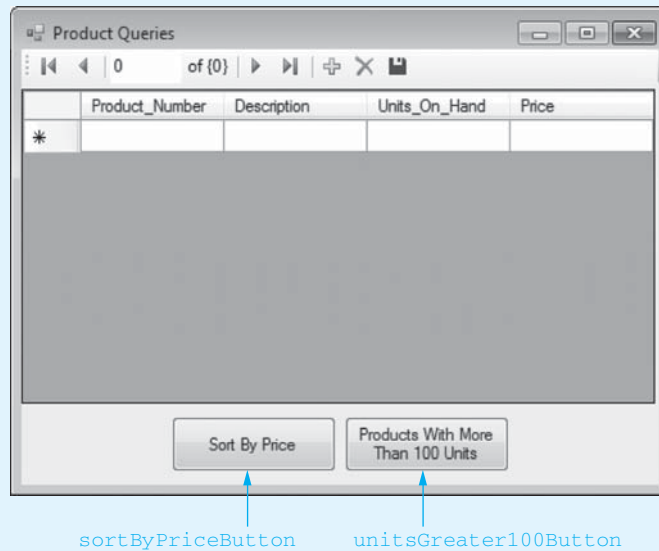
The schema definition file (`ProductDataSet.xsd`) should now appear as shown in Figure 11-85. Notice that the two methods you created, `FillByPrice()` and `FillByUnits()`, now appear in the area at the bottom of the diagram.

**Figure 11-85** The `FillByPrice()` and `FillByUnits()` methods as they appear in the schema definition file



**Step 12:** Now you add Button controls to the application's form that execute the SQL queries. Open Form1 in the *Designer* and add the two Button controls shown in Figure 11-86.

**Figure 11-86** Button controls added to the form



**Step 13:** Double-click the `sortByPriceButton` control. Complete `sortByPriceButton_Click` the event handler by typing the code in line 37 in Program 11-4. This statement calls the table adapter's `FillByPrice` method.

**Step 14:** Switch your view back to Form1 in the *Designer* and double-click the `unitsGreater100Button` control. Complete `unitsGreater100Button_Click` event handler by typing the code in line 42 in Program 11-4. This statement calls the table adapter's `FillByUnits` method.

**Step 15:** Save the project, and then run the application. When the form appears, it should show all the `Product` table's rows in the `DataGridView` control. When you click the *Sort By Price* button, the data should appear sorted by price. When you click the *Products With More Than 100 Units* button, you should see only the rows where `Units_On_Hand` is greater than 100. When you are finished, close the application's form to exit. (If you plan to immediately continue to the next tutorial, leave the project opened in Visual Studio. You continue to develop this application in the next tutorial.)

**Program 11-4** Completed Form1 code in the *Product Queries* application

```

1 using System;
2 using System.Collections.Generic;
3 using System.ComponentModel;
4 using System.Data;
5 using System.Drawing;
6 using System.Linq;
7 using System.Text;
8 using System.Threading.Tasks;
9 using System.Windows.Forms;

```

```

10
11 namespace Product_Queries
12 {
13     public partial class Form1 : Form
14     {
15         public Form1()
16         {
17             InitializeComponent();
18         }
19
20         private void productBindingNavigatorSaveItem_Click(object sender, EventArgs e)
21         {
22             this.Validate();
23             this.productBindingSource.EndEdit();
24             this.tableAdapterManager.UpdateAll(this.productDataSet);
25
26         }
27
28         private void Form1_Load(object sender, EventArgs e)
29         {
30             // TODO: This line of code loads data into the ...
31             this.productTableAdapter.Fill(this.productDataSet.Product);
32
33         }
34
35         private void sortByPriceButton_Click(object sender, EventArgs e)
36         {
37             this.productTableAdapter.FillByPrice(this.productDataSet.Product);
38         }
39
40         private void unitsGreater100Button_Click(object sender, EventArgs e)
41         {
42             this.productTableAdapter.FillByUnits(this.productDataSet.Product);
43         }
44     }
45 }

```

## SQL Math Functions

SQL provides several functions for performing calculations. For example, the `Avg` function calculates the average value in a particular column. Here is an example `Select` statement using the `Avg` function:

```
Select Avg(Price) From Product
```

This statement produces a single value: the average of all the values in the `Price` column. Because we did not use a `Where` clause, it uses all the rows in the `Product` table in the calculation. Here is an example that calculates the average price of all the items having a product number that begins with "20":

```
Select Avg(Price)From Product Where Product_Number LIKE '20%'
```

Another of the mathematical functions is `Sum`, which calculates the sum of a column's values. The following statement, which is probably not very useful, calculates the sum of the values in the `Price` column:

```
Select Sum(Price) From Product
```

The `Min` and `Max` functions determine the minimum and maximum values found in a column. The following statement gives the minimum value in the `Price` column:

```
Select Min(Price) From Product
```

The following statement gives the maximum value in the `Price` column:

```
Select Max(Price) From Product
```

The `Count` function can be used to determine the number of rows in a table, as demonstrated by the following statement:

```
Select Count(*) From Product
```

The `*` simply indicates that you want to count entire rows. Here is another example, which gives the number of items with a price greater than 50.0:

```
Select Count(*) From Product Where Price > 50.0
```

In Tutorial 11-7 you will add another query to the table adapter in the *Product Queries* application. The new query will display average price of all the items in the database.



## Tutorial 11-7: Creating the *Product Queries* Application



VideoNote

**Tutorial 11-7:**  
Creating the *Product Queries* Application

In this tutorial you add a query to the *Product Queries* application that returns the average price of all the items in the `Product` table. You also add a button to the application's form that executes the query and displays its result.

- Step 1:** Make sure the *Product Queries* project is open in Visual Studio (or Visual Studio Express) from the previous tutorial.
- Step 2:** In the *Solution Explorer*, double-click the *ProduceDataSet.xsd* entry. This opens the dataset schema description. Right-click the area that reads *ProductTableAdapter*. In the pop-up menu, select *Add* and then click *Query...* (Or, if you see *Add Query...* on the pop-up menu, select it.)
- Step 3:** The *TableAdapter Query Configuration Wizard* appears next. Make sure *Use SQL Statements* is selected and then click *Next >*.
- Step 4:** The wizard now prompts you to choose a query type. Make sure *SELECT which returns a single value* is selected and then click *Next >*.
- Step 5:** The wizard now prompts you to *Specify a SQL SELECT statement*. Delete the statement currently shown in the window and replace it with the following:

```
Select Avg(Price) From Product
```

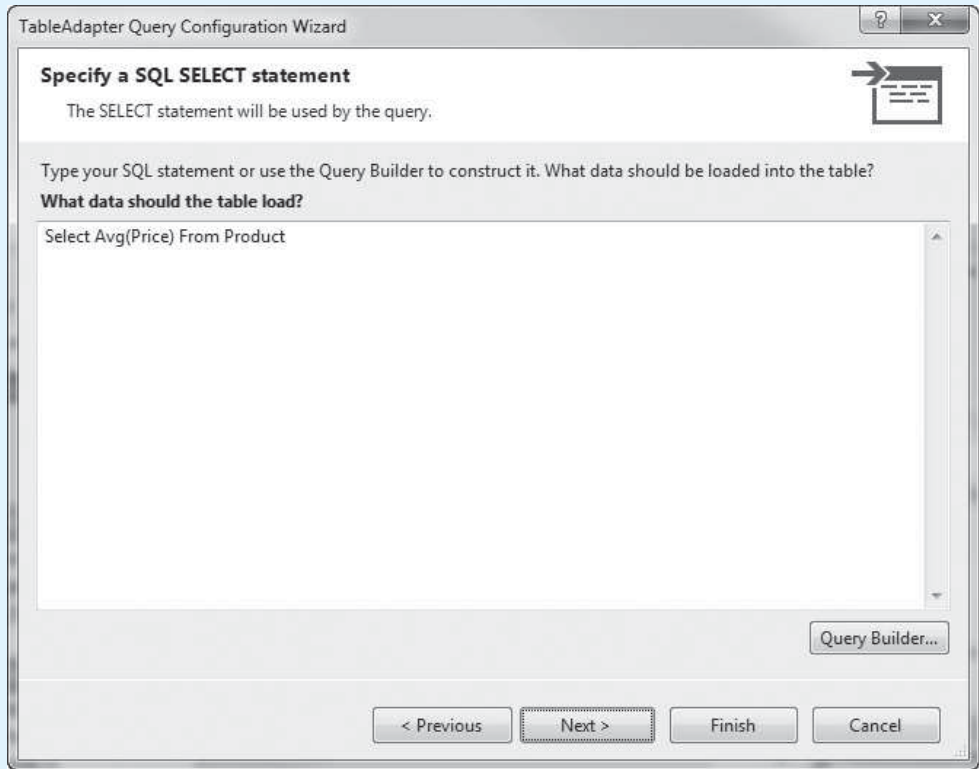
The window should appear as shown in Figure 11-87. Click *Next >*.

- Step 6:** The wizard now prompts you to *Choose Function Name*. The name that you specify in this window will be the name of the method that executes the query. As shown in Figure 11-88, change the name to `AveragePrice` and then click *Next >*.

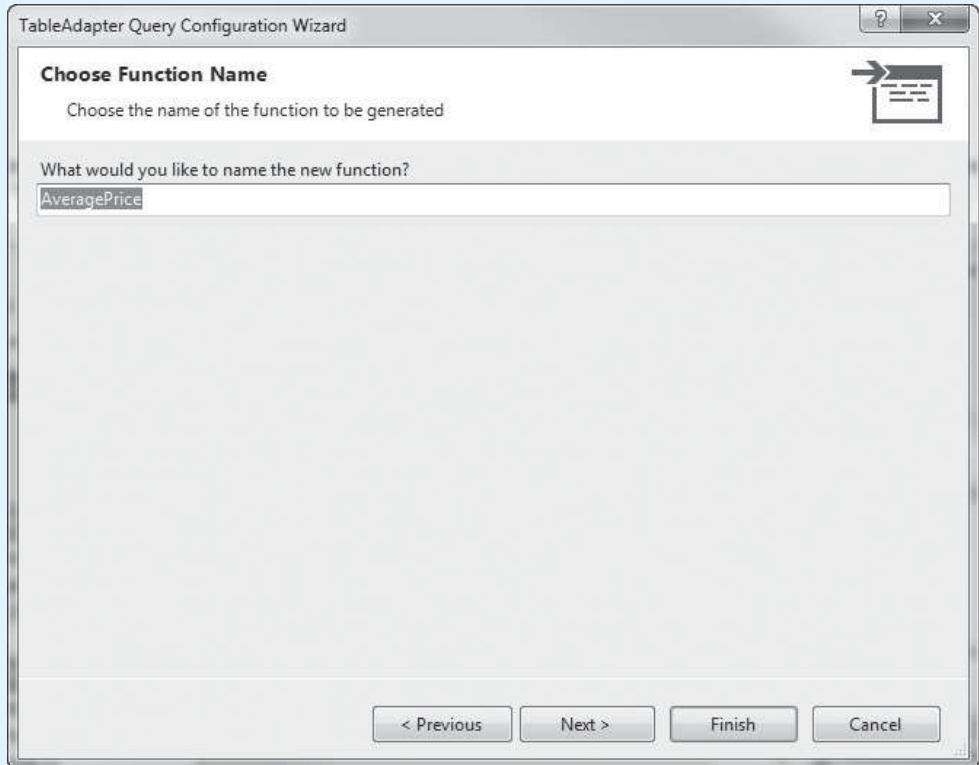
- Step 7:** The wizard now shows you the results. Click the *Finish* button.

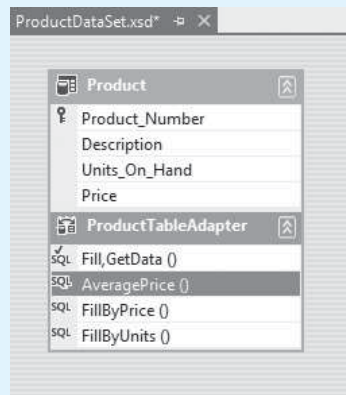
The schema definition file (*ProductDataSet.xsd*) should now appear, as shown in Figure 11-89. Notice that the `AveragePrice` method appears, along with the other methods that you previously created.

**Figure 11-87** TableAdapter Query Configuration Wizard—Specify a SQL SELECT statement

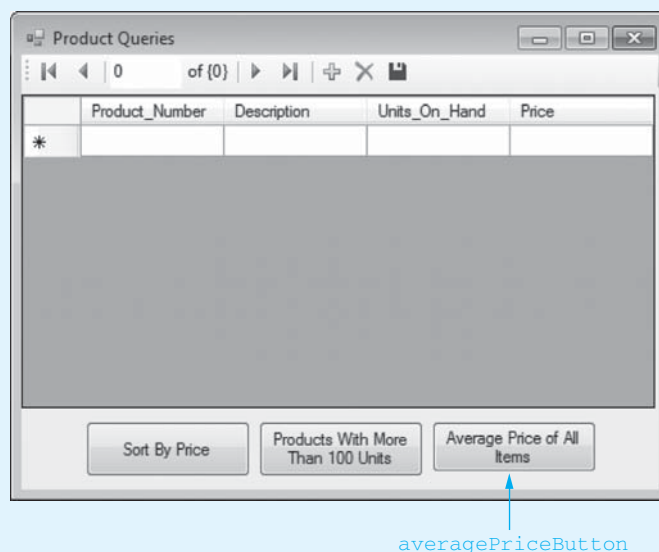


**Figure 11-88** TableAdapter Query Configuration Wizard—Choose Function Name



**Figure 11-89** The `AveragePrice()` method as it appears in the schema definition file

**Step 8:** Next you add a Button control to the application's form that executes the table adapter's `AveragePrice` method. Open `Form1` in the *Designer* and the `averagePriceButton` control shown in Figure 11-90.

**Figure 11-90** The `averagePriceButton` control added to the form

**Step 9:** Double-click the `averagePriceButton` control. Complete the `averagePriceButton_Click` event handler by typing the code in lines 47–55 in Program 11-5. Let's take a closer look at the code:

**Line 48:** This statement declares a local `decimal` variable named `averagePrice`.

**Line 51:** This statement calls the table adapter's `AveragePrice` method, which returns the result of the `select` statement that you wrote in Step 4. The value that is returned is assigned to the `averagePrice` variable. Notice that we had to use a cast operator to explicitly convert the value to a `decimal`.

**Lines 54–55:** This statement displays a message box showing the average price of all items in the table.



**Step 10:** Save the project and then run the application. Click the *Average Price of All Items* button. You should see a message box displaying a message indicating the average price of all the items. When you are finished, close the application's form to exit.

---

**Program 11-5** Completed Form1 code in the *Product Queries* application

```

1 using System;
2 using System.Collections.Generic;
3 using System.ComponentModel;
4 using System.Data;
5 using System.Drawing;
6 using System.Linq;
7 using System.Text;
8 using System.Threading.Tasks;
9 using System.Windows.Forms;
10
11 namespace Product_Queries
12 {
13     public partial class Form1 : Form
14     {
15         public Form1()
16         {
17             InitializeComponent();
18         }
19
20         private void productBindingNavigatorSaveItem_Click(object sender, EventArgs e)
21         {
22             this.Validate();
23             this.productBindingSource.EndEdit();
24             this.tableAdapterManager.UpdateAll(this.productDataSet);
25
26         }
27
28         private void Form1_Load(object sender, EventArgs e)
29         {
30             // TODO: This line of code loads data into the ...
31             this.productTableAdapter.Fill(this.productDataSet.Product);
32
33         }
34
35         private void sortByPriceButton_Click(object sender, EventArgs e)
36         {
37             this.productTableAdapter.FillByPrice(this.productDataSet.Product);
38         }
39
40         private void unitsGreater100Button_Click(object sender, EventArgs e)
41         {
42             this.productTableAdapter.FillByUnits(this.productDataSet.Product);
43         }
44
45         private void averagePriceButton_Click(object sender, EventArgs e)
46         {
47             // Declare a variable to hold the average price.
48             decimal averagePrice;
49
50             // Get the average price.
51             averagePrice = (decimal) this.productTableAdapter.AveragePrice();

```

```

52
53         // Display the average price.
54         MessageBox.Show("Average price of all items: " +
55             averagePrice.ToString("c"));
56     }
57 }
58 }

```

## Query Parameters

SQL queries can accept arguments. Just as with regular methods, arguments are passed into parameter variables. In an SQL statement, a parameter variable begins with the @ symbol. The following statement shows an example:

```
Select * From Product Where Price < @priceValue
```

This statement retrieves all the rows in which the `Price` column is less than the value of the `priceValue` parameter. Here is another example:

```
Select * From Product
Where Price < @priceValue And Units_On_Hand < @unitsValue
```

This statement retrieves all the rows in which the `Price` column is less than the value of the `@priceValue` parameter and the `Units_On_Hand` column is less than the value of the `@unitsValue` parameter.

When you call the table adapter method for an SQL query, you have to pass arguments for any parameters that are used in the query. In Tutorial 11-8 you create an application that gets a value from the user and passes that value as an argument to an SQL query.



### Tutorial 11-8:

#### Creating the *Product Search* Application

In this tutorial you create an application that displays the `Product` table from the `ProductDB.mdf` database in a `DataGridView` control. The user will be able to enter a value into a text box and search for all items that contain that value in their description.

**Step 1:** Start Visual Studio (or Visual Studio Express). Create a new *Windows Forms Application* project named *Product Search*.

**Step 2:** Change the `Form1` form's `Text` property to *Product Search*.

**Step 3:** Perform the following steps to connect the application to the `ProductDB.mdf` database and select the `Product` table for the dataset:

- From the *PROJECT* menu, select *Add New Data Source....*
- Select *Database* and click *Next >*.
- Select *Dataset* and click *Next >*.
- Click *New Connection....*
- In the *Add Connection* window, make sure *Microsoft SQL Server Database File (SqlClient)* is the selected data source.
- In the *Add Connection* window, click *Browse* and go to the *Chap11* folder in the Student Sample Programs. Select the *ProductDB.mdf* file. Click *OK*.
- Click *Next >*, and when asked if you want to copy the file to the project, click *Yes*.



VideoNote

**Tutorial 11-8:**  
Creating  
the *Product  
Search*  
Application

- Click *Next* >.
- Select the `Product` table as the database object, and change the name of the dataset to `ProductDataSet`. Click *Finish*.



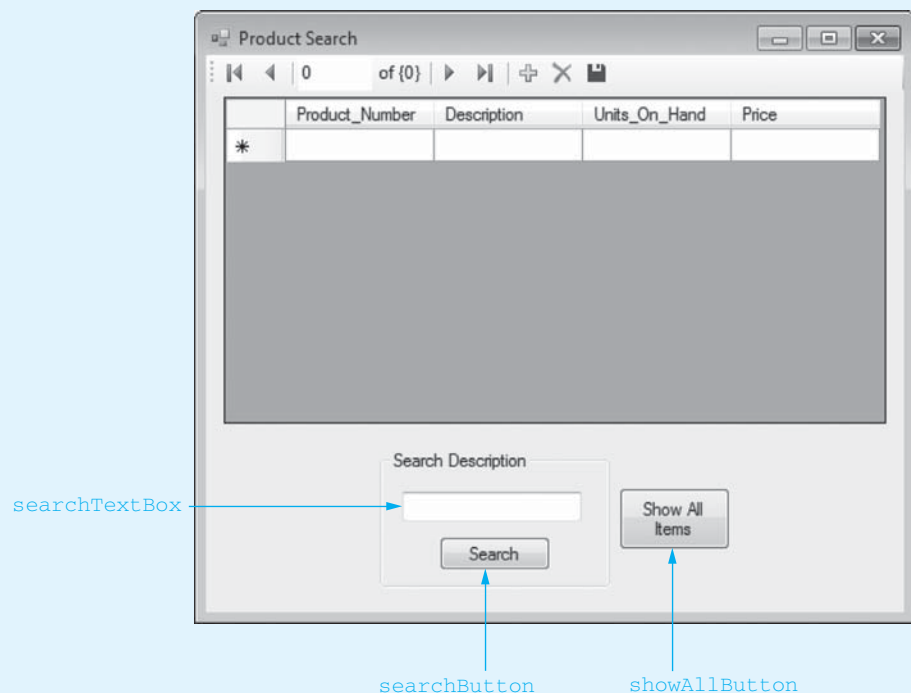
**NOTE:** This is the same procedure that you performed in Steps 3–11 in Tutorial 11-3. If you want more detailed guidance, go back to that tutorial to see the actual screens.

**Step 4:** Open the *Data Sources* window and drag a `DataGridView` control onto the form, bound to the `Product` table.

**Step 5:** Adjust the size of the form and the `DataGridView` control, as shown in Figure 11-91. Then, place the group box, text box, and buttons as shown in the figure. Here is a summary of what the `Button` controls will do when the application is completed:

- The `searchButton` control will get the value that has been entered into the `searchTextBox` and pass that as an argument to an SQL query. The query will return all rows in the `Product` table that contain the value that was passed as an argument. Those rows will be displayed in the `DataGridView` control.
- The `showAllButton` will display all the rows of the `Product` table in the `DataGridView` control.

**Figure 11-91** The application's form



**Step 6:** In the *Solution Explorer*, double-click the `ProduceDataSet.xsd` entry. This opens the dataset schema description. Right-click the area that reads `Product-TableAdapter`. In the pop-up menu, select *Add* and then click *Query. . .* (Or, if you see *Add Query. . .* on the pop-up menu, select it.)

**Step 7:** The *TableAdapter Query Configuration Wizard* appears next. Make sure *Use SQL Statements* is selected and then click *Next >*.

**Step 8:** The wizard now prompts you to choose a query type. Make sure *SELECT which returns rows* is selected and then click *Next >*.

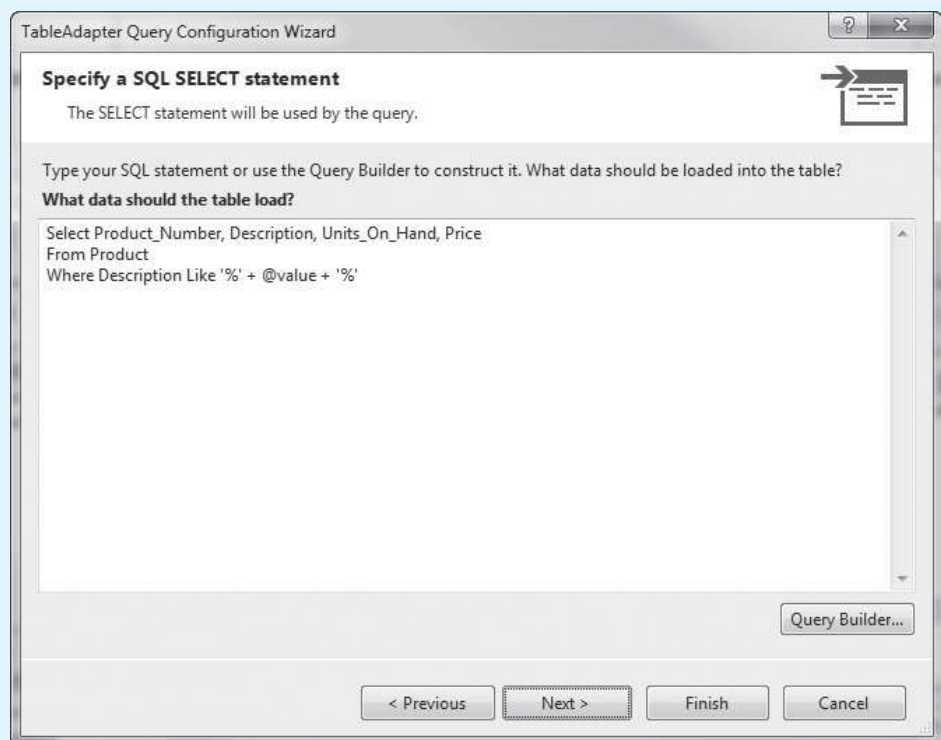
**Step 9:** The wizard now prompts you to *Specify a SQL SELECT statement*. Modify the default statement that is provided as shown here:

```
Select Product_Number, Description, Units_On_Hand, Price
From Product
Where Description Like '%' + @value + '%'
```

Notice that a parameter query named @value is used in the *where* clause. Also, notice the use of the + operator for string concatenation. When this query executes, it will return all rows in which the *Description* column contains the value specified by the @value parameter. The window at this point should appear as shown in Figure 11-92.

Click *Next >*.

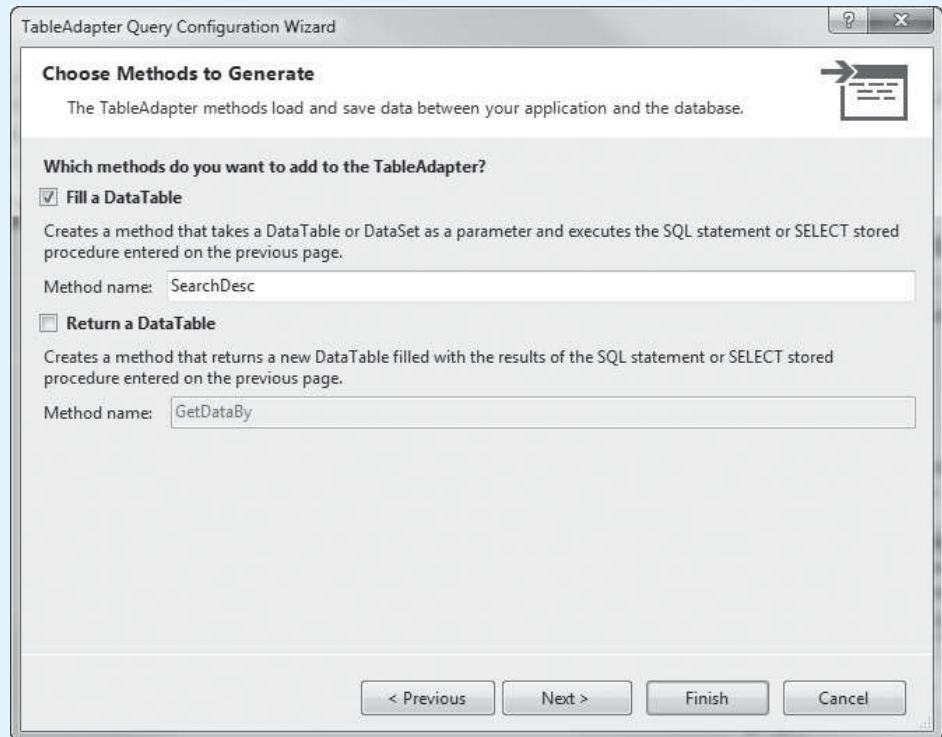
**Figure 11-92** *TableAdapter Query Configuration Wizard—Specify a SQL SELECT statement*



**Step 10:** The wizard now prompts you to *Choose Methods to Generate*. Make the following selections:

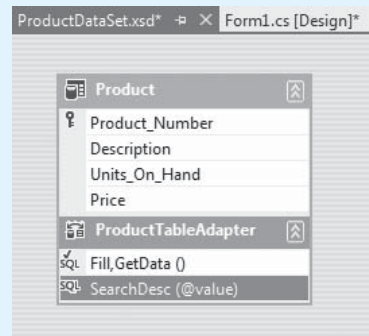
- Make sure *Fill a DataTable* is checked.
- Under *Fill a DataTable*, enter *SearchDesc* as the method name. This will be the name of the method that executes the SQL statement.
- Make sure *Return a DataTable* is not checked.

The window should now appear as shown in Figure 11-93. Click *Next >*.

**Figure 11-93** TableAdapter Query Configuration Wizard—Choose Methods to Generate

**Step 11:** The wizard now shows you the results. Click the *Finish* button.

The schema definition file (ProductDataSet.xsd) should now appear as shown in Figure 11-94. Notice that the `SearchDesc (@value)` now appears in the area at the bottom of the diagram.

**Figure 11-94** The `searchDesc` method appearing in the schema definition file

**Step 12:** Open Form1 in the *Designer* and double-click the `searchButton` control. Complete the `searchButton_Click` event handler by typing the code shown in lines 37 and 38 in Program 11-6.

The statement in these lines calls the table adapter's `SearchDesc` method. The first argument is the dataset's `Product` table, and the second argument is the

searchTextBox control's Text property. The second argument will be passed into the SQL query's @value parameter.

**Step 13:** Switch your view back to Form1 in the *Designer* and double-click the showAllButton control. Complete the showAllButton\_Click event handler by typing the code shown in line 43 in Program 11-6. The statement this line calls the table adapter's Fill method. Recall that the Fill method fills the dataset table with all of the rows from the table.

**Step 14:** Save the project and then run the application. Enter a search term, such as *Shirt* or *Pants*, in the text box and click the *Search* button. You should see all the rows that contain that search term displayed in the DataGridView control. To reset the DataGridView control so it displays all of the rows, click the *Show All Items* button. Experiment with several search terms. When you are finished, close the application.

---

### Program 11-6 Completed Form1 code in the *Product Search* application

```

1 using System;
2 using System.Collections.Generic;
3 using System.ComponentModel;
4 using System.Data;
5 using System.Drawing;
6 using System.Linq;
7 using System.Text;
8 using System.Threading.Tasks;
9 using System.Windows.Forms;
10
11 namespace Product_Search
12 {
13     public partial class Form1 : Form
14     {
15         public Form1()
16         {
17             InitializeComponent();
18         }
19
20         private void productBindingNavigatorSaveItem_Click(object sender, EventArgs e)
21         {
22             this.Validate();
23             this.productBindingSource.EndEdit();
24             this.tableAdapterManager.UpdateAll(this.productDataSet);
25
26         }
27
28         private void Form1_Load(object sender, EventArgs e)
29         {
30             // TODO: This line of code loads data into the ...
31             this.productTableAdapter.Fill(this.productDataSet.Product);
32
33         }
34
35         private void searchButton_Click(object sender, EventArgs e)
36         {
37             this.productTableAdapter.SearchDesc(
38                 this.productDataSet.Product, searchTextBox.Text);
39         }
40

```

```
41     private void showAllButton_Click(object sender, EventArgs e)
42     {
43         this.productTableAdapter.Fill(this.productDataSet.Product);
44     }
45 }
46 }
```



### Checkpoint

- 11.23 In SQL, what is the purpose of the `select` statement?
- 11.24 What are the instructions for the DBMS to carry out operations on its data called?
- 11.25 How are the relational operators used in SQL different from those used in C#?
- 11.26 How do you write a single quote as part of a string in SQL?
- 11.27 What is the purpose of the `Like` operator in SQL?
- 11.28 How is the underscore character different from the `%` character in SQL?
- 11.29 How do you sort the results of a `select` query in SQL?
- 11.30 In an SQL statement, with what symbol does a query parameter begin?

## Key Terms

binding source	identity column
column	output folder
database	primary key
database management system (DBMS)	queries
data-bound control	row
DataGridView control	schema definition file
dataset	Select statement
data source	smart tag
DataSource property	structured query language (SQL)
Details view	table
DisplayMember property	table adapter
	table adapter query

## Review Questions

### Multiple Choice

1. A(n) \_\_\_\_\_ is software that is specifically designed to store, retrieve, and manipulate large amounts of data in an organized and efficient manner.
  - a. software development kit (SDK)
  - b. database management system (DBMS)
  - c. application programming interface (API)
  - d. driver development kit (DDK)
2. A \_\_\_\_\_ is a collection of tables that are stored using a database management system.
  - a. data source
  - b. dataset
  - c. database
  - d. spreadsheet
3. A \_\_\_\_\_ holds a collection of related data that is organized into rows and columns.
  - a. table
  - b. grid
  - c. dataset
  - d. worksheet
4. A \_\_\_\_\_ is a complete set of information about a single item in a table of a database.
  - a. data source
  - b. dataset
  - c. column
  - d. row
5. A(n) \_\_\_\_\_ holds an individual piece of information about the item in a row of a table in a database.
  - a. column
  - b. volume
  - c. record
  - d. entry



6. A \_\_\_\_\_ is a unique column value that can be used to identify a specific row in a table of a database.
  - a. data cell
  - b. primary key
  - c. prime column
  - d. lookup entry
7. A(n) \_\_\_\_\_ is a column that contains unique values that are generated by the DBMS.
  - a. generated column
  - b. pseudo-primary key
  - c. identity column
  - d. automatic entry
8. A \_\_\_\_\_ is a source of data with which the application can work.
  - a. database communicator
  - b. dataset
  - c. data source
  - d. parser
9. A \_\_\_\_\_ connects to a data source and can retrieve and update data from a table in a data source.
  - a. source connection
  - b. dataset
  - c. binding source
  - d. table adapter
10. A \_\_\_\_\_ gets a copy of a table from the table adapter and keeps the copy of the table in memory.
  - a. connection
  - b. dataset
  - c. read-only table
  - d. table adapter
11. A \_\_\_\_\_ is a component that can connect user interface controls directly to a dataset.
  - a. controller
  - b. source editor
  - c. binding source
  - d. component adapter
12. A \_\_\_\_\_ is a user interface control that is connected to a data source.
  - a. DBMS component
  - b. data-bound control
  - c. source control
  - d. database control
13. A \_\_\_\_\_ can display an entire database table in a scrollable grid on an application's form.
  - a. scrollable data control
  - b. Table control
  - c. SmartGrid control
  - d. DataGridView control

14. A \_\_\_\_\_ is a set of individual controls that are bound to the columns in a single row.
  - a. data-bound control set
  - b. data collection
  - c. Details view
  - d. Column view
15. In a Visual Studio project, the *bin\Debug* folder is known as the \_\_\_\_\_.
  - a. input folder
  - b. output folder
  - c. build folder
  - d. home folder
16. In the *Designer*, the \_\_\_\_\_ that appears in the upper-right corner of a control's bounding box can be clicked to display a tasks panel, which provides a number of options that can be performed with the control.
  - a. double arrow
  - b. smart tag
  - c. resizing handle
  - d. name
17. The \_\_\_\_\_ identifies the table from which to get data.
  - a. DataSource property
  - b. Table property
  - c. DataBound property
  - d. DataTable property
18. The \_\_\_\_\_ identifies the column of the table from which to display data.
  - a. DisplayData property
  - b. DataOutput property
  - c. ShowColumn property
  - d. DisplayMember property
19. \_\_\_\_\_, which stands for \_\_\_\_\_, is a standard language for working with database management systems.
  - a. SQL, structured query language
  - b. DBL, database language
  - c. XML, extensible markup language
  - d. HTML, hypertext markup language
20. \_\_\_\_\_ are instructions for the DBMS to carry out operations on its data.
  - a. Command strings
  - b. Queries
  - c. Build statements
  - d. Data tokens
21. In SQL, you use the \_\_\_\_\_ to retrieve the rows in a table.
  - a. `Select` statement
  - b. `Like` operator
  - c. `%` symbol
  - d. `where` clause
22. A(n) \_\_\_\_\_ is an SQL statement that is stored in a table adapter and can be executed simply by calling a method.
  - a. automated query
  - b. dataset query

- c. table adapter query
  - d. structured data query
23. The \_\_\_\_\_ describes the contents of a dataset, and its name appears in the *Solution Explorer* ending with the .xsd file extension.
- a. schema definition file
  - b. data markup file
  - c. table description file
  - d. DBMS protocol file

### True or False

1. When developing applications that work with an intensive amount of data, most developers prefer to use traditional files.
2. The DBMS works directly with the data and sends the results of operations back to the application.
3. The data that is stored in a database is organized into one or more tables.
4. Each column in a table must have a name.
5. When you create a database table, the data types that you can choose from are C# data types.
6. When working with the data in a database table, the column that is designated as the primary key must hold a unique value for each row.
7. If a column in a database table contains no data, it is said to be null.
8. An application works directly with a database, modifying rows, deleting rows, adding new rows, and so on.
9. Rather than showing multiple rows at once, a Details view lets the user see one row at a time.
10. SQL is a language that can be used to write data intensive applications.
11. String comparisons in SQL are case sensitive.

### Short Answer

1. In what situation do traditional files work well for storing data?
2. Briefly describe the layered nature of an application that works with a DBMS.
3. What is the data that is stored in a row of a table in a database divided into?
4. Are the data types used when creating a database table C# data types? If not, what kind of data types are they?
5. How do you create a primary key for a table with columns that could potentially contain the same values?
6. What type of columns in a database table must always contain a value?
7. Instead of working with the database directly, with what component does an application work?
8. What control can be used to display an entire database table in a scrollable grid on an application's form?
9. What is a Details view?
10. In SQL, what statement do you use to retrieve specific rows from a table in a database?
11. How do you sort the results of a `select` query in descending order in SQL?

### Algorithm Workbench

1. Look at the following SQL statement.

```
Select Name From Employee
```

- a. What is the name of the table from which this statement is retrieving data?
- b. What is the name of the column that is being retrieved?

For Questions 2–8, assume that a database has a table named *Stock*, with the following columns:

Column Name	Type
Trading_Symbol	nchar(10)
Company_Name	nchar(25)
Num_Shares	int
Purchase_Price	money
Selling_Price	money

2. Write a `Select` statement that returns all the columns from every row in the table.
3. Write a `Select` statement that returns only the `Trading_Symbol` column from every row in the table.
4. Write a `Select` statement that returns the `Trading_Symbol` column and the `Num_Shares` column from every row in the table.
5. Write a `Select` statement that returns the `Trading_Symbol` column only from the rows where `Purchase_Price` is greater than \$25.00.
6. Write a `Select` statement that returns all the columns from the rows where `Trading_Symbol` starts with "SU".
7. Write a `Select` statement that returns the `Trading_Symbol` column only from the rows where `Selling_Price` is greater than `Purchase_Price` and `Num_Shares` is greater than 100.
8. Write a `Select` statement that returns the `Trading_Symbol` column and the `Num_Shares` column only from the rows where `Selling_Price` is greater than `Purchase_Price` and `Num_Shares` is greater than 100. The results should be sorted by the `Num_Shares` column in ascending order.

## Programming Problems



VideoNote

Solving the  
Personnel  
Database  
Problem

1. **Personnel Database**

Use Visual Studio to create a database named `Personnel.mdf`. The database should have a table named `Employee`, with columns for employee ID, name, position, and hourly pay rate. The employee ID should be the primary key. Insert at least five sample rows of data into the `Employee` table. Create an application that displays the `Employee` table in a `DataGridView` control.

2. **Multiform Personnel Database Application**

Create an application that connects to the `Personnel.mdf` database that you created in Programming Problem 1. The application's main form should display the `Employee` table in a `DataGridView` control. The main form should also have a button

that, when clicked, displays a second form. The second form should display the `Employee` table in a Details view. Make sure that when the second form is closed, the main form refills the dataset so the most current data is displayed.

### 3. Hourly Pay Sorter

Create an application that connects to the `Personnel.mdf` database that you created in Programming Problem 1. The application's form should display the `Employee` table in a `DataGridView` control. The form should also have the following controls:

- A button that, when clicked, sorts the data in ascending order by hourly pay rate.
- A button that, when clicked, sorts the data in descending order by hourly pay rate.

### 4. Employee Search

Create an application that connects to the `Personnel.mdf` database that you created in Programming Problem 1. The application's form should display the `Employee` table in a `DataGridView` control. The application should let the user specify a name in a text box and then search for that name in the `Employee` table. The application should display any rows that contain a full or partial match of the specified name.

### 5. Highest and Lowest Pay Rate

Create an application that connects to the `Personnel.mdf` database that you created in Programming Problem 1. The application's form should display the `Employee` table in a `DataGridView` control. The form should also have the following controls:

- A button that, when clicked, displays a message indicating the highest (maximum) pay rate in the table.
- A button that, when clicked, displays a message indicating the lowest (minimum) pay rate in the table.

### 6. Population Database

In the *Chap11* folder of the Student Sample Programs, you will find a database file named `PopulationDB.mdf`. The database has a table named `City`. The `City` table has the following columns:

Column Name	Data Type
<code>City</code>	<code>nvarchar(50)</code> <i>Primary key</i>
<code>Population</code>	<code>float</code>

The `City` column stores the name of a city and the `Population` column stores the population of that city. The database has 20 rows already entered.

Create an application that connects to the `PopulationDB.mdf` database and allows the user to perform the following:

- Use data-bound controls to add new rows to the database, change existing rows, and delete rows.
- Sort the list of cities by population, in ascending order.
- Sort the list of cities by population, in descending order.
- Sort the list of cities by name.
- Get the total population of all the cities.
- Get the average population of all the cities.
- Get the highest population.
- Get the lowest population.

Data Type	Description
<code>bool</code>	A variable to store the Boolean values <code>true</code> and <code>false</code> .
<code>byte</code>	An unsigned 8-bit integer to store values in the range of 0 through 255.
<code>sbyte</code>	A signed 8-bit integer to store values in the range of $-128$ through 127.
<code>char</code>	A 16-bit variable to hold a Unicode character.
<code>decimal</code>	A 128-bit variable to hold real numbers, rounded to 28 digits of precision, in the range of $-7.9228 \times 10^{24}$ to $7.9228 \times 10^{24}$ .
<code>double</code>	A 64-bit variable to hold real numbers, rounded to 15 digits of precision, in the range of $\pm 5.0 \times 10^{2324}$ to $\pm 1.7 \times 10^{308}$ .
<code>float</code>	A 32-bit variable to hold real numbers rounded to 15 digits of precision, in the range of $-3.4 \times 10^{38}$ to $+3.4 \times 10^{38}$ .
<code>int</code>	A signed 32-bit integer to store values in the range of $-2,147,483,648$ through $2,147,483,647$ .
<code>uint</code>	An unsigned 32-bit integer to store values in the range of 0 through $4,294,967,295$ .
<code>long</code>	A signed 64-bit integer to store values in the range of $-9,223,372,036,854,775,808$ through $9,223,372,036,854,775,807$ .
<code>ulong</code>	An unsigned 64-bit integer to store values in the range of 0 through $18,446,744,073,709,551,615$ .
<code>short</code>	A signed 16-bit integer to store values in the range of $-32,768$ through $32,767$ .
<code>ushort</code>	An unsigned 16-bit integer to store values in the range of 0 through $65,535$ .
<code>string</code>	A variable to hold strings.

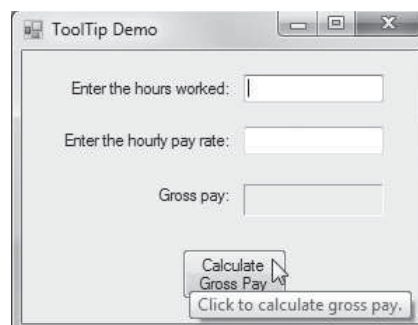
*This page intentionally left blank*

The chapters in this textbook have introduced you to the fundamental Visual C# controls. There are many more controls available in Visual C#, and this appendix introduces you to several of them. The examples discussed in this appendix can be found in the Student Sample Program Files.

## ToolTips

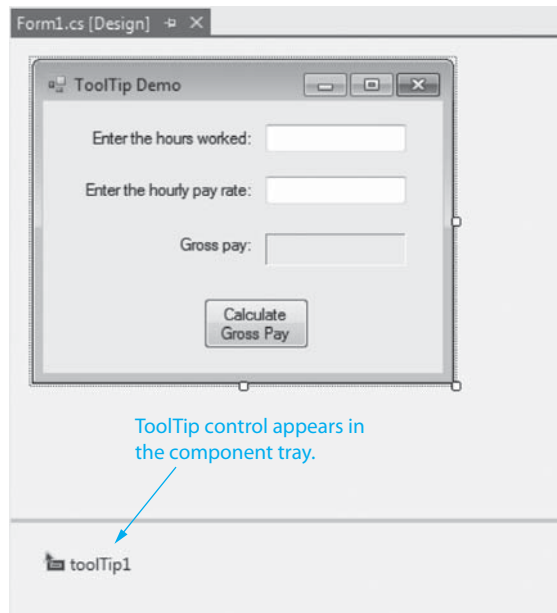
A **ToolTip** is a small box displayed when the user holds the mouse cursor over a control. The box shows a short description of what the control does. Most Windows applications use ToolTips as a way of providing immediate and concise help to the user. Figure B-1 shows an example.

**Figure B-1** A ToolTip displayed



The **ToolTip control** allows you to create ToolTips for other controls on a form. Place a ToolTip control in your application by double-clicking the *ToolTip* icon in the *Toolbox*, just as you place other controls. When you do so, a ToolTip control appears in the component tray, the resizable area at the bottom of the *Designer* that holds invisible controls. Figure B-2 shows an example.



**Figure B-2** ToolTip control

When you add a ToolTip control to a form, a new property is added to all the other controls on that form. The new property is named `ToolTip` on *ToolTipControl*, where *ToolTipControl* is the name of the ToolTip control. For example, suppose you add a ToolTip control to a form and keep the default name `ToolTip1`. The new property added to the other controls is named `ToolTip` on `ToolTip1`.

The `ToolTip` on *ToolTipControl* property holds the string that is displayed as the control's ToolTip. Any text that you enter into a control's `ToolTip` on *ToolTipControl* property is displayed as that control's ToolTip when the user holds the mouse cursor over the control.

### Other ToolTip Properties

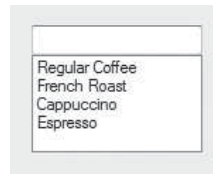
ToolTip controls have other properties that affect their behavior. The `InitialDelay` property determines the amount of time, in milliseconds, that elapses between the user pointing the mouse at a control and the ToolTip's appearance. The default setting is 500. (One millisecond is one-thousandth second, so 500 milliseconds is one-half second.)

The `AutoPopDelay` property is also a measure of time in milliseconds. It determines how long a ToolTip remains on the screen once it is displayed. The default setting is 5000. The `ReshowDelay` property holds the number of milliseconds that elapse between the displaying of different ToolTips as the user moves the mouse from control to control. The default setting is 100.

You can set these properties individually or set them all at once with the `AutomaticDelay` property. When you store a value in the `AutomaticDelay` property, `InitialDelay` is set to the same value, `AutoPopDelay` is set to 10 times the value, and `ReshowDelay` is set to one-fifth the value.

### Combo Boxes

A **combo box** is like a list box that has been combined with a text box. Figure B-3 shows an example of one style of combo box, known as a simple combo box.

**Figure B-3** A simple combo box

Combo boxes and list boxes are similar in the following ways:

- They both display a list of items to the user.
- They both have `Items`, `Items.Count`, `SelectedIndex`, `SelectedItem`, and `Sorted` properties.
- They both have `Items.Add` and `Items.Clear` methods.
- All these properties and methods work the same with combo boxes and list boxes.

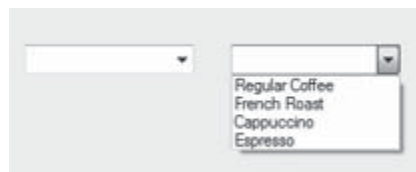
Additionally, a combo box has a rectangular area that works like a text box. The user may either select an item from the combo box's list or type text into the combo box's text input area.

Like a text box, the combo box has a `Text` property. If the user types text into the combo box, the text is stored in the `Text` property. Also, when the user selects an item from the combo box's list, the item is copied to the `Text` property.

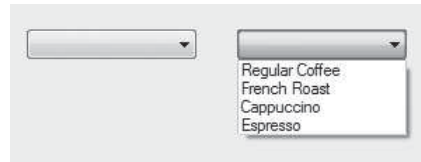
### Combo Box Styles

There are three different styles of combo boxes: the drop-down combo box, the simple combo box, and the drop-down list combo box. You can select a combo box's style with its `DropDownStyle` property. Let's look at the differences of each style.

- **Drop-Down Combo Box.** This is the default setting for the combo box `DropDownStyle` property. At run time, a drop-down combo box like the one shown on the left in Figure B-4 appears. When the user clicks the down arrow, a list drops down as shown in the image on the right in the figure. The user may either select an item from the list or type input into the text box that appears at the top of the control. The item that is selected or the text that is entered is assigned to the combo box's `Text` property.

**Figure B-4** A drop-down combo box

- **Simple Combo Box.** This is the style of combo box shown in Figure B-3. With the simple style of combo box, the list of items does not drop down but is always displayed. As with the drop-down combo box, this style allows the user to select an item from the list or type text directly into the text box area. When typing, the user is not restricted to the items that appear in the list. The item that is selected or the text that is entered is assigned to the combo box's `Text` property.
- **Drop-Down List Combo Box.** With the drop-down list combo box style, the user may not type text directly into the combo box. An item must be selected from the list. At run time, a drop-down list combo box appears, as shown the image on the left in Figure B-5. When the user clicks the down arrow, a list of items appears, as shown in the image on the right in the figure. The item that is selected is assigned to the combo box's `Text` property.

**Figure B-5** A drop-down list combo box

### Getting the User's Input from a Combo Box

As with the list box, you can determine which item has been selected from a combo box's list by retrieving the value in the `SelectedIndex` or `SelectedItem` property. If the user has typed text into the combo box's text area, however, you cannot use the `SelectedIndex` or `SelectedItem` property to get the text. The best way to get the user's input is with the `Text` property, which contains either the user's text input or the item selected from the list.

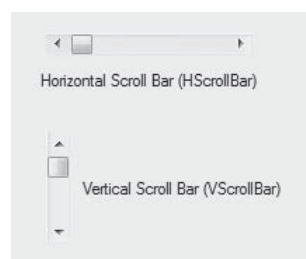
### List Boxes versus Combo Boxes

The following guidelines will help you decide when to use a list box and when to use a combo box.

- Use a drop-down or simple combo box when you want to provide the user a list of items from which to select but do not want to limit the user's input to the items on the list.
- Use a list box or a drop-down list combo box when you want to limit the user's selection to a list of items. The drop-down list combo box generally takes less space than a list box (because the list doesn't appear until the user clicks the down arrow), so use it when you want to conserve space on the form.

## Scroll Bars

**Scroll bars** provide a visual way to adjust a value within a range of values. These types of controls display a slider that may be dragged along a track. Visual C# provides a horizontal scroll bar control named `HScrollBar` and a vertical scroll bar control named `VScrollBar`. Figure B-6 shows examples of each of these controls. You can find these controls in the *Toolbox*, in the *All Windows Forms* group.

**Figure B-6** Horizontal and vertical scroll bars

Here is a summary of the important properties of each of these controls:

- The `Value` property is an integer value that is adjusted as the user moves the control's slider. (The default value is 0.)
- The `Minimum` property is the lower limit of the scrollable range. (The default value is 0.)

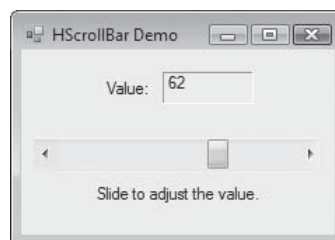
- The `Maximum` property is the upper limit of the scrollable range. (The default value is 100.)
- The `LargeChange` property is the integer amount by which the `Value` property changes when the user clicks the scroll bar area that lies to either side of the slider. This is also the amount by which the `Value` property changes when the user presses the Page Up or Page Down key on the keyboard while the control has the focus. (The default value is 10.)
- The `SmallChange` property is the integer amount by which the `Value` property changes when the user clicks one of the arrows that appear at either end of a scroll bar control. (The default value is 1.)

When a horizontal scroll bar's slider is moved toward its left side, the `Value` property is decreased. When the slider is moved toward the scroll bar's right side, the `Value` property is increased. When a vertical scroll bar's slider is moved toward its top, the `Value` property is decreased. When the slider is moved toward the scroll bar's bottom, the `Value` property is increased.

When the user moves the slider on a scroll bar control, a `Scroll` event occurs. If you write a `Scroll` event handler for the control, the event handler will execute any time the slider is moved. To generate a code template for the `Scroll` event handler, simply double-click the scroll bar control in the *Designer*.

Figure B-7 shows the form in an example application that demonstrates the `HScrollBar` control. The `HScrollBar` control is named `hScrollBar`, and the label that displays the value is named `valueLabel1`. The form's code is shown in Program B-1. This project can be found in the *Appendix B* folder in the Student Sample Programs. You will also find a similar project that demonstrates the `VScrollBar` control.

**Figure B-7** *HScrollBar Demo* application form



**Program B-1** *Form1* code in the *HScrollBar Demo* application

```

1 using System;
2 using System.Collections.Generic;
3 using System.ComponentModel;
4 using System.Data;
5 using System.Drawing;
6 using System.Linq;
7 using System.Text;
8 using System.Threading.Tasks;
9 using System.Windows.Forms;
10
11 namespace HScrollBar_Demo
12 {
13     public partial class Form1 : Form
14     {
15         public Form1()
16         {
17             InitializeComponent();
18         }

```

```

19
20     private void Form1_Load(object sender, EventArgs e)
21     {
22         hScrollBar.Value = 0;
23         hScrollBar.Minimum = 0;
24         hScrollBar.Maximum = 100;
25         hScrollBar.LargeChange = 10;
26         hScrollBar.SmallChange = 1;
27
28         // Display the scroll bar's initial value
29         // in the label control.
30         valueLabel.Text = hScrollBar.Value.ToString();
31     }
32
33     private void hScrollBar_Scroll(object sender, ScrollEventArgs e)
34     {
35         // Display the scroll bar value.
36         valueLabel.Text = hScrollBar.Value.ToString();
37     }
38 }
39 }

```

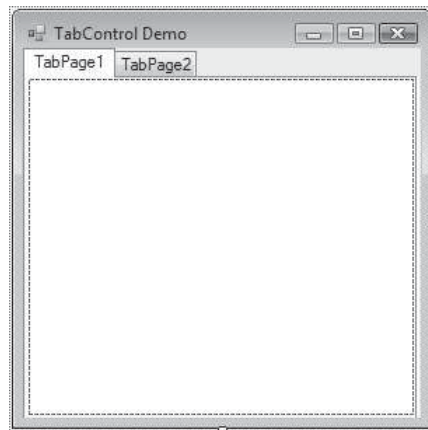
---

## Using a TabControl to Organize a Form


A `TabControl` allows you to create a user interface that is made of multiple pages, with each page containing its own set of controls. The `TabControl` appears as a container on a form, with one or more tabs positioned along its top edge. Each tab represents a different page, known as a `TabPage`. When the user clicks a tab, the control displays that page. You can find the `TabControl` in the *Toolbox*, in the *Containers* group.

When you insert a new `TabControl`, it will contain two `TabPage` controls named `TabPage1` and `TabPage2`. This is shown in Figure B-8. Keep in mind that a `TabControl` is a container that contains `TabPage` controls. When you are working with a `TabControl` in the *Designer*, you can select the `TabControl` (the container) or you can select the individual `TabPage` controls that it contains. When you work with a `TabControl` for the first time, you should practice selecting each of the controls in the group so you know at all times which one you are working with.

**Figure B-8** A `TabControl` with two `TabPage`s



Each of the `TabPage` controls has its own set of properties that can be changed in the *Properties* window. For example, to change the text that is displayed on a `TabPage`'s tab, you change that `TabPage` control's `Text` property.

As previously mentioned, a `TabControl` contains two `TabPage` controls when first inserted in a form. To add more `TabPage`s, select the `TabControl` and then select its `TabPage`s property. (Click the ellipses button  that appears next to the `TabPage`s property window.) This opens the *TabPage Collection Editor*, shown in Figure B-9. This window allows you to add new `TabPage`s, remove existing `TabPage`s, and edit each `TabPage`'s properties.

**Figure B-9** *TabPage Collection Editor* window

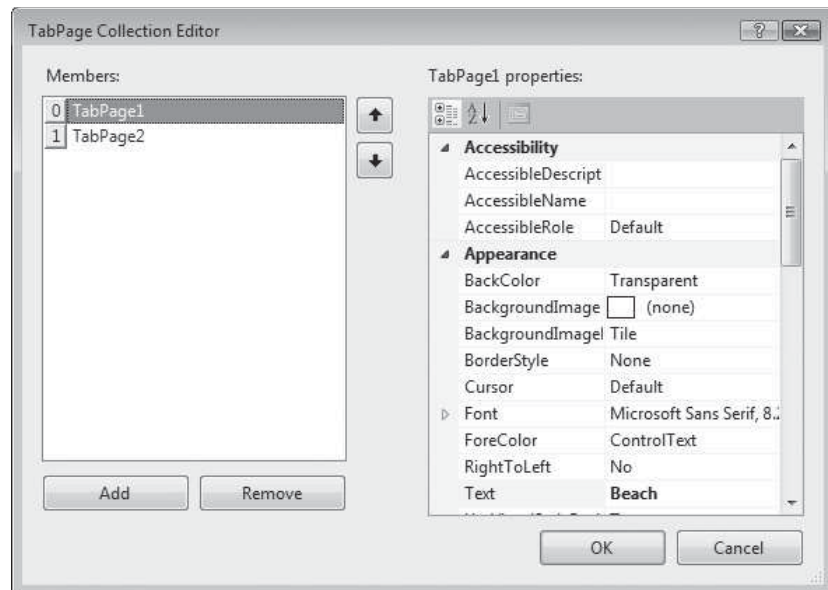


Figure B-10 shows an example application named *TabControl Demo* that can be found in the Student Sample Programs. The application's form has a `TabControl` with three `TabPage`s. Each `TabPage` contains a `PictureBox` control displaying an image. (There is no code in the application.)

**Figure B-10** *TabControl Demo* application



## The WebBrowser Control

The WebBrowser control (found in the *Common Controls* group in the *Toolbox*) allows you to display a Web page on an application's form. The control has a property named `Url` that can be set to a Web page's URL (Uniform Resource Locator). At run time, that Web page is displayed in the control.

At design time, you can use the *Properties* window to set the `Url` property. You simply type a valid URL such as `http://www.gaddisbooks.com` into the property's value box. If you want to set the `Url` property in code, you must create a `Uri` object (Uniform Resource Identifier) and assign that object to the property. Here is an example:

```
WebBrowser1.Url = new Uri("http://www.gaddisbooks.com");
```

Alternatively, you can call the control's `Navigate` method to display a Web page, as shown here:

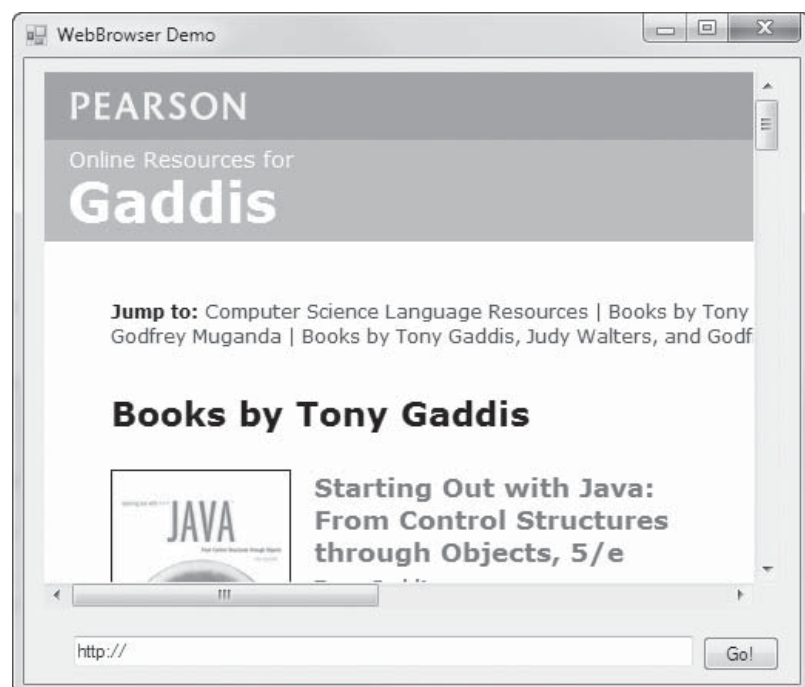
```
WebBrowser1.Navigate(New Uri("http://www.gaddisbooks.com"));
```

In either of these approaches, an exception will be thrown if an invalid Web address is used.

When a Web page has finished loading, a `DocumentCompleted` event occurs. If you want to perform some action after a page has loaded, you can write a handler for this event. (Just double-click the WebBrowser control in the *Designer* window to create a code template for the `DocumentCompleted` event handler.)

Figure B-11 shows the *WebBrowser Demo* application in the Student Sample Programs. The application's form has a WebBrowser control named `webBrowser1`, a `TextBox` control named `urlTextBox`, and a `Button` control named `goButton`. When the user clicks the `goButton` button, the application sets the `webBrowser1` control's `Url` property to the address that has been typed into the `urlTextBox` text box. The `Form1` form's code is shown in Program B-2.

**Figure B-11** *WebBrowser Demo* application



---

**Program B-2** Form1 code in the *WebBrowser Demo* application

---

```
1 using System;
2 using System.Collections.Generic;
3 using System.ComponentModel;
4 using System.Data;
5 using System.Drawing;
6 using System.Linq;
7 using System.Text;
8 using System.Threading.Tasks;
9 using System.Windows.Forms;
10
11 namespace WebBrowser_Demo
12 {
13     public partial class Form1 : Form
14     {
15         public Form1()
16         {
17             InitializeComponent();
18         }
19
20         private void goButton_Click(object sender, EventArgs e)
21         {
22             try
23             {
24                 WebBrowser1.Url = new Uri(urlTextBox.Text);
25             }
26             catch (Exception ex)
27             {
28                 // Error message for an invalid Web address.
29                 MessageBox.Show(ex.Message);
30             }
31         }
32     }
33 }
```

---

## The ErrorProvider Component

The *ErrorProvider* component (found in the *Components* group in the *Toolbox*) allows you to indicate that the user has entered an invalid value by displaying a blinking error icon (❗) next to a specific control on the application's form. When the user hovers the mouse pointer over the icon, an error message is displayed as a *ToolTip*.

When you insert an *ErrorProvider* component, it appears in the component tray at the bottom of the *Designer* window with a default name such as *ErrorProvider1*. In code, when the user enters an invalid value with a specific control, you call the *ErrorProvider* component's *SetError* method. Here is the general format for calling the method:

```
ErrorProviderName.SetError(ControlName, ErrorMessage);
```

In the general format, *ErrorProviderName* is the name of the *ErrorProvider* component, *ControlName* is the name of the control that you want to display the error icon next to, and *ErrorMessage* is the error message to associate with the error. Here is an example:

```
ErrorProvider1.SetError(payRateTextBox, "Invalid pay rate");
```

This statement uses the *ErrorProvider1* component to display an error icon next to the *payRateTextBox* control. When the user hovers the mouse pointer over the error icon, the message *Invalid pay rate* is displayed as a *ToolTip*.

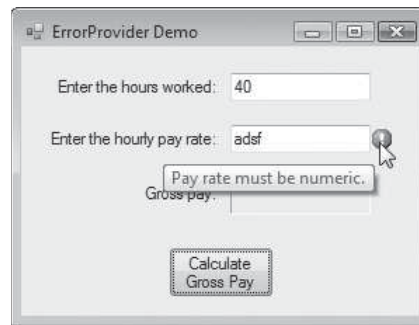


The error icon will remain displayed next to the specified control until you call the `setError` method again, passing the same control name as the first argument and an empty string as the second argument. Here is an example:

```
ErrorProvider1.SetError(payRateTextBox, "");
```

Figure B-12 shows the *ErrorProvider Demo* application in the Student Sample Programs. The user enters a number of hours in the `hoursTextBox` control, a numeric pay rate in the `payRateTextBox` control, and then clicks the `calcButton` control to calculate gross pay. If a nonnumeric value is entered for either the hours or the pay rate, an `ErrorProvider` component displays an error icon next to the control containing the invalid value. In Figure B-12 the user has entered an invalid value for the pay rate. The `Form1` form's code is shown in Program B-3.

**Figure B-12** *ErrorProvider Demo* application



**Program B-3** `Form1` code in the *ErrorProvider Demo* application

```
1 using System;
2 using System.Collections.Generic;
3 using System.ComponentModel;
4 using System.Data;
5 using System.Drawing;
6 using System.Linq;
7 using System.Text;
8 using System.Threading.Tasks;
9 using System.Windows.Forms;
10
11 namespace ErrorProvider_Demo
12 {
13     public partial class Form1 : Form
14     {
15         public Form1()
16         {
17             InitializeComponent();
18         }
19
20         private void calcButton_Click(object sender, EventArgs e)
21         {
22             // Variables for hours, pay rate, and gross pay
23             decimal hours, payRate, grossPay;
24
25             // Clear any existing errors.
26             ErrorProvider1.SetError(hoursTextBox, "");
27             ErrorProvider1.SetError(payRateTextBox, "");
28
29             // Get values and calculate gross pay.
30             if (decimal.TryParse(hoursTextBox.Text, out hours))
```

```
31     {
32         if (decimal.TryParse(payRateTextBox.Text, out payRate))
33         {
34             // Calculate the gross pay.
35             grossPay = hours * payRate;
36
37             // Display the gross pay.
38             grossPayLabel.Text = grossPay.ToString("c");
39         }
40         else
41         {
42             // Invalid pay rate
43             ErrorProvider1.SetError(payRateTextBox,
44                 "Pay rate must be numeric.");
45         }
46     }
47     else
48     {
49         // Invalid hours
50         ErrorProvider1.SetError(hoursTextBox,
51             "Hours must be numeric.");
52     }
53 }
54 }
55 }
```

---

## Using the SelectionStart and SelectionLength Properties to Select Text in a TextBox

TextBox controls have two properties, SelectionStart and SelectionLength, which you can use to make the process of correcting invalid input more convenient for the user. When the user enters an invalid value, you can display an error message and then use these properties to automatically select the invalid input for the user. Then, the user can immediately retype the input without having to use the mouse to select the TextBox.

The SelectionStart and SelectionLength properties can be used in code to automatically select the text in a text box. The SelectionStart property holds the position of the first selected character in the text box. The SelectionLength property holds the number of characters that are selected. For example, assume that nameTextBox is a text box and look at the following code.

```
nameTextBox.Focus();
nameTextBox.SelectionStart = 0;
nameTextBox.SelectionLength = 5;
```

The first statement gives nameTextBox the focus. The second statement establishes that the first character in nameTextBox (which is at position 0) is the first selected character. The next statement establishes that five characters will be selected. Together, the statements cause the first five characters in nameTextBox to be selected.

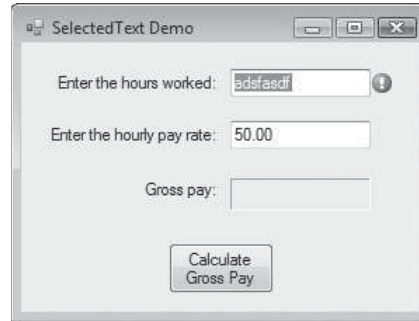
So, how do you use similar code to select all the text in a TextBox? You use the TextBox's Length property to get the length of the text and assign that value to the TextBox's SelectionLength property. Here is an example:

```
nameTextBox.Focus();
nameTextBox.SelectionStart = 0;
nameTextBox.SelectionLength = nameTextBox.Text.Length;
```

After these statements execute, all the contents of the nameTextBox control are selected. When the user types a key, that keystroke immediately erases all the selected text.

Figure B-13 shows the *Selected Text Demo* application in the Student Sample Program files. This is a modified version of the *ErrorProvider Demo* application previously shown. In this version, after the *ErrorProvider* displays an error icon, the content of the *TextBox* containing the invalid input is automatically selected. In the figure, the user has entered an invalid value for the hours. The application's code is shown in Program B-4.

**Figure B-13** *Selected Text Demo* application



**Program B-4** Form1 code in the *Selected Text Demo* application

```

1 using System;
2 using System.Collections.Generic;
3 using System.ComponentModel;
4 using System.Data;
5 using System.Drawing;
6 using System.Linq;
7 using System.Text;
8 using System.Threading.Tasks;
9 using System.Windows.Forms;
10
11 namespace Selected_Text_Demo
12 {
13     public partial class Form1 : Form
14     {
15         public Form1()
16         {
17             InitializeComponent();
18         }
19
20         private void calcButton_Click(object sender, EventArgs e)
21         {
22             // Variables for hours, pay rate, and gross pay
23             decimal hours, payRate, grossPay;
24
25             // Clear any existing errors.
26             ErrorProvider1.SetError(hoursTextBox, "");
27             ErrorProvider1.SetError(payRateTextBox, "");
28
29             // Get values and calculate gross pay.
30             if (decimal.TryParse(hoursTextBox.Text, out hours))
31             {
32                 if (decimal.TryParse(payRateTextBox.Text, out payRate))
33                 {
34                     // Calculate the gross pay.
35                     grossPay = hours * payRate;
36
37                     // Display the gross pay.

```

```

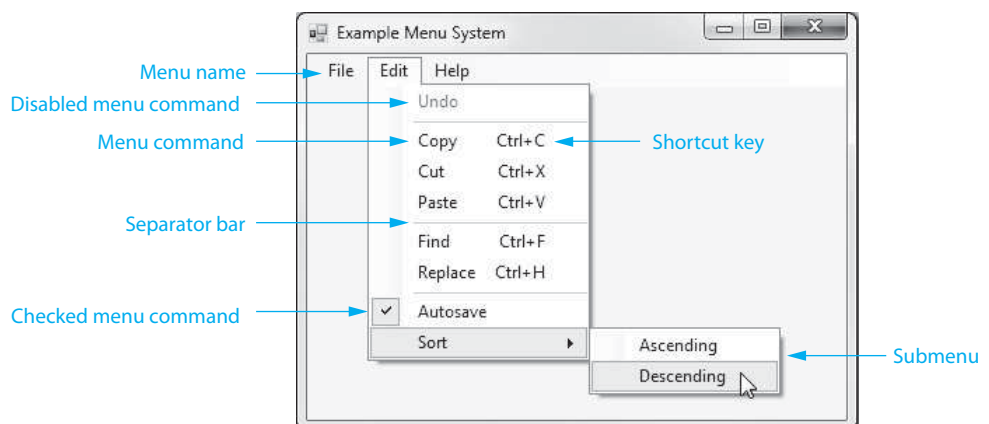
38         grossPayLabel.Text = grossPay.ToString("c");
39     }
40     else
41     {
42         // Invalid pay rate
43         ErrorProvider1.SetError(payRateTextBox,
44             "Pay rate must be numeric.");
45
46         // Select the invalid input.
47         payRateTextBox.Focus();
48         payRateTextBox.SelectionStart = 0;
49         payRateTextBox.SelectionLength =
50             payRateTextBox.Text.Length;
51     }
52 }
53 else
54 {
55     // Invalid hours
56     ErrorProvider1.SetError(hoursTextBox,
57         "Hours must be numeric.");
58
59     // Select the invalid input.
60     hoursTextBox.Focus();
61     hoursTextBox.SelectionStart = 0;
62     hoursTextBox.SelectionLength =
63         hoursTextBox.Text.Length;
64 }
65 }
66 }
67 }

```

## Creating a Menu System

A **menu system** is a collection of commands organized in one or more drop-down menus. In Visual Studio, the **menu designer** allows you to visually create a custom menu system for any form in an application. Before you learn how to use the menu designer, you must learn about the typical components of a menu system. Look at the Example Menu System shown in Figure B-14.

**Figure B-14** Example Menu System



The menu system in the figure consists of the following items.

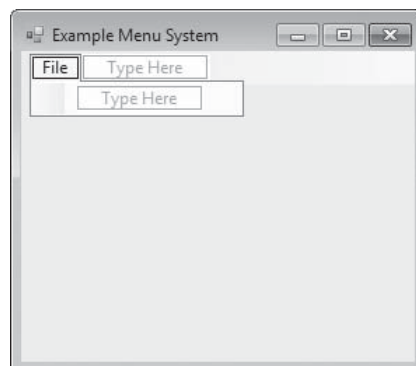
- **Menu names.** Each drop-down menu has a name. The menu names are listed on a menu strip that appears just below the form's title bar. The menu names in Figure B-14 are *File*, *Edit*, and *Help*. The user may activate a menu by clicking the menu name. In the figure, the *Edit* menu has been activated.
- **Menu command.** Menus have commands. The user selects a command by clicking it, entering its access key, or entering its shortcut key.
- **Shortcut key.** A shortcut key is a key or combination of keys that cause a menu command to execute. Shortcut keys are shown on a menu to the right of their corresponding commands. For example, in Figure B-14, Ctrl+C is the shortcut key for the *Copy* command.
- **Disabled menu command.** You can cause a menu command to be disabled when you do not want the user to select it. A disabled menu command appears in dim lettering (grayed out) and cannot be selected. In Figure B-14, the *Undo* command is disabled.
- **Checked menu command.** A checked menu command is usually one that turns an option on or off. A checkmark appears to the left of the command, indicating the option is turned on. When no checkmark appears to the left of the command, the option is turned off. The user toggles a checked menu command each time he or she selects it. In Figure B-14, *Autosave* is a checked menu command.
- **Submenu.** Some of the commands on a menu are actually the names of submenus. You can tell when a command is the name of a submenu because a right arrow appears to its right. Activating the name of a submenu causes the submenu to appear. For example, in Figure B-14, clicking the *Sort* command causes a submenu to appear.
- **Separator bar.** A separator bar is a horizontal bar used to separate groups of commands on a menu. In Figure B-14, separator bars are used to separate the *Copy*, *Cut*, and *Paste* commands into one group, the *Find* and *Replace* commands into another group, and the *Sort* command in a box by itself. Separator bars are used only as visual aids and cannot be selected by the user.

### The MenuStrip Control

An application's menu system is constructed with a **MenuStrip control**. When your form is displayed in the *Designer*, find the *Menus & Toolbars* section of the *Toolbox* window and double-click the *MenuStrip* icon. A *MenuStrip* control will appear in the component tray at the bottom of the *Designer*, with a default name of *MenuStrip1*.

When the *MenuStrip* control is selected, you will see the words *Type Here* displayed in a strip at the top of the form. This is the **menu designer**, a tool that allows you to visually edit the contents of the menu. You simply click inside this strip and type the names of the items that you want to appear in the menu. Figure B-15 shows an example where a *File* menu has been added.

**Figure B-15** Inserting text into a menu item



Each item that you create in a menu system is a **ToolStripMenuItem** object. When you select a menu item in the menu designer, you see its properties listed in the *Properties* window. The text that you typed for the item in the menu designer will appear in the object's Text property.

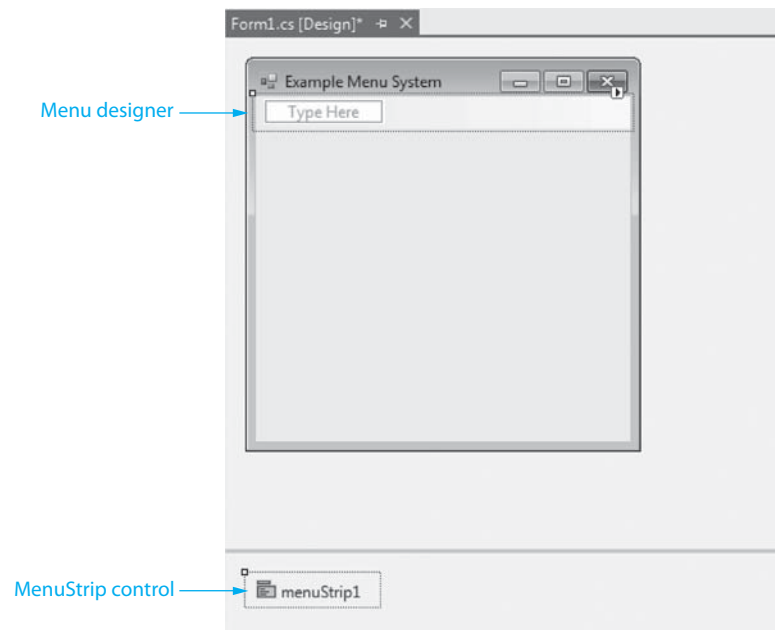
ToolStripMenuItem objects are given default names that are based on the text that you typed for the object in the menu designer. For example, if you type the text “File” for a menu item, the object's name will be `fileToolStripMenuItem`. For another example, if you type the text “Help” for a menu item, the object's name will be `helpToolStripMenuItem`.

ToolStripMenuItem objects also respond to events. You can make a menu functional by writing Click event procedures for its objects.

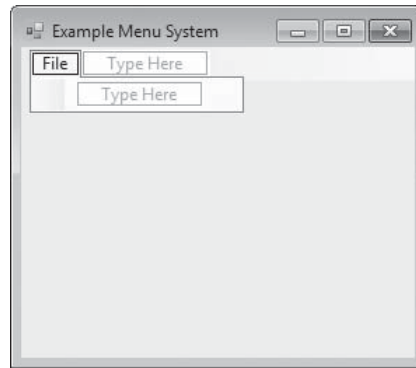
### How to Use the Menu Designer

Once you have placed a MenuStrip control in a form's component tray, you can use the menu designer to create menu items. Start the menu designer by selecting the MenuStrip control. Figure B-16 shows a form with a MenuStrip control selected in the component tray, and the menu designer started. The menu designer appears on the form in the location that the menu system will appear.

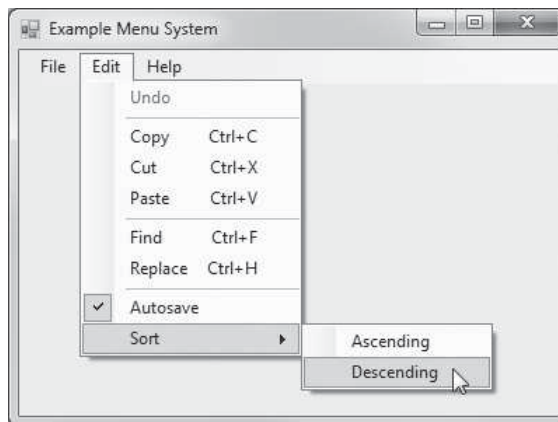
**Figure B-16** MenuStrip control selected and menu designer started



Notice in Figure B-16 that the words *Type Here* appear in a small box in the menu designer. This marks the position of the first menu item. A ToolStripMenuItem object is automatically created when you type text into the box. The text you type is stored in the item's Text property and is displayed on the menu strip. Figure B-17 shows the menu designer after the word *File* has been typed as the text for the first menu item.

**Figure B-17** MenuStrip object with *File* as its text

Notice that the menu designer now shows two new *Type Here* boxes, one below and one to the right of the first object. Simply click in one of the boxes to select it and then type the text that you wish to appear at that position. Figure B-18 shows the menu designer with a more complete menu system. The menu system has *File*, *Edit*, and *Help* menus. The *Edit* menu is displayed.

**Figure B-18** Menu designer with many items

### Shortcut Keys

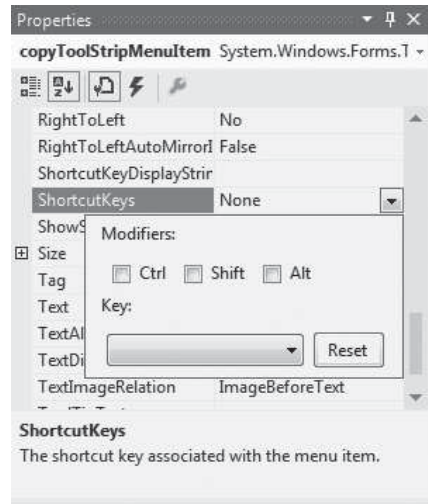
As previously stated, a shortcut key is a key or combination of keys that cause a menu command to execute. Table B-1 lists some commonly used shortcut keys in Windows applications.

**Table B-1** Some commonly used shortcut keys in Windows applications

Shortcut Key	Command
Ctrl+S	Save
Ctrl+P	Print
Ctrl+C	Copy
Ctrl+X	Cut
Ctrl+V	Paste

Shortcut keys are shown on a menu to the right of their corresponding commands. To create a shortcut key for a menu item, click the down arrow that appears next to the **ShortcutKeys** property in the *Properties* window. A dialog appears, as shown in Figure B-19. The *Key* drop-down list shows all the available shortcut keys and allows you to select a key from the list. The dialog also allows you to select the **Ctrl**, **Shift**, or **Alt** key (or any combination of these). For example, if you want to assign **Ctrl+S** as a shortcut key, you would select the *S* key in the drop-down list and place a check next to *Ctrl*.

**Figure B-19** The **ShortcutKeys** property



You must also make sure that the **ShowShortcut** property is set to *True*. When set to *False*, the item's shortcut key is not displayed.

### Checked Menu Items

Some programs have menu items that simply turn a feature on or off. For example, suppose you are creating an application that functions as an alarm clock and you want the user to be able to turn the alarm on or off with a menu item. A common approach would be to have a checked menu item for the alarm. When a checkmark appears next to the menu item, it indicates that the alarm is on. When the checkmark is not displayed next to the menu item, it indicates that the alarm is off. When the user clicks the menu item, it toggles its state between on and off. This type of menu item is called a checked menu item.

To give a menu item the ability to become checked or unchecked when it is clicked by the user, you set the item's **CheckOnClick** property to *True*. You can then set the **Checked** property to either *True* or *False* to specify how the item should initially appear when the application runs. If you set the **Checked** property to *True*, the item will appear with a checkmark next to it. If you set the **Checked** property to *False*, no checkmark will be shown.

In code you can use the **Checked** property to determine whether a menu item is checked. If the **Checked** property is set to *True*, it means the item is checked. If the **Checked** property is set to *False*, it means the item is unchecked. The following code shows an example.



This code tests the `Checked` property of a menu item named `alarmToolStripMenuItem`. If the item is checked, a message box is displayed.

```
if (alarmToolStripMenuItem.Checked)
{
    MessageBox.Show("WAKE UP!");
}
```

### Disabled Menu Items

A disabled menu item appears dimmed, or grayed out, and may not be selected by the user. You may disable a menu item by setting its `Enabled` property to `False`. For example, applications that provide *Cut*, *Copy*, and *Paste* commands usually disable the *Paste* command until something is cut or copied. So, the *Paste* menu item's `Enabled` property can be set to `False` at design time (in the *Properties* window) and then set to `true` in code after the *Cut* or *Copy* command has been used. Assuming that the *Paste* menu item is named `pasteToolStripMenuItem`, the following code enables it:

```
pasteToolStripMenuItem.Enabled = true;
```

### Separator Bars

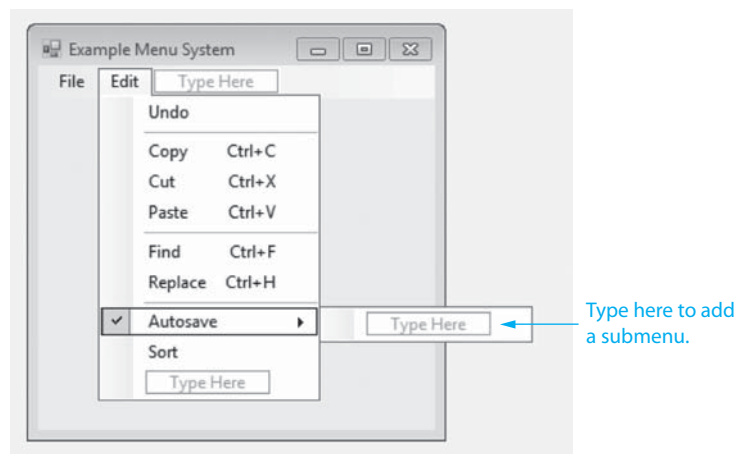
You can insert a separator bar into a menu in either of the following ways:

- Right-click an existing menu item. On the pop-up menu that appears, select *Insert* and then select *Separator*. A separator bar is inserted above the menu item.
- Type a hyphen (-) as a menu item's `Text` property.

### Submenus

When an existing menu item is selected in the menu designer, a *Type Here* box is displayed to its right. Figure B-20 shows an example. This box allows you to create a submenu item. When you create a submenu, a right arrow (▶) is automatically displayed next to the menu item that is the parent of the submenu.

**Figure B-20** Creating a submenu



### Inserting Menu Items in an Existing Menu

If you need to insert a new menu item above an existing menu item, start the menu designer and then right-click the existing menu item. On the pop-up menu that appears, select *Insert* and then select *MenuItem*. A new menu item is inserted above the existing

menu item. If you need to insert a new menu item at the bottom of an existing menu, start the menu designer and simply select the desired menu or submenu. A *Type Here* box automatically appears at the bottom.

### Deleting Menu Items

To delete a menu item, start the menu designer and perform one of the following procedures:

- Right-click the menu item you wish to delete. On the pop-up menu, select *Delete*.
- Select the menu item you wish to delete and then press `[Delete]` on the keyboard.

### Rearranging Menu Items

You can move a menu item by clicking and dragging. Simply select it in the menu designer and drag it to the desired location.

### ToolStripMenuItem Click Events

You do not have to write code to display a menu or a submenu. When the user clicks a menu item that displays a menu or a submenu, Visual Studio automatically causes the menu or submenu to appear.

If a menu item does not have a menu or submenu to display, you make it functional by providing a Click event handler for it. For example, assume a menu system has a *File* menu with an *Exit* command, which causes the application to end. The menu item for the *Exit* command is named `exitToolStripMenuItem`. Here is the code for the object's Click event handler:

```
private void exitToolStripMenuItem_Click(object sender, EventArgs e)
{
    // Close the form.
    this.Close();
}
```

To write a Click event handler for a menu item, start the menu designer and then double-click the desired menu item. An empty event handler is created.

### Standard Menu Items

Although not all applications have identical menu systems, it is standard for most applications to have the following menu items:

- A *File* menu as the leftmost item on the menu strip.
- An *Exit* command on the *File* menu. This command ends the application.
- A *Help* menu as the rightmost item on the menu strip.
- An *About* command on the *Help* menu. This command displays a window giving basic information about the application.

You should always add these items to your menu systems because most Windows users expect to see them. You should also assign shortcut keys to the most commonly used commands. Study the menu system in an application such as Microsoft Word or Microsoft Excel to become familiar with a typical menu design.

*This page intentionally left blank*



## ASCII/Unicode Characters

The following table lists the ASCII (American Standard Code for Information Interchange) character set, which is the same as the first 127 Unicode character codes. This group of character codes is known as the *Latin Subset of Unicode*. The code columns show character codes and the character columns show the corresponding characters. For example, the code 65 represents the letter A. Note that the first 31 codes, and code 127, represent control characters that are not printable.

Code	Character	Code	Character	Code	Character	Code	Character	Code	Character
0	NUL	26	SUB	52	4	78	N	104	h
1	SOH	27	Escape	53	5	79	O	105	i
2	STX	28	FS	54	6	80	P	106	j
3	ETX	29	GS	55	7	81	Q	107	k
4	EOT	30	RS	56	8	82	R	108	l
5	ENQ	31	US	57	9	83	S	109	m
6	ACK	32	(Space)	58	:	84	T	110	n
7	BEL	33	!	59	;	85	U	111	o
8	Backspace	34	"	60	<	86	V	112	p
9	HTab	35	#	61	=	87	W	113	q
10	LineFeed	36	\$	62	>	88	X	114	r
11	VTab	37	%	63	?	89	Y	115	s
12	FormFeed	38	&	64	@	90	Z	116	t
13	CR	39	'	65	A	91	[	117	u
14	SO	40	(	66	B	92	\	118	v
15	SI	41	)	67	C	93	]	119	w
16	DLE	42	*	68	D	94	^	120	x
17	DC1	43	+	69	E	95	_	121	y
18	DC2	44	,	70	F	96	'	122	z
19	DC3	45	-	71	G	97	a	123	{
20	DC4	46	.	72	H	98	b	124	
21	NAK	47	/	73	I	99	c	125	}
22	SYN	48	0	74	J	100	d	126	~
23	ETB	49	1	75	K	101	e	127	DEL
24	CAN	50	2	76	L	102	f		
25	EM	51	3	77	M	103	g		

## Chapter 1

- 1.1 A program is a set of instructions that a computer follows to perform a task.
- 1.2 Hardware is all the physical devices, or components, that a computer is made of.
- 1.3 The central processing unit (CPU), main memory, secondary storage devices, input devices, and output devices
- 1.4 The CPU
- 1.5 Main memory
- 1.6 Secondary storage
- 1.7 Input device
- 1.8 Output device
- 1.9 Operating system
- 1.10 Utility program
- 1.11 Application software
- 1.12 1 byte
- 1.13 A bit
- 1.14 Binary
- 1.15 It is an encoding scheme that uses a set of 128 numeric codes to represent the English letters, various punctuation marks, and other characters. These numeric codes are used to store characters in a computer's memory. (ASCII stands for the American Standard Code for Information Interchange.)
- 1.16 Unicode
- 1.17 Digital data is data that is stored in binary, and a digital device is any device that works with binary data.

- 1.18 Machine language
- 1.19 Main memory, or RAM
- 1.20 The fetch-decode-execute cycle
- 1.21 It is an alternative to machine language. Instead of using binary numbers for instructions, assembly language uses short words that are known as mnemonics.
- 1.22 A high-level language
- 1.23 Syntax
- 1.24 A compiler
- 1.25 An interpreter
- 1.26 A syntax error
- 1.27 The part of the computer with which the user interacts
- 1.28 A command line interface requires the user to type commands. If a command is typed correctly, it is executed and the results are displayed. If a command is not typed correctly, an error message is displayed.
- 1.29 The program
- 1.30 A program that responds to events that are caused by the user, such as the clicking of a mouse
- 1.31 A program component that contains data and performs operations
- 1.32 Object oriented
- 1.33 An object can (1) store data in fields or properties and (2) perform operations called methods.
- 1.34 Controls
- 1.35 To perform some task
- 1.36 Code that describes a particular type of object
- 1.37 A collection of classes and other code that can be used, along with a programming language such as C#, to create programs for the Windows operating system
- 1.38 When a program needs specific objects that cannot be found in the .NET framework
- 1.39
  1. *Understand the program's purpose*
  2. *Design the graphical user interface (GUI)*
  3. *Design the program's logic*
  4. *Write the code*
  5. *Correct syntax errors*
  6. *Test the program and correct logic errors*
- 1.40 A set of well-defined logical steps that must be taken to perform a task
- 1.41 An algorithm that is written out in this manner, in plain English statements
- 1.42 A diagram that graphically depicts the steps of an algorithm
- 1.43
  - Oval—terminal symbol
  - Parallelogram—input or output
  - Rectangle—processing

- 1.44 The *Solution Explorer* window allows you to navigate among the files in a Visual C# project.
- 1.45 When you are creating a Visual C# application, you use the *Properties* window to examine and change a control's properties.
- 1.46 The standard toolbar contains buttons that execute frequently used commands.
- 1.47 The *Toolbox* is a window that allows you to select the controls that you want to use in an application's user interface. The toolbar contains buttons that execute frequently used Visual Studio commands.
- 1.48 A small rectangular box that pops up when you hover the mouse pointer over a button on the toolbar or in the *Toolbox* for a few seconds
- 1.49 A Visual C# project consists of several files. You can think of a project as a collection of files that belong to a single application.
- 1.50 A solution is a container that holds one or more Visual C# projects. If you are developing applications for a large organization, you might find it convenient to store several related projects together in the same solution.

## Chapter 2

- 2.1 An empty form in the *Designer*
- 2.2 It is enclosed by a thin dotted line called a bounding box.
- 2.3 To resize an object's bounding box using the mouse
- 2.4 A name
- 2.5 To display the properties of the currently selected object
- 2.6 Causes the properties to be displayed in alphabetical order
- 2.7 Causes the properties to be displayed in groups
- 2.8 The text that is displayed in the form's title bar
- 2.9 The form's width and height in pixels
- 2.10 A scrollable list of controls that you can add to a form
- 2.11 To add a control to a form, you simply find it in the *Toolbox* and then double-click it.
- 2.12 What the button will do when it is clicked
- 2.13 The first character must be one of the letters *a-z* or *A-Z* or an underscore character. After the first character, you may use the letters *a-z* or *A-Z*, the digits 0-9, or underscores. The name cannot contain spaces.
- 2.14 The camelCase naming convention
- 2.15 Source code
- 2.16 If you want your application to perform any meaningful actions you must write code.
- 2.17 The application's start-up code
- 2.18 Code that is associated with the Form1 form



- 2.19 Namespaces, classes, and methods
- 2.20 A container that holds classes
- 2.21 Braces ( { } )
- 2.22 Click the tab for the desired window.
- 2.23 Double-click the button control in the *Designer*.
- 2.24 An event that occurs when an application is running and the user clicks a control
- 2.25 `MessageBox.Show`
- 2.26 Data that is literally written into a program
- 2.27 Double quotation marks
- 2.28 Press the F5 key on the keyboard, or click the *Start Debugging* button on the toolbar.
- 2.29 The *Common Controls* group
- 2.30 The Text property
- 2.31 The Font property
- 2.32 None
- 2.33 Click the down-arrow button that appears next to the property's value. Select the desired value from the list.
- 2.34 The AutoSize property
- 2.35 The TextAlign property
- 2.36 Place a Label control on the form at the location where you want the result to be displayed. Erase the contents of the Label control's Text property. In the application's code, you write the necessary statements to perform the calculation and then you store the result of the calculation in the Label control's Text property.
- 2.37 It clears the text that is displayed in a Label control.
- 2.38 To display a graphic image on a form
- 2.39 In the *Common Controls* group
- 2.40 Use its Image property to specify the image that it will display.
- 2.41 Normal
- 2.42 The image is uniformly resized to fit in the PictureBox without losing its original aspect ratio.
- 2.43 Create a Click event handler for the PictureBox control that displays the image.
- 2.44 Yes, if a control's Visible property is set to False, the control can still be seen at design time, but during run time, the control will not be visible.
- 2.45 Comments are brief notes that are placed in a program's source code to explain how parts of the program work.
- 2.46 A Line comment begins with two forward slashes and appears on one line. A Block comment starts with a forward slash and an asterisk and ends with an asterisk followed by a forward slash and can occupy multiple lines.

- 2.47 Be careful not to reverse the beginning and ending symbols, and don't forget the ending symbol.
- 2.48 Programmers commonly use blank lines and indentations in their code to create a sense of visual organization; this makes the code easier to understand and to read.
- 2.49 `this.Close();`
- 2.50 It is underlined with a jagged line in the code editor.
- 2.51 A description of the error will pop up in a *ToolTip* window.
- 2.52 A window appears that displays the errors.

## Chapter 3

- 3.1 A TextBox control
- 3.2 Retrieve the contents of the control's Text property
- 3.3 A string
- 3.4 Assign an empty string (" ") to the Text property.
- 3.5 To store a value in memory
- 3.6 `string myFavoriteFood = "pizza";`
- 3.7
  - a. String
  - b. Real number
  - c. String
  - d. Integer
- 3.8
  - a. Legal
  - b. Illegal; spaces are not allowed in variable names.
  - c. Legal
  - d. Illegal; first character of the variable name cannot be a number.
- 3.9 The string "Hello!"
- 3.10 While the event is executing; then it is deleted.
- 3.11 The statement will result in an error.
- 3.12 Yes, string variables can be assigned only string values.
- 3.13 `string name, city, state;`
- 3.14
  - a. decimal
  - b. int
  - c. double
  - d. decimal
  - e. int
- 3.15 b, variables of the int data type can be assigned only whole-number values.
- 3.16 `int dollars = (int)deposit;`
- 3.17 6
- 3.18 length and width
- 3.19
  - 1. Perform any operations that are enclosed in parentheses.
  - 2. Perform any multiplications, divisions, or modulus operations as they appear from left to right
  - 3. Perform any additions or subtractions as they appear from left to right.

- 3.20 `decimal pricePerFoot = 2.99m;`  
`decimal boardLength = 10.5;`  
`decimal totalCost = boardLength * pricePerFoot;`  
 or  
`decimal pricePerFoot = 2.99m;`  
`double boardLength = 10.5;`  
`decimal totalCost = (decimal)boardLength * pricePerFoot;`
- 3.21 9
- 3.22 70
- 3.23 2.5
- 3.24 a. `count += 1;`  
 b. `amount -= 5;`  
 c. `radius *= 10;`  
 d. `length /= 2;`
- 3.25 `int.Parse`
- 3.26 a. `decimal.Parse("90.5");`  
 b. `decimal.Parse(grandTotal);`  
 c. `decimal.Parse("50");`  
 d. `decimal.Parse(priceTextBox.Text);`
- 3.27 The result will be an error because numeric values cannot be assigned to strings.
- 3.28 a. `MessageBox.Show(grandTotal.ToString());`  
 b. `MessageBox.Show(highScore.ToString());`  
 c. `MessageBox.Show(sum.ToString());`  
 d. `MessageBox.Show(width.ToString());`
- 3.29 `resultLabel.Text = result.ToString();`
- 3.30 `MessageBox.Show(salary.ToString("c"));`
- 3.31 a. "P" or "p" for percent format  
 b. "E" or "e" for exponential scientific format  
 c. "C" or "c" for currency format  
 d. "N" or "n" for number format  
 e. "F" or "f" for fixed-point scientific format
- 3.32 12
- 3.33 `"d5"`
- 3.34 `millimeters.ToString("f4");`
- 3.35 An unexpected error that occurs while a program is running, such as user input that is not in the correct format
- 3.36 Click the *Stop Debugging* button or by pressing `[Shift] + [F5]`.
- 3.37 Statements that can potentially throw an exception
- 3.38 If a statement in the try block throws an exception
- 3.39 Assign a name to the exception object when writing the catch clause of a try-catch statement and then use the Message property of the exception object in the catch block to display the default error message in a message box.

```

3.40 try
    {
        int value1;    // To hold value 1.
        int value2;    // To hold value 2.
        int sum;       // To hold the sum.

        // Get the values as input from the user.
        value1 = int.Parse(value1TextBox.Text);
        value2 = int.Parse(value2TextBox.Text);

        // Calculate the sum of value 1 and value 2.
        sum = value1 + value2;

        // Display the result in the Label control.
        sumLabel.Text = sum.ToString();
    }
    catch (Exception ex)
    {
        // Display the default error message.
        MessageBox.Show(ex.Message);
    }
}

```

3.41 They make programs more self-explanatory and allow for widespread changes to easily be made to the program.

3.42 `const double DISCOUNT = 0.9;`

3.43 At the top of a class declaration, before any methods

3.44 It's a good programming practice to make fields `private` because `private` fields are hidden from code outside the class. That prevents code outside the class from changing the values of a class's fields and helps prevent bugs from creeping into your program.

3.45 A local variable exists only while the method in which it is declared is executing, but a field exists as long as the form exists.

3.46 `private const decimal INTEREST_RATE = 0.059m;`

3.47 `double product = Math.Pow(12.0, 2.0);`

3.48 `Math.Max`

3.49 `Math.Min`

3.50 The button's Click event handler will execute.

3.51 Click *View* on the Visual Studio menu bar and then click *Tab Order*. Exit tab order selection mode by pressing the Esc key.

3.52 `numberTextBox.Focus();`

3.53 In the Text property, place an ampersand (&) before the character you wish to use as the access key.

3.54 In the Text property, place two ampersand (&&) characters where you would like the single ampersand to appear on the Button control.

3.55 `resultLabel.BackColor = Color.White;`  
`resultLabel.ForeColor = Color.Red;`

3.56 None, Tile, Center, Stretch, and Zoom

3.57 The controls inside the GroupBox control are also deleted.

3.58 The TabIndex values of controls inside a group box are organized relative to the GroupBox control's TabIndex property.

- 3.59 A Panel cannot display a title and does not have a Text property. A Panel's border can be specified by its BorderStyle property.

## Chapter 4

- 4.1 A logical design that controls the order in which a set of statements execute
- 4.2 It is a program structure that can execute a set of statements only under certain circumstances.
- 4.3 A decision structure that provides a single alternative path of execution. If the condition that is being tested is true, the program takes the alternative path.
- 4.4 An expression that can be evaluated as either true or false
- 4.5 You can determine whether one value is greater than, less than, greater than or equal to, less than or equal to, equal to, or not equal to another value.
- 4.6 

```
if (y == 20)
{
    x = 0;
}
```
- 4.7 

```
if (sales >= 10000)
{
    commissionRate = 0.2;
}
```
- 4.8 A dual alternative decision structure has two possible paths of execution—one path is taken if a condition is true and the other path is taken if the condition is false.
- 4.9 When the Boolean expression is false
- 4.10 

```
if (sales >= 50000)
{
    commissionRate = 0.2;
}
else
{
    commissionRate = 0.1;
}
```
- 4.11 

```
if (number == 1)
{
    MessageBox.Show("One");
}
else if (number == 2)
{
    MessageBox.Show("Two");
}
else if (number == 3)
{
    MessageBox.Show("Three");
}
else
{
    MessageBox.Show("Unknown");
}
```
- 4.12 It is an expression that is created by using a logical operator to combine two Boolean subexpressions.

4.13 F; T; F; F; T; T; T; F; F; T

4.14 T; F; T; T; T

4.15 The `&&` operator: If the expression on the left side of the `&&` operator is false, the expression on the right side will not be checked.

The `||` operator: If the expression on the left side of the `||` operator is true, the expression on the right side will not be checked.

```
4.16 if (speed >= 0 && speed <= 200)
    {
        MessageBox.Show("The number is valid");
    }
```

```
4.17 if (speed < 0 || speed > 200)
    {
        MessageBox.Show("The number is not valid");
    }
```

4.18 true or false

4.19 A variable that signals when some condition exists in the program

4.20 z is not less than a.

4.21 Boston; New York

4.22 true

4.23 The variable specified by the second argument

4.24 0

4.25 It specifies an output variable. An output variable is a variable that is passed as an argument to a method, and when the method is finished, a value is stored in the variable.

4.26 Only one

4.27 All of them can potentially be selected.

4.28 When a `CheckBox` or `RadioButton` control is selected, or checked, its `Checked` property is set to `True`.

```
4.29 switch (choice)
    {
        case 1:
            MessageBox.Show("You chose 1.");
            break;
        case 2:
            MessageBox.Show("You chose 2.");
            break;
        case 3:
            MessageBox.Show("You chose 3.");
            break;
        default:
            MessageBox.Show("Make another choice.");
            break;
    }
```

4.30 You select the `Items` property and then use the *String Collection Editor* to enter items.

- 4.31. When the user selects an item in a `ListBox`, the item is stored in the `ListBox`'s `SelectedItem` property.
- 4.32. When the user selects an item in a `ListBox`, the item's index is stored in the `ListBox`'s `SelectedIndex` property. If no item is selected in the `ListBox`, the `SelectedIndex` property is set to `-1`.

## Chapter 5

- 5.1 You call the control's `Items.Add` method.
- 5.2 The control's `Items.Count` property holds the number of items stored in the `ListBox`.
- 5.3 You call the control's `Items.Clear` method.
- 5.4 An execution of the statements in the body of the loop
- 5.5 A variable that is used to store the number of iterations that a loop has performed
- 5.6 A loop that tests its Boolean expression before performing an iteration
- 5.7 Before
- 5.8 A loop that has no way of stopping and repeats until the program is interrupted
- 5.9 6; 5
- 5.10 Four times
- 5.11 Initialization, test, and update
- 5.12 Here is one possible set of answers:
- ```
a. count = 0;
b. count < 50;
c. count++
d. for (count = 0; count < 50; count++)
    {
        MessageBox.Show("I love to program");
    }
```
- Here is another possible set of answers:
- ```
a. count = 1;
b. count <= 50;
c. count++
d. for (count = 1; count <= 50; count++)
    {
        MessageBox.Show("I love to program");
    }
```
- 5.13 It would display the numbers 1, 2, 3, 4, and 5 in message boxes.
- 5.14 It would display the numbers 0, 100, 200, 300, 400, and 500 in message boxes.
- 5.15 A loop that tests its Boolean expression after it performs an iteration
- 5.16 The `while` loop is a pretest loop, and the `do-while` loop is a posttest loop. The `do-while` loop will always iterate at least one time.
- 5.17 One time
- 5.18 A file that data is written to. It is called an output file because the program stores output in it.
- 5.19 A file from which data is read; it is called an input file because the program gets input from the file.

- 5.20 Open the file, process the file, and close the file.
- 5.21 A text file contains data that has been encoded as text, using a scheme such as Unicode. A binary file contains data that has not been converted to text.
- 5.22 Sequential and direct (or random) access. When you work with a sequential access file, you access data from the beginning of the file to the end of the file. When you work with a direct access file, you can jump directly to any piece of data in the file without reading the data that comes before it.
- 5.23 `StreamWriter`
- 5.24 `StreamReader`
- 5.25 Its contents are erased.
- 5.26 Its contents are not erased.
- 5.27 The `writeLine` method writes an item of data to a file and then writes a newline character. The `write` method writes an item of data to a text file without writing a newline character.
- 5.28 `File.OpenText`
- 5.29 A file's read position marks the location of the next item that will be read from the file. When an input file is opened, its read position is initially set to the first item in the file.
- 5.30 With the `StreamReader` class's `ReadLine` method
- 5.31 With the `StreamReader` or `StreamWriter` class's `Close` method
- 5.32 Loop B is written in the correct form.
- 5.33 Most users of Windows are accustomed to using a dialog box to browse their disk for a file to open or for a location to save a file. An *Open* and/or *Save As* dialog box allows the user of your application to easily specify a file's name and location.
- 5.34 *InitialDirectory*: Specifies the directory to be initially displayed  
*Title*: Specifies the text displayed in the title bar  
*Filename*: When the user selects a file with the *Open* dialog box, the file's path and filename are stored in the control's `Filename` property. When the user specifies a location and filename with the *Save As* dialog box, the file's path and filename are stored in the control's `Filename` property.
- 5.35 If you call the `Next` method with no arguments, the method returns an integer that is somewhere between 0 and 2,147,483,647. Alternatively, you can pass an argument that specifies an upper limit to the generated number's range.
- 5.36 A random floating-point number between 0.0 and 1.0 (not including 1.0)
- 5.37 

```
Random rand = new Random();
randomNumber = rand.Next(100) + 1;
```
- 5.38 

```
Random rand = new Random();
randomNumber = rand.Next(300) + 100;
```
- 5.39 The system time, retrieved from the computer's internal clock
- 5.40 It will always generate the same series of random numbers.
- 5.41 When a form is loaded into memory, before it is displayed
- 5.42 Double-click any area of the form in the *Designer* window, where there is no other control.



## Chapter 6

- 6.1 A `void` method simply executes a group of statements and then terminates. A value-returning method returns a value to the statement that called it.
- 6.2 A header and a body
- 6.3 You are causing the method to execute.
- 6.4 Control of the program goes back to the part of the program that called the method.
- 6.5
- The overall task that the program is to perform is broken down into a series of subtasks.
  - Each subtask is examined to determine whether it can be further broken down into more subtasks. This step is repeated until no more subtasks can be identified.
  - Once all the subtasks have been identified, they are written in code.
- 6.6 A method uses arguments to pass data into the method using parameter variables.
- 6.7 Assignment compatibility applies to argument passing in the following ways:
- You can pass only `string` arguments into `string` parameters.
  - You can pass `int` arguments into `int` parameters, but you cannot pass `double` or `decimal` arguments into `int` parameters.
  - You can pass either `double` or `int` arguments into `double` parameters, but you cannot pass `decimal` values into `double` parameters.
  - You can pass either `decimal` or `int` arguments to `decimal` parameters, but you cannot pass `double` arguments into `decimal` parameters.
- 6.8 The scope of a parameter variable is limited to the method in which it is declared.
- 6.9 A named argument is a parameter variable with a default value.
- 6.10 A copy is passed into the parameter variable, and it does not modify the original argument.
- 6.11 A reference parameter is a reference to the argument it was passed. Any changes done to the parameter are also done to the argument.
- 6.12 The calling method can communicate with the called method by passing an argument.
- The called method can communicate with the calling method by modifying the value of the argument via the reference parameter.
- 6.13 The `ref` keyword
- 6.14 An output parameter works like a reference parameter, but the value passed into it can be uninitialized and it must be set by the method before the method terminates.
- 6.15 A value-returning method returns a value to the caller. A value-returning method can be used to perform a calculation and then return the result.
- 6.16 The Boolean values `true` or `false`
- 6.17 Yes. A method can be written to return any type of data.

## Chapter 7

- 7.1 Value types and reference types
- 7.2 When you are working with a value type, you are using a variable that holds a piece of data, but when you are working with a reference type, you are using two things:
- An object that is created in memory
  - A variable that references the object
- 7.3 The object is like the kite, and the variable that references the object is like the spool of string.
- 7.4 Reference type
- 7.5 `decimal[] monthlyPay;`
- 7.6 `monthlyPay = new decimal[12];`
- 7.7 `const int SIZE = 12;`  
`double[] monthlyPay = new decimal[SIZE];`
- 7.8 `string [] fullName = { "John", "Quincy", "Adams" };`
- 7.9 In any of the following circumstances, you should use a `for` loop to process the array:
- To change the contents of an array element
  - To work through the array elements in reverse order
  - To access some of but not all the array elements
  - To simultaneously work with two or more arrays within the loop
- 7.10 When an object is no longer referenced, it becomes eligible for garbage collection.
- 7.11 A reference to the array
- 7.12 Because arrays are always passed by reference, a method that receives an array as an argument has access to the actual array.
- 7.13 The receiving method not only has access to the array, but it also has access to the reference variable that was used to pass the array.
- 7.14 A method of locating a specific item in a larger collection of data
- 7.15 A technique for scanning through an array and rearranging its contents in some specific order
- 7.16 The values in the array must be sorted in ascending order.
- 7.17 200 rows and 100 columns
- 7.18 `values[199][99] = 50;`
- 7.19 `int[,] values = { { 12, 24, 32, 21, 42 },`  
`{ 99, 8, 68, 32, 92 },`  
`{ 95, 34, 21, 11, 7 } };`
- 7.20 In a traditional two-dimensional array, each row has the same number of columns.
- 7.21 `int[][] values = new int [3][];`  
`values[0] = new int[3] { 2, 4, 6 };`  
`values[1] = new int[4] { 3, 5, 7, 9 };`  
`values[2] = new int[5] { 5, 9, 11, 17, 21 };`

- 7.22 `List<double> valueList = new List<double>() { 1.0, 2.0, 3.0 };`
- 7.23 `valueList.Add(4.0);`
- 7.24 `valueList.Clear();`
- 7.25 Yes. You can use the subscript notation of a `List` to adapt any of the array-processing algorithms so they work with a `List`.

## Chapter 8

- 8.1 `char letter = 'A';`
- 8.2 `MessageBox.Show(letterGrade.ToString());`
- 8.3 `char lastLetter = alphabet[alphabet.Length-1];`
- 8.4 `foreach (char character in serialNumber)`  
`{`  
`MessageBox.Show(character.ToString());`  
`}`
- 8.5 `if (char.IsPunctuation(sentence[sentence.Length-1]))`
- 8.6 `if (char.IsUpper(sentence, 0))`
- 8.7 `uppercase = char.ToUpper(lowercase);`
- 8.8 If the argument is already lowercase, the `ToLower` method returns it unchanged.
- 8.9 `found = dessert.StartsWith("Strawberry");`
- 8.10 If the substring is not found, the methods will return the integer value `-1`.
- 8.11 `city.Trim();`
- 8.12 `vegetable.ToLower();`
- 8.13 `char[] delimiters = { ',', ';' };`
- 8.14 A comma is used as the delimiter for files with the `.csv` extension.
- 8.15 Nothing
- 8.16 The keyword `public` is an access modifier that specifies the field can be directly accessed by statements outside the structure.
- 8.17 When you create an instance of a structure, you are creating an object.
- 8.18 The `new` operator creates an instance of the structure and initializes the object's fields with the default value of `0` or `null` if any of the fields are reference variables.
- 8.19 Once you have created an instance of a structure, you can access its fields using the dot operator.
- 8.20 `motor2 = motor1;`
- 8.21 `Engine [] motors = new Engine[100];`
- 8.22 When the items in two data structures are related by their indexes
- 8.23 a. `Flower`  
b. `1, 2, 3`  
c. `Flower flora = Flower.Petunia;`

- 8.24 The `ToString` method
- 8.25 You can convert an enumerator to its underlying integer type by using a cast operator.
- 8.26 By getting the value of the control's `Images.Count` property
- 8.27 You will find the `ImageList` control in the *Components* section of the *Toolbox*.
- 8.28
- All the images stored in an `ImageList` control should be the same size.
  - The images stored in an `ImageList` control can be no more than 256 by 256 pixels in size.
  - All the images stored in an `ImageList` control should be in the same format (.bmp, .jpg, etc.).
- 8.29 In the *Properties* window, click the ellipses button that appears next to the `Images` property. Click the *Add* button, and an *Open* dialog box will appear. Use the dialog box to locate and select the image file that you want to add to the `ImageList` control.
- 8.30 If you know the index value for a particular image, you can retrieve that image from the `ImageList` control and display it in a `PictureBox`.

## Chapter 9

- 9.1 A class is code that describes a particular type of object. You can think of a class as a code blueprint that can be used to create a particular type of object.
- 9.2 The first line of a class declaration is known as the class header. It starts with the word `class`, followed by the name of the class. Following the class header is an opening curly brace. Next, you write the class's member declarations. These are the statements that define the class's fields, properties, and methods. A closing curly brace appears at the end of the class declaration.
- 9.3 A constructor is a method that is automatically executed when an object is created. In most cases, a constructor is used to initialize an object's fields with starting values.
- 9.4
1. With the project open in Visual Studio, click *PROJECT* on the menu bar and then select *Add Class....*
  2. Select *Class* as the type of item in the *Add New Item* window and then change the name that appears in the *Name* text box to match the name of the class that you are creating.
  3. Click the *Add* button.
- 9.5 When you pass an object that is an instance of a class as an argument, the thing that is passed into the parameter variable is a reference to the object.
- 9.6 A property is a special type of class member that allows an object to store and retrieve a piece of data.
- 9.7 Properties can be passed only by value.
- 9.8 If you need to make a property read only, you simply do not write a `set` accessor for the property.
- 9.9 An error will occur if you try to assign a value to a read-only property.
- 9.10 When field's value is tightly dependent on other data and that field is not updated when the other data is changed, it is said that the field has become stale.
- 9.11 A parameterized constructor is a constructor that accepts arguments.

- 9.12 When a method is overloaded, it means that multiple methods in the same class have the same name, but use different types of parameters.
- 9.13 Binding
- 9.14 If you write a class with no constructor whatsoever, the compiler will provide a default constructor.
- 9.15 The default constructor is a parameterless constructor (it accepts no arguments), and it initializes the object's fields with the value 0. (If any fields are reference variables, they are initialized with the special value `null`.)
- 9.16 When you create an array of a class type, each element of the array is a reference variable. By default, each element is initialized with the value `null`.
- 9.17 You can initialize the array element one element at a time, in a loop, or in the declaration statement of the array.
- 9.18 By writing the class type inside the angled brackets, `<>`, immediately after the word `List`
- 9.19 A written description of the real-world objects, parties, and major events related to the problem.
- 9.20 If you adequately understand the nature of the problem you are trying to solve, you can write a description of the problem domain yourself. If you do not thoroughly understand the nature of the problem, you should have an expert write the description for you.
- 9.21 First, identify the nouns, pronouns, and pronoun phrases in the problem domain description. Then, refine the list to eliminate duplicates, items that you do not need to be concerned with in the problem, items that represent objects instead of classes, and items that represent simple values that can be stored in variables.
- 9.22 The things that the class is responsible for knowing and the actions that the class is responsible for doing
- 9.23 In the context of this problem, what must the class know? What must the class do?
- 9.24 No
- 9.25 Follow these steps to rename a form:
1. Right-click the form's name in the *Solution Explorer*.
  2. Select *Rename* from the pop-up menu.
  3. In the *Solution Explorer*, the form's filename should become highlighted. Type the new name, and press Enter.
  4. When the dialog box appears, click *Yes* to rename the form.
- 9.26 Follow these steps to add a new form to a project:
1. Click *PROJECT* on the Visual Studio menu bar and then select *Add Windows Form...* from the *Project* menu. The *Add New Item* window should appear.
  2. Near the bottom of the *Add New Item* window, a *Name* text box appears where you can specify the new form's file name. Initially, a default name will appear here. Change the default name that is displayed in the *Name* text box to a more descriptive name.
  3. Click the *Add* button.
- 9.27 If you wish to remove a form from a project and delete its file from the disk, follow these steps:
1. Right-click the form's entry in the *Solution Explorer* window.
  2. On the pop-up menu, click *Delete*.

- 9.28 In your application's code, the first step in displaying a form is to create an instance of the form's class.
- 9.29 When the user closes the form, control of the application returns to the point where the `ShowDialog` method was called, and execution resumes.

## Chapter 10

- 10.1 The base class is the general class, and the specialized class is the derived class.
- 10.2 One object is a specialized version of the other object.
- 10.3 It inherits all the base class's members.
- 10.4 `Bird` is the base class and `Canary` is the derived class.
- 10.5 Summary of constructor issues in inheritance.
- When you create an instance of a derived class, the base class constructor is executed first, and then the derived class constructor is executed.
  - When you create an instance of a derived class, by default the base class's parameterless constructor is automatically executed.
  - If you want a parameterized constructor in the base class to execute, you must explicitly call it from the derived class's constructor. You do this by writing the notation `: base(parameterList)` in the derived class's constructor header.
  - If the base class does not have a parameterless constructor, the derived class constructor must use the notation `: base(parameterList)` to call one of the base class's parameterized constructors.
- 10.6 I'm a potato.  
I'm a potato.
- 10.7 No. An object of a base class is not a specialized version of a derived class. Although the statement "a dog is an animal" is true, the statement "an animal is a dog" is not true. This is because all dogs are animals, but not all animals are dogs.
- 10.8 An abstract class is meant to be a base class and never instantiated. It serves as a starting point, providing some members for its derived classes.
- 10.9 It cannot be instantiated.
- 10.10 It must override the abstract method.
- 10.11 It must be overridden in a derived class.
- 10.12 Simply leave out the `set` accessor.

## Chapter 11

- 11.1 A database management system is software that is specifically designed to store, retrieve, and manipulate large amounts of data in an organized and efficient manner.
- 11.2 Most businesses use a DBMS instead of creating their own text files because a DBMS is specifically designed to store, retrieve, and manipulate large amounts of data in an organized and efficient manner. When traditional files contain large amounts of data, simple operations such as searching, inserting, and deleting become cumbersome and inefficient.

- 11.3 The programmer does not need to know specific details about the physical structure of the data because the DBMS handles the actual reading of, writing of, and searching for data. The programmer needs to know only how to interact with the DBMS.
- 11.4
- A database is the data that is stored in a database management system and organized into one or more tables.
  - A table holds a collection of related data that is organized into rows and columns.
  - A row is a complete set of information about a single item in a table of a database.
  - A column holds an individual piece of information about the item in a row of a table in a database.
- 11.5
- c
  - d
  - f
  - b
  - a
  - e
- 11.6 A primary key serves as a unique value that can be used to identify a specific row.
- 11.7 A column that contains unique values that are generated by the DBMS
- 11.8 Leaving the column empty will result in a error.
- 11.9 Application  
Binding source  
Dataset  
Table adapter  
Data source
- 11.10 A table adapter connects to a data source and can retrieve data from a table in a data source. It can also update the table in the data source.
- 11.11 A binding source is a component that can connect user interface controls directly to a dataset.
- 11.12 A user interface control that is connected to a data source is called a data-bound control.
- 11.13 Table adapter  
Adapter manager  
Data set  
Binding source
- 11.14 The `Fill` method causes the table adapter to load data from the database into the dataset.
- 11.15 Visual Studio provides a *Data Sources* window that lets you see all the data sources in the current project. Click *PROJECT* on the Visual Studio menu bar to display the *Data Sources* window.
- 11.16 Create a Details view to display on a single row of a database.
- 11.17 Dragging a table from the *Data Sources* window onto the form creates a `DataGridView` control (by default), complete with a navigation bar, on the form.
- 11.18 The project's output folder is the *bin\Debug* folder.

- 11.19 When you click the smart tag, a tasks panel will pop up, giving you a number of options that you can perform with the control.
- 11.20 The type of control to which a column is automatically bound is determined by the column's data type.
- 11.21 To bind a ListBox control to a column, you must set two of the control's properties: DataSource and DisplayMember.
- 11.22 The table adapter's Fill method
- 11.23 You use the select statement to retrieve the rows in a table.
- 11.24 Queries
- 11.25 In SQL, the equal to operator is one equal sign, not two equal signs, and the not equal to operator is <>.
- 11.26 If you need to include a single quote as part of a string, simply write two single quotes in its place.
- 11.27 The Like operator can be used to search for a substring in a column.
- 11.28 Unlike the % character, the underscore represents a single character.
- 11.29 The Order By clause
- 11.30 The @ symbol



*This page intentionally left blank*

# Index

## Symbols

- & (ampersand), 181
- && (AND operator)
  - defined, 223
  - example of, 223
  - truth table for, 224
- = (assignment operator), 85
- \$ (dollar sign), 151
- ! (NOT operator)
  - defined, 223, 225
  - example of, 225
  - truth table for, 225
- || (OR operator)
  - defined, 223, 224
  - example of, 224
  - truth table for, 224
- ; (semicolon), 74
- . (period) delimiter, 493
- = operator, 142
- / = operator, 142
- / (division) operator, 138
- (subtraction) operator, 138
- @ (at symbol) delimiter, 493
- ! = operator, 201
- % = operator, 142
- \* = operator, 142
- + = operator, 142
- = operator, 502
- = = operator, 199, 200–201, 229
- < = operator, 200
- > = operator, 200
- + (addition) operator
  - defined, 138
  - enum variable, 517
  - implicit string conversion with, 147
  - with string and enum variable, 517
- % (modulus) operator, 138, 139
- \* (multiplication) operator, 138

## A

- Abstract classes
  - defined, 621–622
  - example, 622
  - general format, 622
  - properties, 622
  - regular classes *vs.* 622
  - tutorial, 623–627
- Abstract keyword, 622
- Abstract methods, 622
- Abstract properties, 622
- Accept buttons, 181
- AcceptButton property, 181
- Access keys
  - assigning to buttons, 180–181
  - case sensitivity, 181
  - defined, 180
  - same assignment, to multiple buttons, 181
- Access modifiers
  - defined, 168
  - private, 168
  - public, 341
- Accessors
  - defined, 547
  - writing, 549
- Account Simulator* application
  - BankAccount class
  - BankAccount.cs file code, 558–559
  - defined, 556
  - form, 556
  - Form1 code, 559–560
- Actual arguments, 352
- Actual parameters, 352
- Ada, 15
- Add Connection dialog box (Visual Studio), 659–660
- Add method
  - for adding objects to Lists, 563–564
  - for adding structure objects to Lists, 505–506
  - for adding to Lists, 447
- Add New Item window illustrated, 540–541
  - opening, 540
  - Phonebook application, 639
- Add Two Numbers application, 235–236
- Algorithms
  - array, 414–428
  - binary search, 434–436
  - defined, 25
  - flowchart symbols, 26
  - selection sort, 429–434
  - sequential search, 450–451
- Alignment
  - if-else-if statement, 222
  - of nested decision structures, 217–218
- Alphabetical button (*Properties* window), 57
- American Standard Code for Information Interchange (ASCII)
  - defined, 10
- Ampersand (&), 181

- And operator (SQL), 681
- AND operator (&&)
  - defined, 223
  - example of, 223
  - truth table for, 224
- Angle brackets (<>), 447
- Animal class, 612–617
- Appending data
  - code, 301
  - to existing files, 301–302
  - illustrated, 302
  - tutorial, 302–303
- Application software, 6
- Applications
  - Account Simulator*, 556–560
  - Add Two Numbers*, 235–236
  - Argument Demo*, 350–351
  - Array Argument*, 408–409
  - binding source, 638
  - Birth Date String*, 128–131
  - Car Demo*, 597–600
  - Car List*, 506–508
  - Car Truck SUV Demo*, 601–603
  - Card Flip*, 100–103
  - Cards*, 352–355
  - CD Account Test*, 604–609
  - Cell Phone Inventory*, 564–567
  - Cell Phone Test*, 550–554
  - Change Array 1*, 411–412
  - Change Array 2*, 412–413
  - Change Counter*, 171–175
  - CheckBox*, 244–245
  - Coin Toss*, 325–327, 539, 542–546
  - Colonies*, 414–416
  - Color Spectrum*, 517–519
  - Color Theme*, 246–248
  - Computer Science Student*, 623, 625–626
  - CSV Reader*, 494–495, 497
  - Cups To Ounces*, 372–374
  - data source, 640
  - DBMS interaction with, 636
  - Display Elements*, 395–396
  - Ending Balance*, 273–279
  - ErrorProvider Demo*, 719–720
  - Field Demo*, 169–170
  - File To Array*, 405–407
  - Flags*, 96–99
  - Friend File*, 297–303
  - Fuel Economy*, 148–151, 237–239
  - Full Name*, 378–380
  - Grader*, 218–220

- Applications (*continued*)
  - Grader2*, 221–222
  - HScrollBar Demo*, 715–716
  - Language Translator*, 88–90
  - Lights*, 345–348
  - Load Event*, 329–331
  - Loan Qualifier*, 214–217
  - Lottery Numbers*, 399–401
  - Max*, 355–356
  - Multiform Products*, 672, 676, 682
  - Name List*, 267–268
  - North America*, 363–367
  - Number List*, 268
  - Numeric Data*, 307–309
  - Partially Filled Array*, 422–424
  - Pass By Ref*, 361–362
  - Pass By Value*, 358–359
  - Password Validation*, 471–474
  - Pay and Bonus*, 375–378
  - Payroll with Overtime*, 208–211
  - Phone Book*, 647–648, 654–655, 664
  - Phonebook*, 509–513
  - Polymorphism*, 616–621
  - Presidential Trivia*, 86
  - Product Lookup*, 669–671
  - Product Queries*, 684–691
  - Products*, 672–677
  - RadioButton*, 243–244
  - Random Card*, 524–526
  - Sales Price Calculator*, 154–157
  - Seating Chart*, 439–443
  - Secret Word*, 229–230
  - Selected Text Demo*, 722–723
  - Selection Sort*, 432–434
  - Simple Method*, 343–344
  - South America*, 310–313
  - Speed Converter*, 286–289
  - Squares*, 283–284
  - Sum*, 369–371
  - TabControl Demo*, 717
  - table adapter, 638
  - Telephone Format*, 484–487
  - Telephone Unformat*, 488–491
  - Test Average*, 162–166, 424–428
  - Test Score Average*, 202–206
  - Test Score List*, 452–456
  - Time Zone*, 253–256
  - Total Sales*, 314–316
  - WebBrowser Demo*, 718–719
- Argument Demo* application, 350–351
- Arguments
  - actual, 352
  - default, 357–358
  - defined, 144, 349, 352
  - formal, 352
  - named constants, 357
  - parameter data type compatibility, 355
  - passing, 349–360
  - passing arrays as, 407–413
  - passing by reference, 360–367
  - passing variables as, 351
- Array Argument* application, 408–409
- Array elements
  - accessing in two-dimensional arrays, 438–439
  - default values, 394–395
  - defined, 394
  - initializing in declaration statement, 563
  - null value, 394, 562
  - stepping through with enum variable, 521
  - subscripts, 394–398
  - swapping, 431–434
  - two-dimensional arrays, summing, 443
  - working with, 395–397
- Array To File* project, 404–405
- Arrays
  - advanced search algorithms, 429–436
  - algorithms, 414–428
  - binary search algorithm, 434–436
  - of class type objects, 562–563
  - comparing, 417–418
  - contents, writing to file, 404–405
  - copying, 416–417
  - declaring, 394
  - defined, 392, 393, 401
  - files and, 404–407
  - foreach loops with, 401–402
  - initialization, 397
  - initialization list, 397
  - jagged, 445–446
  - Length property, 398–399
  - List objects *vs.*, 446
  - for listing random lottery numbers, 399–401
  - loops for stepping through, 397–398
  - one-dimensional, 436
  - parameters, ref and out with, 410–413
  - partially filled, 422–424
  - processing, 424–428
  - processing items in, 392
  - as reference type, 393
  - reference variables, reassigning, 402–403
  - selected sort algorithm, 429–434
  - size declarator, 393, 394
  - storing file values in, 405–407
  - two-dimensional, 436–444
  - values, averaging, 418–419
  - values, highest and lowest, 419–421
  - values, totaling, 418
- ASCII. *See* American Standard Code for Information Interchange (ASCII)
- Assembler, 14
- Assembly language, 13–14
- Assignment, one structure to another, 502
- Assignment compatibility
  - decimal variables, 136
  - double variables, 136
  - int variables, 135–136
  - variables, 126–127
- Assignment operators
  - combined, 142–143
  - defined, 85
- Assignment statement, 85
- Auto Hide, 34–35
- Automobile class, 595–597, 600–601
- AutoPopDelay property, 712
- AutoSize property
  - as Boolean property, 83
  - defined, 83
  - illustrated, 83, 84
  - Label controls, 83–84
- avg function (SQL), 692
- B**
  - BackColor property, 182, 183
  - BackgroundImage property, 183
  - BackgroundImageLayout property, 183–184
  - Backing fields, 547–548, 555, 596, 600–601, 605, 612–614
  - BankAccount class, 556–558, 560–561
  - Base classes. *See also* Inheritance; Constructors
    - defined, 594
    - “is a” relationship, 593–594
    - methods, derived class methods overriding, 615
    - parameterized constructors, 610–611
    - parameters, passing objects to, 616
    - reference variables, 615
  - base keyword, 611
  - BASIC, 15
  - Binary digits. *See* Bits (binary digits)
  - Binary files, 293
  - Binary numbering system, 8–9
  - Binary search algorithm
    - Arrays defined, 434
    - method performing, 435–436
    - pseudocode, 436
    - variables to mark positions, 435
  - Binary Search* application, 436
  - BinarySearch method, 435–436
  - Binding, 561
  - Binding source, 638
  - Birth Date String* application, 128–131
    - control property settings, 129
    - form, 128
    - Form1 code, 130–131
    - illustrated, 130
  - bit data type (SQL), 636
  - Bits (binary digits)
    - defined, 7
    - pattern illustrations, 7, 9
    - values of, 8
  - Blank lines
    - use of, 104, 106
  - Block comment, 105

- Body, loop
  - for loop, 282–283
  - statement execution, 270
- Body, method
  - defined, 341
  - statements, 342
- bool data type, 709
- bool variable, 228
- Boolean
  - AutoSize property as, 83
  - Visible property as, 99, 100
- Boolean expressions
  - % operator in, 374
  - compound, 226
  - defined, 199
  - if-else statement and, 207
  - and relational operators, 199–201
  - using logical operators, 223
- Boolean methods. *See also* Methods
  - defined, 374
  - to modularized input validation, 375–378
  - return values, 374
- BorderStyle property, 82–83
  - defined, 82
  - examples, 82
  - Panel control, 186
  - PictureBox control, 95
  - selections, 83
- Bounding box, 54
- Braces, 69–70
- Break mode, 158
- Button controls
  - Click event handler, 73
  - creation of, 58, 65
  - default names, 59
  - moving, 65
  - multiple, with event handlers, 75–76
  - Text property of, changing, 59–60, 65
- Buttons
  - access keys, assigning, 180–181
  - defined, 22
  - radio, 241–244
- byte data type, 709
- Bytes
  - defined, 7
  - illustrated, 7
  - for large numbers, 9
- C**
- C#
  - code, 67–77
  - data type, 709
  - defined, 15
  - development settings, selecting, 30
  - identifiers, 61–62
  - introduction, 53–117
  - keywords, 16
  - .NET Framework and, 22–23
- C language, 15
- C++ language, 15
- Calculations, performing, 138–143
- Calling methods
  - method execution and, 343
  - operations behind the scenes, 344
  - process, 343–344
  - tutorial, 345–348
  - value-returning, 341
  - void, 341
- CamelCase naming convention, 62
- CancelButton property, 181
- car class, 574, 595–598
- Car Demo* application
  - defined, 598
  - form, 598
  - Form1 code, 598–600
  - Form1 form, 598
- Car List* application
  - data display, 506–507
  - defined, 506
  - form, 506
  - Form1 code, 507–508
  - running, 506
- Car Truck SUV Demo* application
  - defined, 601
  - Form1 code, 601–602
  - Form1 form, 601
  - message boxes displayed by, 603
- Card Flip* application
  - Control property settings, 102
  - creating, 100–103
  - form, 101
  - Form1 code, 102–103
  - illustrated, 101
- Cards* application
  - defined, 352
  - form, 352
  - Form1 code, 353–355
- Cast operators
  - applied to variables, 137
  - defined, 137
  - explicitly converting values with, 136–137
  - in math expressions, 141
  - usage examples of, 137
- cat class, 614–615
- Catch blocks, 158
- catch clause, 158
- Categorized button (*Properties* window), 57
- CD (compact disc), 5
- CD Account Test* application
  - CDAccount.cs* file code, 607
  - defined, 604–605
  - form, 604–605
  - Form1 code, 607–609
  - SavingsAccount and CDAccount classes, 603–606
  - SavingsAccount.cs* file code, 606–607
  - testing classes, 603–604
- CDAccount class, 603–606
- Cell Phone Inventory* application
  - completing, 564–567
  - defined, 564
  - form, 564
  - Form1 code, 566–567
- Cell Phone Test* application
  - CellPhone class, 551–554
  - CellPhone.cs* file, 552–553
  - defined, 551
  - form, 551–552
  - Form1 code, 553–554
- Central processing units (CPU)
  - as computer’s brain, 11
  - defined, 3
  - in ENIAC computer, 3–4
  - fetch-decode-execute cycle, 13
  - instruction execution, 12–13
  - instruction set, 12
  - manufacturers, 12
  - microprocessors, 4
  - operations, 11–12
- Change Array 1* application
  - ChangeArray method, 411–412
  - form, 410
  - goButton\_Click event handler, 411
- Change Array 2* application, 412–413
- Change Counter* application
  - control property settings, 172
  - creating, 171–175
  - form, 171
  - Form1 code, 174–175
- ChangeArray method, 411–412
- ChangeMe method, 359
- char data type
  - declaring, 467
  - defined, 466, 709
  - testing methods, 467–470
- Character literals, 467
- Character testing methods
  - char.IsDigit, 468
  - char.IsLetter, 468
  - char.IsLetterOrDigit, 468
  - char.IsLower, 469
  - char.IsPunctuation, 469
  - char.IsUpper, 470
  - char.IsWhiteSpace, 470
  - char.ToLower, 470
  - char.ToUpper, 470
- Characters
  - case conversion, 474
  - position methods, 476
  - retrieving, in a string, 466–467
  - storage of, 9–10
  - Unicode representation, 230
  - white-space, 470
- char.IsDigit, 468
- char.IsLetter, 468
- char.IsLetterOrDigit, 468
- char.IsLower, 469
- char.IsPunctuation, 469
- char.IsUpper, 470
- char.IsWhiteSpace, 470

- `char.ToLower`, 470
- `char.ToUpper`, 470
- Check boxes
  - creation of, 244–245
  - defined, 244
  - illustrated, 244
- CheckBox* application, 244–245
- CheckBox control
  - Checked property, 244
  - CheckedChanged event handler, 245
  - defined, 244
  - Text property, 244
  - working with in code, 244–245
- Checked menu items
  - defined, 724
  - using, 727–728
- Checked property
  - CheckBox control, 244
  - menu items, 727–728
  - RadioButton controls, 242–243
- CheckedChanged event, 245
- CheckOnClick property, 727
- `circle` class, 554–555
- Class declarations
  - format of, 539
  - where to write, 539–542
  - writing, 536–537
- Class instances
  - defined, 536
  - derived class, 594–597
  - form, creating, 581–583
- Class type objects
  - arrays of, 562–563
  - Lists of, 563–564
  - storing, 562–567
- Classes
  - abstract, 621–622
  - Animal*, 612–614
  - Automobile*, 595–597
  - base, 594–596
  - Car*, 574
  - CDAccount*, 603–606
  - Coin*, 537–539
    - creating, 536–38
  - Customer*, 573–574
  - defined, 22, 69
  - derived, 594–597
  - Dog*, 612–614
  - introduction to, 535–536
  - Math*, 175–177
  - naming, 537
  - as object blueprint, 535–536
  - potential, list of, 569–572
  - Random*, 323, 391–392
  - Rectangle*, 609–610
    - as reference types, 539
    - responsibilities, 568–576
    - responsibilities in problems, 568–571
  - SavingsAccount*, 603–606
  - ServiceQuote*, 575–576
  - SportUtility*, 595, 600–603
    - StreamReader*, 294, 304–313
    - StreamWriter*, 294, 304
    - Truck*, 595, 600–602
      - writing, 23
- `clear` method, 450
- Click event handler
  - for Button control, 73
  - creation of, 76
  - for menu system, 729
  - PictureBox control, 95
  - writing, 75
- Clickable images, 95–96
- Closing files, 292
- COBOL, 14, 15
- Code. *See* Source code
- Code editor
  - class file display in, 541
  - defined, 67
  - detaching, 71
  - with empty event handler, 78
  - IntelliSense, 91–92
  - opening *Form1.cs* in, 68
  - returning to docked position, 71
  - switching between *Designer* and, 70–71
- Code window, 131
- `coin` class
  - creating and using tutorial, 542–544
  - defined, 538
  - source code, 540
- Coin Toss* application
  - Coin.cs*, 543
  - Coin.cs* code, 544–545
  - completing, 544–545
  - control property settings, 325
  - example output, 544
  - form, 325
  - Form1 code, 327, 545
  - repositioned controls, 326
- Colonies* application
  - Click event handler, 416
  - defined, 414
  - form, 414
  - `SequentialSearch` method, 414–415
- Color Spectrum* application
  - completing, 517–519
  - defined, 517
  - form, 518
  - Form1 code, 518–519
- Color Theme* application
  - control property settings, 246
  - creating, 246–248
  - form, 246
  - Form1 code, 247–248
- Colors
  - default, 183
  - setting in code, 182–183
- Column Properties* window, 642
- Columns. *See also* Tables
  - binding with ListBox controls, 669
  - data types, 635–636
- identity, 637
- null values, 637
- selecting data-bound control for, 648
- two-dimensional arrays, summing, 444
- Combined assignment operators, 142–143
- Combo boxes
  - defined, 712
  - drop-down, 713
  - drop-down list, 713
  - getting user input from, 714
  - list boxes *vs.*, 713, 714
  - simple, 712, 713
  - styles of, 713–714
- Comma separated value (CSV) file format, 495
- Command line interface
  - defined, 18
  - illustrated, 19
- Comments
  - block, 105
  - defined, 104
  - documentation, 105–106
  - line, 104–105
  - types of, 104
- Compact disc (CD), 5
- Comparing arrays, 417–418
- Comparing structure objects, 504
- Compilers, 16–17
- Computer programming, 1
- Computer Science Student* application
  - completing, 623–627
  - CompSciStudent.cs* file code, 625–626
  - defined, 623
  - form, 623
  - Form1 code, 626–627
  - Student.cs* file code, 625–626
- Computers
  - CPU, 3–4
  - data storage, 7–11
  - ENIAC, 3–4
  - hardware, 2–5
  - input devices, 5
  - main memory, 4
  - output devices, 5
  - secondary storage devices, 4–5
  - software, 1, 2, 6
- Concatenation
  - defined, 123
  - strings, 123–125
- Conditional execution, 198
- Console interface. *See* Command line interface
- `const` keyword, 171
- Constant field
  - declaring, 171
  - defined, 170
  - value, 171
- Constructors
  - base class, 609–611
  - default, 562

- defined, 555
- derived class, 609–611
- inheritance and, 611
- overloaded, 561–562
- parameterized, 555–562
- Contains method, 475
- Control property settings
  - Birth Date String* application, 129
  - Card Flip* application, 102
  - Change Counter* application, 172
  - Color Theme* application, 246
  - Flags* application, 97
  - Fuel Economy* application, 149
  - Language Translator* application, 89
  - Presidential Trivia* application, 86
  - Sales Price Calculator* application, 155
  - Test Average* application, 163
  - Time Zone* application, 254
- Control structures
  - defined, 197
  - do-while loop, 289–291
  - for loop, 281–289
  - while loop, 269–272
- Controls
  - adding to form, 57–59
  - Button, 58–60
  - data-bound, 648–649
  - DataGridView, 648–654
  - defined, 22
  - deleting, 59
  - Details view, 656–665
  - focus, 177, 178, 179–180
  - GroupBox, 184–185
  - HScrollBar, 715
  - identifiers, 61–62
  - identifying by names, 55
  - ImageList, 522–526
  - Label, 80–90
  - ListBox, 251–253
  - MenuStrip, 724–725
  - moving, 58–59
  - Name property, changing, 60–61
  - naming, 61–62
  - OpenFileDialog, 317–320
  - organizing, 184–186
  - Panel, 186
  - PictureBox, 92–104
  - RadioButton, 242–244
  - renaming, 60–61
  - resizing, 58–59
  - SaveFileDialog, 317, 320–322
  - TabControl, 716
  - TabPage, 716–717
  - TextBox, 119–121, 235–237
  - Toolbox, 57–58
  - ToolTip, 711–712
  - VScrollBar, 715
  - WebBrowser, 718
- Copying arrays, 416–417
- Count property, 447, 524
- Counter variables
  - declaring in initialization
    - expression, 285
  - declaring in update expression, 285
  - decrementing, 285–286
  - defined, 272
  - for loops and, 286
- CSV Reader application
  - completing, 494–498
  - defined, 494
  - form, 495
  - Form1 code, 497–498
  - Microsoft Excel spreadsheet, 494
  - test averages display, 497
- Cups To Ounces* application
  - defined, 372
  - form, 372
  - Form1 code, 373–374
- Curly braces (`{}`)
  - for conditionally executed statements, 207
  - do-while loops, 290
  - for loops, 281–282
  - in method body, 342
  - while loops, 270
- Currency format, 152, 154–157
- customer class, 573–574
- D**
- Data-bound controls
  - DataGridView, 665–667
  - defined, 665
  - Details view controls, 656–664
  - on multiple forms, 663–668
  - placement on forms, 671
  - selecting, 659
  - using, 664–665
- Data source, 638–640
- Data Source Configuration Wizard*
  - data connection selection, 648, 650
  - data source type selection, 647, 649
  - database model selection, 648, 650
  - database objects selection, 650, 660
  - saving connection string, 659–660
  - window, 640
- Data Sources* window, 651–652, 663
- Data storage, 7–11
  - advanced number, 10
  - characters, 9–10
  - digital data, 10–11
  - numbers, 8–9
  - object, 21
- Data types. *See also* Reference types; Value types
  - argument and parameter compatibility, 375
  - bool, 228
  - categories, 389
  - char, 466
  - datetime, 606, 636
  - decimal, 636
  - decimal, 134
  - defined, 122
  - double, 134
  - enumerated, 514–517
  - float, 636
  - int, 134, 636
  - Microsoft SQL Server, 636
  - mixing, in math expression, 141
  - money, 636
  - nchar, 636
  - numeric, 133–134
  - nvarchar, 636
  - primitive, 122, 709
  - string, 123, 636
- Database management systems (DBMSs)
  - C# application interacting with, 634
  - column data types, 635–636
  - defined, 633
  - examples of, 634
  - functioning of, 633–634
  - identity columns, 637
  - introduction to, 633–634
- Databases
  - connecting applications to, 638
  - copies at runtime, 665
  - creating in Visual Studio, 651–652
  - defined, 634
  - existing, connecting to, 656–664
  - file location, 647
  - model selection, 649
  - objects selection, 651
  - tables, 635
- DataGridView controls
  - auto-generated code, 654
  - buttons, disabling, 667
  - customizing, 665–667
  - defined, 648
  - placed on form, 653
  - smart tag, 665–666
  - tasks panel, 665–666
  - tutorial, 648–654
- DateTime, 606
- Debugging, source code, 27
- decimal data type, 636
  - defined, 134, 709
- decimal literal, 135
- decimal variables
  - arrays of, 393
  - assignment compatibility, 136
  - defined, 134
- decimal.Parse method, 144–145
- decimal.TryParse method, 233
- Decision structure
  - combining sequence structures
    - with, 212
  - conditional execution, 198
  - defined, 197
  - dual-alternative, 206–207
  - if-else statement, 206–211
  - if statement, 197–206
  - multiple-alternative, 248

- Decision structure (*continued*)
    - nested, 212–222
    - single-alternative, 198–199
    - switch statement, 248–251
  - Decrementing
    - counter variables, 285–286
    - defined, 280
    - variables, 280–281
  - Default arguments
    - defined, 357
    - use example, 357–358
    - use guidelines, 358
  - Default constructors, 562
  - Delimiters
    - @ (at symbol), 493
    - . (period), 493
    - defined, 489
  - Derived classes. *See also* Inheritance
    - defined, 594
    - “is a” relationship, 593
    - methods overriding base class
      - methods, 590
      - polymorphism, 589
  - Design time, 76–77
  - Designer window
    - defined, 33–34
    - displaying, 41
    - illustrated, 34
    - switching between code editor and, 70–71
  - Details view, 656–657
    - control-type selection, 667–669
    - creating, 657
    - customizing, 667–669
    - defined, 656–657
    - illustrated, 657
    - Label controls, 657
    - placing on form, 664
    - tutorial, 657–664
  - Dialog box, 73. *See also*
    - Message boxes
    - Font, 81, 82
    - String Collection Editor, 252
  - Digital data, 10–11
  - Digital versatile disc (DVD), 5
  - Direct access files, 293
  - Disabled menu items
    - defined, 724
    - using, 728
  - Disk drives
    - defined, 4
    - external, 4–5
    - floppy, 5
  - Display Elements application, 395–396
  - DisplayAuto method, 503
  - DisplayList method, 448–449
  - DisplayMember property, 669
  - DisplayNames method, 510–513
  - DisplayValue method, 349–350
  - Divide and conquer approach, 339, 340
  - do-while loops
    - curly braces, 290
    - defined, 289
    - general format, 290
    - iterations, 290–291
    - logic, 290
    - as posttest loop, 289, 290
  - Documentation (Visual Studio), 41–42
  - Documentation comments, 105–106
  - Dollar sign (\$), 151
  - Dot (.) operator, 493
  - double data type
    - defined, 134, 709
  - double literal, 135
  - double variables
    - assignment compatibility, 136
    - defined, 134
  - double.Parse method, 144
  - double.TryParse method, 233, 234
  - Drop-down combo boxes, 713
  - Drop-down list combo boxes, 713–714
  - Dual-alternative decision structure
    - defined, 206
    - illustrated, 206
    - writing, 207
  - DVD (digital versatile disc), 5
- E**
- Elements, array
    - accessing in two-dimensional arrays, 438–439
    - default values, 394–395
    - defined, 394
    - initializing in declaration
      - statement, 563
    - null value, 394, 562
    - stepping through with enum
      - variable, 516
    - subscripts, 394–398
    - swapping, 431–434
    - two-dimensional arrays, summing, 443
    - working with, 395–397
  - else clause, 207
    - alignment of, 218
  - End terminal symbol, flowchart, 26
  - Ending Balance application
    - defined, 273
    - enhancing, 276–279
    - example output, 277
    - form, 273
    - Form1 code, 274–276, 277–279
    - loop calculation in, 273–276
    - modified form, 276
  - EndOfStream property, 309
  - EndsWith method, 475
  - ENIAC computer, 3–4
  - Enum declarations, 515
  - enum variables, 515
    - compared with integer values, 520–521
    - defined, 514
    - enumerator comparison, 520–521
    - integer value, getting, 520
    - for stepping through arrays, 521
    - ToString method, 517
  - Enumerated data types, 515. *See also*
    - Data types
      - defined, 514
      - multiple, 516
  - Enumerators
    - compared with integer values, 520–521
    - as constants representing integer
      - values, 514–515
    - declaring, 515
    - defined, 514–515
    - enum variable comparison, 520–521
    - integer value, getting, 520
    - as legal C# identifiers, 515
    - specifying integer values for, 520
    - ToString method, 517
  - Equal to (==) operator, 199, 200–201, 229
  - Error List window, 108
  - ErrorProvider component, 719–720
  - ErrorProvider Demo application, 719–720
  - Errors
    - logic, 27
    - off-by-one, 401
    - syntax, 17, 27, 107–108
  - Event-driven GUI programs, 20
  - Event handler
    - CheckedChanged, 245
    - Click (*See* Click event handler)
      - code, 73
    - code generation illustration, 72
    - defined, 71
    - for displaying message box, 74
    - empty, 78
    - statements written inside, 79
  - Event handlers
    - defined, 71
    - Load, 328–331
    - multiple Button controls with, 75–76
  - Exception handler
    - defined, 159
  - Exception handling, 158–162
    - default error message, displaying, 160–162
    - file-related exceptions, 296
    - process, 158–159
    - tutorial, 162–166
  - Exception objects
    - defined, 160
    - properties, 161

- Exceptions
  - data conversion, prevention with `TryParse` methods, 232–239
  - default error message, displaying, 160–162
  - defined, 145, 158
  - file-related, 296
  - reported, 146, 159
- Exponential format, 152
- F**
- Fetch-decode-execute cycle, 13
- Field Demo* application
  - form, 169
  - Form1 code, 169–170
- Fields
  - backing, 547–548
  - constant, 170–171
  - declarations, 168, 499–500
  - defined, 21, 167
  - lifetime of, 170
  - precautions, 170
  - public, 547, 549–550
  - scope of, 167
  - stale, 555
  - structure, 499–500
  - variables declaring as, 167–175
- File menu, 729
- File objects, 293–294
- File To Array* application, 405–407
- `File.AppendText` method, 301, 304
- `File.CreateText` method, 294–295, 301, 304
- Filename property
  - `OpenFileDialog` control, 319–320
  - `SaveFileDialog` control, 321–322
- Filenames, 293
- Files
  - access methods, 293
  - appending data to, 301–303
  - arrays and, 404–407
  - binary, 293
  - closing, 292
  - for data storage, 291–317
  - defined, 294
  - direct access, 293
  - exceptions, handling, 296
  - input, 292
  - opening, 292
  - output, 292, 304
  - processing, 292
  - program storing data in, 291
  - reading data from, 292
  - reading values for arrays, 405–407
  - schema definition, 682
  - sequential access, 293
  - text, 293, 300–299, 307–309
  - types of, 293
  - use steps, 292
  - writing array contents to, 404–405
  - writing data to, 292
  - writing data to, with `StreamWriter` object, 294–295
  - writing data to, with `write` method, 295–296
- `Fill` method, 671
- Fixed-point scientific format, 152
- Flags, 228
- Flags* application
  - control property settings, 97
  - creation of, 96–99
  - form, 97
  - Form1 code, 98
  - running, 99
- Flash memory, 5
- `Flip` method, 546
- `float` data type, 636, 709
- Floating-point notation, 10
- Floppy disk drive, 5
- Flowcharts
  - defined, 26
  - highest value in array, 420
  - illustrated example, 26
  - lowest value in array, 421
  - nested decision structures, 212–213
  - symbols, 26
  - `while` loop, 272
- Focus
  - changing, with `Focus` method, 179–180
  - controls capable of, 178
  - defined, 177
- `Focus` method, 179–180
- Font* dialog box, 81, 82
- Font property, 81–82
  - attributes, 82
  - defined, 81
  - illustrated, 81
- for loops. *See also* Control structures; Loops
  - actions specified by, 281
  - body, 282–283
  - counter variables and, 286
  - curly braces, 281–282
  - defined, 281
  - execution, 283
  - `foreach` loops *vs.*, 402
  - general format, 281
  - initialization, 284
  - initialization expression, 282, 285
  - logic, 281–282, 283
  - loop header, 281–282
  - as pretest loops, 284–285
  - sequence of events in, 283
  - test, 284
  - test expression, 282
  - tutorial, 286–289
  - update, 284
  - update expression, 282, 285
  - using, 286–289
- `foreach` loops
  - with arrays, 401–402
  - components, 402
  - defined, 401
  - for loops *vs.*, 402
  - general format, 401–402
  - with iteration variables, 401
  - for retrieving characters in a string, 465
  - for structure arrays, 502
- `ForeColor` property, 182
- Form1 form
  - defined, 576
  - renaming, 577–578
- Form files, renaming, 577–578
- Formal arguments, 352
- Formatting strings
  - defined, 151
  - list of, 152
- Form1.cs file
  - code (example of), 87
  - code (organization of), 69
  - code (in Visual Studio code editor), 68
  - defined, 67
  - opening, in code editor, 68
- Forms
  - adding controls to, 57–59
  - adding new, to project, 578–579
  - adding to projects, 578–579
  - background images for, 183–184
  - bounding box, 54
  - modal, 585
  - modeless, 585
  - with multiple `Button` controls, 75
  - removing, 580
  - resizing, 54–55, 64
  - `Size` property, 57
  - sizing handles, 54
  - Solutions Explorer* window, 581
  - source code, 580
  - switching between form code and, 579–580
  - tab order, 177–179
  - `Text` property, 55, 56, 64
  - FORTTRAN, 15
- Forward slashes (`//`), 105
- Friend File* application
  - appending data in, 302–303
  - defined, 297
  - form, 297
  - Form1 code, 299–300, 303
  - `Friend.txt` file, 302–303
  - text file, opening, 298
  - text file contents, 299
  - writing data to text file, 297–300
- Fuel Economy* application
  - calculating, 237–239
  - control property settings, 149
  - form, 148, 237
  - Form1 code, 150, 238–239
  - illustrated, 149
  - invalid input, 238



- Full Name* application
  - defined, 378
  - example output, 380
  - form, 378
  - Form1 code, 378–379
- G**
- Games, 291
- Garbage collection, 403
- Generalization, 593
- Grader* application
  - form, 219
  - nested decision structure, 219
  - testing series of conditions, 218–220
- Grader2* application, 221–222
- Graphical user interfaces (GUIs)
  - check boxes, 244–245
  - combo boxes, 712–714
  - defined, 18, 19
  - designing, in development cycle, 24–25
  - event-driven programs, 20
  - illustrated, 19
  - list boxes, 251–256
  - objects in, 21
  - radio buttons, 241–244
- Greater than (>) operator, 199
- Greater than or equal to (>=) operator, 200
- GroupBox control
  - adding controls to, 185
  - creating, 185
  - defined, 184
  - deleting, 185
  - illustrated, 184
  - moving, 185
  - moving existing controls to, 185
  - Panel controls *vs.*, 186
  - tab order, 185
  - TabIndex property, 185
  - Text property, 184
- GUIs. *See* Graphical user interfaces (GUIs)
- H**
- Hardware, 2–5
  - components, 2
  - CPU, 3–4
  - defined, 2
  - illustrated, 3
  - input devices, 5
  - main memory, 4
  - microprocessors, 4
  - output devices, 5
  - secondary storage devices, 4–5
- Header, method
  - defined, 341
  - parts of, 341–342
  - semicolon termination and, 342, 343
- Height property, 610
- Hello World* program
  - creating GUI for, 63–66
  - defined, 62
  - running, 66, 80
  - writing code for, 77–80
- Help* menu, 729
- High-level languages. *See also* specific Programming languages
  - defined, 14
  - functioning of, 14–15
  - statements, 16
- HScrollBar control, 715
- HScrollBar Demo* application, 715–716
- I**
- IDE. *See* Integrated development environment (IDE)
- Identifiers, 61–62
- Identity columns, 637
- If-else-if statement
  - alignment of, 222
  - defined, 220
  - indentation of, 222
  - logic of, 222
  - switch statement as alternative to, 250–251
- If-else statement
  - and Boolean expression, 207
  - defined, 206
  - format of, 207
  - parts of, 207
- If statement
  - decision structures, 197–206
  - example of, 201
  - format of, 199
  - relational operators, 199–201
  - writing, 201
- Image editors, 291
- Image property
  - defined, 93
  - Select Resource* window, 93
- ImageList controls, 522–524
  - defined, 522
  - illustrated, 522
  - Images property, 522
  - ImageSize property, 522
  - use guidelines, 522
- Images
  - background, 183–184
  - clickable, creation of, 95–96
- Images Collection Editor* window, 522–523
- Images property, 522
- ImageSize property, 522
- Incrementing, 280–293
- Indentation
  - if-else-if statement, 222
  - loop body statements, 270
  - of nested decision structures, 217–218
  - use of, 104, 106
- IndexOf method, 451, 476–478
- Infinite loops, 279
- Inheritance
  - base class, 594
  - base class constructor, 609–611
  - constructor issues in, 611
  - defined, 594
  - derived class, 594
  - derived class constructor, 609–611
  - example, 594–603
  - “is a” relationship and, 593–603
  - notation in a class header, 596
- InitialDelay property, 712
- InitialDirectory property
  - OpenFileDialog control, 320
  - SaveFileDialog control, 322
- Initialization, variables, 132
- Initialization expression
  - declaring counter variable in, 285
  - defined, 282
- Initialization list
  - defined, 397
  - two-dimensional arrays, 439
- Input
  - devices, 5
  - files, 292
  - reading, with TextBox control, 119–121
- Input symbols, flowchart, 26
- Input validation
  - Boolean methods for modularizing, 375–378
  - defined, 240
  - example of, 240–241
- Insert method, 450, 482, 485
- Instance of a structure, 501
  - creating, 501–502
  - creating with new operator, 501–502
  - illustrated, 501
- Instruction set, CPU, 12
- int data type, 134
- int data type, 636
  - defined, 709
- int variables
  - arrays of, 393
  - assignment compatibility, 135–136
  - defined, 134
- Integer division, 142
- Integer literal, 135
- Integer values
  - enum variable, getting, 519–520
  - enumerator, getting, 519–520
  - enumerator, specifying, 520
- Integrated development environment (IDE), 27
- IntelliSense, 91–92
- Interpreter, 17
- int.Parse method
  - defined, 367
  - statement calling, 368
  - uses, 144
  - value returned by, 368
- int.TryParse method, 233
  - example of, 234
- “Is a” relationship, 593–594, 615
  - base and derived classes, 615

- defined, 593
  - examples, 593
  - inheritance and, 593–603
  - in reverse and, 615
  - IsDigit method, 468
  - IsEven method, 375
  - IsLetter method, 468
  - IsLetterOrDigit method, 468–469
  - IsLower method, 469
  - IsPunctuation method, 469
  - IsWhiteSpace method, 470
  - Items property, 252
  - Items.Add method, 267
  - Items.Clear method, 269
  - Iteration variables, 401
- J**
- Jagged arrays. *See also* Arrays
    - code example, 445
    - defined, 445
    - illustrated, 445
    - Length property, 445
  - Java, 15
  - JavaScript, 15
- K**
- Keywords
    - abstract, 622
    - base, 611
    - C#, 16
    - const, 171
    - defined, 15
    - new, 393
    - out, 233, 363, 412, 503
    - override, 615
    - ref, 360–361, 412, 503
    - this, 183
    - virtual, 612, 615
- L**
- Label controls, 80–90
    - AutoSize property, 83–84
    - BorderStyle property, 82–83
    - clearing, 88
    - creating, 81
    - defined, 80
    - Details view and, 657, 667–668
    - displaying numeric data in, 147
    - Font property, 81–82
    - form with, 80
    - illustrated, 81
    - output in, code to display, 84–88
    - Text property, 80, 87–88, 547
    - TextAlign property, 84
  - Labels, defined, 21
  - Language Translator application
    - creation of, 88–90
    - form, 88
    - Form1 code, 89–90
    - running, 90
  - LargeChange property, 715
  - LastIndexOf method, 476, 478–481
  - Leading spaces, 482
  - Leading zeros, 153–154
  - Length property
    - arrays, 398–399
    - Box class, 610
    - defined, 398
    - jagged arrays, 446
    - Rectangle class, 610
  - Less than (<) operator, 200
  - Less than or equal to (<=) operator, 200
  - Lifetime
    - fields, 170
    - variables, 126
  - Lights application
    - creating and calling methods, 345–348
    - defined, 345
    - form, 345
    - Form1 code, 347–348
    - property settings, 345
    - repositioned controls, 346
  - Like operator, 680–681
  - Line comment, 104–105
  - List boxes
    - combo boxes *vs.*, 713, 714
    - defined, 251
    - introduction, 251–256
    - manipulating, 267–269
  - List class, 446
  - List objects
    - accessing items in, 448
    - adding items to, 447
    - adding value type objects to, 505
    - arrays *vs.*, 446
    - of class type objects, 563–564
    - Count property, 447
    - creating, 446–447
    - defined, 446
    - initializing, 447
    - inserting items into, 450
    - passing by reference, 449
    - passing to methods, 448–449
    - removing items from, 449–450
    - searching for items in, 450–451
    - storing structure objects in, 504–506
  - ListBox controls
    - adding items to, 267
    - binding columns with, 669
    - contents, manipulating, 267–269
    - DataSource property, 669
    - defined, 251
    - DisplayMember property, 669
    - illustrated, 252
    - Items property, 252
    - Items.Add method, 267
    - Items.Clear method, 269
    - Items.Count property, 268–269
    - SelectedIndex property, 253
    - SelectedItem property, 253
  - Literals
    - character, 466
  - decimal, 135
  - defined, 75
  - double, 135
  - integer, 135
  - numeric, 134–135
  - string, 75, 466
  - Load event
    - defined, 328
    - occurrence of, 329
  - Load Event application
    - defined, 329
    - displaying list of countries, 330
    - form, 329
    - Form1 code, 330–331
  - Load event handlers
    - creating, 328–329
    - example, 328
    - for setup operations, 329
    - tutorial, 329–331
  - Loan Qualifier application
    - completing, 214–217
    - form, 215
    - Form1 code, 216–217
  - Local variables, 125–126
  - Logic errors, 27
  - Logical operators, 223–227
    - ! operator, 223, 225
    - && operator, 223–224
    - || operator, 223, 224
    - Boolean expressions using, 223
    - checking numeric ranges with, 225–227
    - defined, 223
    - precedence of, 225
    - short-circuit evaluation, 224
  - long data type, 709
  - Loops
    - body, 270
    - curly braces, 270
    - do-while, 289–291
    - in *Ending Balance* application, 273–279
    - for, 281–289
    - foreach, 401–402
    - infinite, 279
    - posttest, 289
    - pretest, 272, 284–285
    - for reading end of files, 310–313
    - reading files with, 309
    - in running total calculation, 313
    - for stepping through arrays, 397–398
    - tutorials, 273–279
    - while, 269–272
  - Lottery Numbers application
    - arrays for holding list of random numbers, 399–401
    - defined, 399
    - form, 399
    - Form1 code, 400–401
  - Low-level language, 14
  - Lower() function, 679

- M**
- Machine language, 12
  - Main memory, 4
  - Math class
    - defined, 175
    - `Math.E` named constant, 177
    - `Math.PI` named constant, 177
    - methods of, 176
    - using, 175–177
  - Math expression
    - cast operators in, 141
    - defined, 138
    - example of, 138
    - grouping with parentheses, 140
    - integer division, 142
    - mixing data types in, 141
    - operands, 139, 141
    - order of operations in, 139–140
    - variables in, 139
  - Math functions (SQL), 692–693
  - Math operators
    - defined, 138
    - list of, 138
    - to perform calculations, 138–143
  - Max* application, 355–356
  - `max` function, 693
  - Maximum property, 715
  - Member declarations, 537
  - Memory
    - flash, 5
    - main, 4
    - RAM, 4
  - Menu bar (Visual Studio), 36
  - Menu designer
    - defined, 723, 724
    - illustrated, 726
    - using, 725–726
  - Menu names, defined, 724
  - Menu systems
    - checked menu items, 724, 727–728
    - Click event handler for, 729
    - commands, 724
    - creating, 723–729
    - defined, 723
    - deleting menu items from, 729
    - disabled menu items, 724, 728
    - illustrated, 723
    - inserting menu items in, 728–729
    - menu names, 724
    - rearranging menu items in, 729
    - separator bars, 724, 728
    - shortcut key, 724, 726–727
    - standard menu items, 729
    - submenus, 724, 728
  - MenuStrip control, 724–725
  - Message boxes
    - Car Truck SUV Demo* application, 603
    - code for displaying, 74
    - defined, 73
    - illustrated, 73
  - Message property, 161, 162
  - `MessageBox.Show` method, 74
  - Method body
    - defined, 341
    - statements, 342
  - Method call
    - defined, 74
    - `TryParse`, 233
  - Method headers
    - defined, 341
    - parts of, 341–342, 369
    - semicolon termination and, 342, 343
    - value-returning method, 369
    - void method, 341–342
  - Methods. *See also* specific methods
    - abstract, 621–622
    - Boolean, 374–378
    - call (*See* Method call)
    - character case conversion, 474
    - character or substring position, 476–481
    - character testing, 467–468, 467–470
    - communication between, 360
    - creating, 345–348
    - declaring inside classes, 342
    - defined, 21, 69, 339
    - in divide and conquer, 339, 340
    - execution of, 343
    - `IndexOf`, 476–478
    - introduction to, 339–341
    - `LastIndexOf`, 476, 478–481
    - Math class, 176
    - for modifying a string, 482–484
    - name of, 342
    - overloaded, 555–556
    - overriding, 613
    - parameter variables, 349
    - passing arguments by reference to, 360–367
    - passing arguments to, 349–360
    - passing arrays as arguments to, 407–413
    - passing `List` objects to, 448–449
    - passing objects to, 546
    - passing structure objects to, 502–503
    - `Remove`, 482
    - return type, 561
    - returning strings from, 378–380
    - signature, 561
    - `Substring`, 481
    - substring-searching, 475–476
    - in top-down design, 348
    - value-returning, 339, 341, 367–380
    - void, 339, 341–348
  - Microprocessors, 4
  - Microsoft Developer Network (MSDN) Library*, 42–43
  - Microsoft SQL Server Express Edition
    - data types, 636
    - defined, 634
  - `min` function, 693
  - Minimum property, 714
  - Mnemonics, 14, 180
  - Modal forms, 585
  - Modeless forms
    - defined, 585
    - execution of statements after displaying, 585
    - use of, 585
  - Modularized programs, 340
  - money data type (SQL), 636
  - Multiform Practice* application
    - creating, 581–584
    - MainForm, 581
    - MainForm form code, 584
    - MainForm form display, 583
    - MainForm.cs*, 581
    - MessageForm, 582
    - MessageForm form code, 583–584
    - MessageForm form display, 583
  - Multiform Products* application
    - Button controls, 674
    - Close* button, 675
    - creating, 672–677
    - DataGridView control, 673
    - Details view, 675
    - DetailsForm code, 675–676
    - MainForm form code, 676–677
    - table default view, changing, 674
  - Multiple-alternative decision structure
    - defined, 248
    - illustrated, 249
    - `switch` statement, 248–249
  - Multiple arguments, passing, 355–357
  - Mutually exclusive selection, 241
- N**
- Name List* application, 267–268
  - Name property
    - backing field, 613
    - controls, changing, 60–61
  - Named arguments, 357
  - Named constant
    - advantage of, 167
    - defined, 166, 167
    - `Math.E`, 177
    - `Math.PI`, 177
    - as size declarators, 394
    - using, 166–167
    - writing, 167
  - Namespace
    - defined, 69
    - .NET Framework, 69
  - Naming
    - controls, 61–62
    - projects, 40
    - solutions, 40
  - nchar data type (SQL), 636
  - Nested decision structures
    - alignment of, 217–218
    - defined, 212, 213
    - flowcharts, 212–213
    - illustrated, 214
    - indentation of, 217–218
    - testing series of conditions, 218–220

- .NET Framework
  - and C#, 22–23
  - code organization, 69
  - defined, 23, 69
  - namespaces, 69
- new keyword, 393
- new operator, 391–392, 539, 622
- New Project* window, 31
- Newline characters, 295
- Next method, 324
- NextDouble method, 324
- North America* application
  - defined, 363–364
  - displaying list of countries, 365
  - form, 363
  - Form1 code, 365–367
- Not equal to (! =) operator, 201
- NOT operator (!)
  - defined, 223, 225
  - example of, 225
  - truth table for, 225
- Nouns
  - list, refining, 569–572
  - plural *vs.* singular, 571
  - in problem domain, 568
  - simple value representation, 571
- Null values, 637
- Number List* application, 268
- Numbers
  - formatted as currency, 152
  - formatting, with ToString method, 151–158
  - getting, from TextBox, 143–146
  - storage of, 8–9
- Numeric data
  - reading from text file, 307–309
  - writing to text file, 300–301
- Numeric Data* application, 307–309
- Numeric data types, 133–134
  - defined, 133
  - invalid conversions to, 145
  - string conversions to, 144–145
  - types of, 134
- Numeric formatting
  - currency format, 152
  - examples, 153
  - exponential format, 152
  - fixed-point format, 152
  - leading zeros, 153–154
  - number format, 152
  - percent format, 152–153
  - precision specification, 153
  - rounding, 153
  - tutorial, 154–157
- Numeric literals
  - defined, 134
  - using, 134–135
- Numeric ranges, checking with logical operators, 225–227
- Numeric values
  - displaying, 146–147
  - inputting/outputting, 143–151
  - nvarchar data type (SQL), 636
- O**
- Objects
  - Button, 21
  - class type, 562–564
  - classes as blueprint for, 535–536
  - creating, 538–539
  - data storage, 21
  - defined, 21
  - file, 293–294
  - Form, 21
  - garbage collection, 403
  - generalized, 593
  - in GUI, 21
  - as instance of a structure, 501
  - as instance of class, 546
  - Label, 21
  - List, 446–451
  - passing, to method, 502–503
  - Random, 324, 392
  - reference-type, 390
  - referenced by variables, 391
  - specialized, 593
  - StreamReader, 304–306
  - StreamWriter, 294–295
  - of string data type, 475, 482, 491
  - structure, 501–506
  - TextBox, 22
  - visible *vs.* invisible, 22
- One-dimensional arrays, 436
- Open dialog box
  - default display, 320
  - defined, 318
  - displaying, 318–319
  - illustrated, 318
  - title bar display, 320
  - user selection, 319
- OpenFileDialog controls
  - in component tray, 319
  - defined, 317
  - display, 318–319
  - Filename property, 319–320
  - InitialDirectory property, 320
  - Title property, 320
- Opening files, 292
- Operands, 141
  - defined, 139
- Operating system, 6
- Operations, order of, 139–140
- Operators. *See also* specific operators
  - assignment, 85
  - cast, 136–137
  - combined assignment, 142–143
  - defined, 16
  - logical, 223–227
  - relational, 199–201
- OR operator (||)
  - defined, 223, 224
  - example of, 224
  - truth table for, 224
- or operator (SQL), 681
- Order of operations, in math expression, 139–140
- out keyword, 233, 363, 412, 503
- Output
  - devices, 5
  - Label control, code to display, 84–88
- Output files
  - defined, 292
  - specifying location of, 304
- Output folder, location of, 665
- Output parameters
  - defined, 363
  - reference parameters *vs.*, 363
  - tutorial, 363–367
  - using, 363–367
- Output symbols, flowchart, 26
- Output variable, 233
- Overloaded constructors, 561–562
- Overloaded methods, 555–556
- override keyword, 615
- Overriding
  - method, 613
  - properties, 615
- P**
- Panel control, 186
- Parallel relationship, 512
- Parameterized constructors
  - base class, 611
  - defined, 556
  - uses, 556
- Parameters
  - actual, 352
  - argument data type compatibility, 355
  - array, 410–413
  - defined, 349, 352
  - formal, 352
  - output, 363–367
  - queries, 697
  - reference, 360–362
  - scope, 355
- Parentheses
  - grouping with, 140
- Parse methods, 144, 145–146
- Partially Filled Array* application
  - Click event handler, 422–424
  - defined, 422
  - form, 422
- Partially filled arrays, 422–424
- Pascal, 15
- Pass By Ref* application
  - form, 361
  - Form1 code, 361–362
  - output, 362
- Pass By Value* application, 358–359
- Passing arguments
  - multiple, 355–357
  - to ref keyword, 361
  - by reference, 360–367

- Passing arguments (*continued*)
  - tutorial, 352–355
  - by value, 358–359
- Passing arguments by reference
  - defined, 360
  - methods, 360
  - with output parameters, 363–367
  - with reference parameters, 360–362
- Passing arrays
  - defined, 407
  - example, 408–410
  - illustrated, 408
- Passing by reference, 448–449
- Passing List objects to methods, 448–449
- Passing objects
  - to base class parameters, 616
  - to methods, 546
  - structure, 502–503
- Password Validation* application
  - completing, 471–474
  - defined, 471
  - form, 471
  - Form1 code, 472–474
- Pay and Bonus* application
  - Boolean methods for modularizing input validation, 375–378
  - defined, 375
  - form, 376
  - Form1 code, 377–378
- Payroll with Overtime* application
  - completing, 208–211
  - form, 208
  - Form1 code, 210–211
- Percent format, 152–153
- Phone Book* application
  - Add New Item* window, 639
  - column creation, 644
  - Column Properties* window, 642
  - creating, 639–647
  - data entered into table, 644
  - Data Source Configuration Wizard*, 640
  - DataGridView control placement on form, 653
  - DataGridView control selection, 652
  - Form1 code, 655
  - Identity Specification* properties, 643
  - Phonelist.mdf database, adding a table to, 641
  - Phonelist.mdf database, *Solution Explorer* entry, 640
  - Phonelist.mdf file location, 647
  - Preview Database Updates* window, 645
  - primary key designation, 637
  - running, 654
  - starting, 639–647
  - T-SQL* window, 644
  - table, entering data in, 646–647
  - Table Designer* window, 642
  - table name selection, 644
- Phonebook* application
  - completing, 509–514
  - form, 509
  - Form1 code, 512–514
  - nameListBox names, 511
  - phoneList objects, 511
  - PhoneList.txt file, 510
  - starting of, 509
- PictureBox control, 92–104
  - BorderStyle property, 95
  - Click event handler, 95
  - clickable images, 95–96
  - defined, 92
  - empty, 93
  - image displayed in, 94
  - Image property, 93
  - SizeMode property, 94–95
  - Visible property, 99–100
- PictureBox tool, 92
- Pixels (picture element), 10
- Polymorphism
  - behavior ingredients, 611–612
  - defined, 611
  - example, 612
  - flexibility in designing applications, 616
  - tutorial, 616–621
- Polymorphism* application
  - Animal.cs* file code, 618–619
  - Cat.cs* file code, 619–620
  - completing, 616–621
  - Dog.cs* file code, 619
  - form, 616
  - Form1 code, 620–621
- Postfix mode, 280
- Posttest loops
  - defined, 289
  - do-while loops as, 289, 290
- Precedence, of logical operators, 225
- Prefix mode, 280
- Presidential Trivia* application
  - control property settings, 86
  - form illustration, 86
  - running, 87
- Pretest loops
  - defined, 272
  - for loops as, 284–285
  - while loops as, 272
- Primary keys
  - assigning values, 637
  - defined, 636
  - examples, 636
- Primitive data types, 122, 709
- private access modifier, 168, 341, 538
- Problem domain
  - car class, 574
  - customer class, 573–574
  - defined, 568
  - description, 568
  - description review, 570
  - nouns in, 568
  - ServiceQuote class, 575–576
- Processing files, 292
- Processing symbols, flowchart, 26
- Product Lookup* application, 669–671
- Product Queries* application
  - adding queries to table adapter, 685–686
  - Button controls added to form, 691
  - command type selection, 686
  - creating, 684–692
  - defined, 684
  - form, 685
  - Form1 code, 691–692
  - function name specification, 694
  - methods to generate selection, 688, 690
  - query type selection, 686–687
  - SQL select statement specification, 687
  - TableAdapter Query Configuration Wizard*, 688–690
- Product Search* application
  - creating, 697–702
  - defined, 697
  - form, 698
  - Form1 code, 701–702
  - methods to generate selection, 700
  - SQL select statement specification, 699
  - TableAdapter Query Configuration Wizard*, 699–700
- Products* application
  - Add Connection* dialog box (Visual Studio), 659
  - creating, 657–664
  - data connection selection, 658
  - Data Source Configuration Wizard*, 657–658
  - data source type selection, 657
  - Data Sources* window, 662–663
  - database model selection, 658
  - database objects selection, 662
  - Details view control, 663–664
  - dragging Products table onto form, 663
  - multiform, creation of, 672–675
  - placing Details view controls, 664
  - product table, 663
  - ProductDB.mdf database, 660
  - running, 664
  - saving connection string, 661
- Program development cycle
  - code writing, 26
  - defined, 23
  - GUI design, 24–25
  - illustrated, 24
  - logic design, 25–26
  - logic error correction, 27
  - program purpose understanding, 24
  - program testing, 27
  - syntax error correction, 27
- Program.cs file, 67
- Programmers, 1
- Programming languages
  - assembly language, 13–14
  - list of, 15

- low-level, 14
- machine language, 12
- object oriented, 21
- Programs. *See also* Software
  - compiling, 17
  - control, transfer of, 344
  - defined, 1
  - development process, 23–27
  - event-driven GUI, 20
  - execution with interpreter, 17
  - Hello World*, 62–66
  - logic, designing, 25–26
  - modularized, 340
  - purpose of, 24
  - testing, 27
  - using files for data storage, 291
  - utility, 6
  - working of, 11–18
- Project folder, 40
- PROJECT menu, 540, 578
- Projects
  - adding code to, 71–73
  - adding forms to, 578–579
  - closing, 33
  - defined, 31, 39
  - existing, opening, 41
  - naming, 40
  - organization on disk, 40
  - output folder, 665
  - renaming, 32
  - saving, 33
  - and solutions, 39
  - starting, 31–33
- Properties
  - abstract, 622
  - AcceptButton, 181
  - as an argument, 550
  - assigning to variables, 547
  - AutoPopDelay, 712
  - AutoSize, 83–84
  - BackColor, 182, 183
  - BackgroundImage, 183
  - BackgroundImageLayout, 183–184
  - backing field, 547
  - Boolean, 99, 100
  - CancelButton, 181
  - Checked, 242–243, 244, 727–728
  - CheckOnClick, 727
  - DataSource, 669
  - defined, 21, 547
  - DisplayMember, 669
  - EndOfStream, 309
  - exception object, 161
  - Filename, 319–318, 321–320
  - Font, 81–82
  - ForeColor, 182
  - Height, 610
  - Images, 93, 522
  - ImageSize, 522
  - InitialDelay, 712
  - InitialDirectory, 320, 322
  - Items, 252
  - LargeChange, 715
  - Length, 610
  - list of, 55
  - Maximum, 715
  - Message, 161, 162
  - Minimum, 714
  - Name, 60–61
  - overriding, 615
  - passing as arguments, 550
  - public fields *vs.* 549–550
  - Radius, 555
  - read-only, 554–555
  - ReshowDelay, 712
  - SelectedIndex, 253
  - SelectedItem, 253
  - SelectionLength, 721
  - SelectionStart, 721
  - set accessor for, 554
  - ShortcutKeys, 727
  - Size, 57
  - SizeMode, 94–95
  - SmallChange, 715
  - TabIndex, 178–179
  - Text, 547, 551–552, 558 (*See* Text property)
  - TextAlign, 84
  - Title, 320, 322
  - ToolTip controls, 712
  - Value, 714
  - Visible, 99–100
  - Weight, 615
  - Width, 610
- Properties window, 33, 34, 55–57
  - Alphabetical button, 57
  - Categorized button, 57
  - drop-down list of colors, 182
  - floating, 39
  - hiding, 35
  - illustrated, 56
- Pseudocode, 25–26
- Pseudorandom numbers, 328
- public access modifier, 341
- Public fields, 549–550
- Python, 15
- Q**
  - Queries
    - defined, 678
    - parameters, 697
    - select, results, 681
    - table adapters, 682–692, 684–692
- R**
  - Radio buttons, 241–244
    - creation of, 242–244
    - defined, 241, 242
    - illustrated, 241
    - mutually exclusive selection, 241
    - working with code, 243–244
  - RadioButton application, 243–244
  - RadioButton controls
    - Checked property, 242–243
    - defined, 242
    - illustrated, 242
    - Text property, 242
  - RAM (random-access memory), 4
  - Random-access memory (RAM), 4
  - Random Card application
    - completing, 524–526
    - defined, 524
    - form, 524
    - Form1 code, 525–526
  - Random class
    - creating objects from, 391–392
    - defined, 323
  - Random numbers
    - defined, 323
    - seeds, 328
    - uses, 323
  - Random objects, 323
    - Next method, 324
    - NextDouble method, 324
    - rand variable referencing, 324, 328, 392
    - seed value, 328
  - Range Checker application, 226–227
  - Read-only properties, 554–555
  - Read position, 306–307
  - Reading data
    - numeric, from text file, 307–309
    - read position, 306–307
    - with StreamReader object, 304–306
  - Reading files, with loops, 309
  - ReadLine method
    - call, 306, 307
    - defined, 304
    - read position, 306
  - Rectangle class, 609–611
  - ref keyword
    - with array parameter, 412
    - defined, 360
    - in parameter declaration, 503
    - passing arguments to, 361
    - use of, 360–361
  - Reference copies, 416
  - Reference parameters
    - for communication between methods, 360
    - defined, 360
    - output parameters *vs.*, 363
    - passing arguments by reference with, 360–362
  - Reference types. *See also* Data types
    - arrays as, 393
    - defined, 389
    - working with, 390
  - Reference variables
    - = = operator with, 417
    - declaring, 391
    - defined, 391
    - reassigning, 402–403

- Relational operators
    - ! = operator, 201
    - = = operator, 199, 200–201, 229
    - Boolean expressions and, 199–201
    - defined, 199
    - < = operator, 200
    - > = operator, 200
    - list of, 200
    - SQL (structured query language), 679
    - and string comparisons, 229–232
  - Remove method, 482
    - defined, 449
    - return values, 449–450
    - sequential search, 450
    - in string modification, 482
  - RemoveAt method, 449
  - Reserved words. *See* Keywords
  - ReshowDelay property, 712
  - Return point, 344
  - Return type, in method header, 341
  - Rounding, 153
  - Rows
    - defined, 635
    - two-dimensional arrays, summing, 443–444
  - Ruby, 15
  - Run time, 76–77
  - Running total calculation
    - defined, 313
    - elements, 313
    - logic, 313
    - tutorial, 314–316
- S**
- Sales Price Calculator* application
    - control property settings, 155
    - creating, 154–157
    - form, 154
    - Form1 code, 156–157
    - illustrated, 156
  - Samples, 11
  - Save As dialog box
    - buttons, 321
    - default display, 322
    - defined, 320
    - displaying, 320–321
    - illustrated, 321
    - title bar display, 322
    - user specification, 321
  - Save Project window, 40
  - SaveFileDialog controls
    - adding, 320
    - defined, 317, 320
    - displaying, 320–321
    - Filename property, 321–322
    - InitialDirectory property, 322
    - ShowDialog method, 320–321
    - Title property, 322
  - SavingsAccount class, 604–605
  - sbyte data type, 709
  - Schema definition files, 682, 687
  - Scope, variables
    - defined, 126
    - parameter, 355
  - Scroll bars
    - defined, 714
    - horizontal, 714
    - vertical, 714
  - Search algorithms, 414
  - Search criteria, with where clause, 678–680, 692
  - Seating Chart application
    - completing, 439–443
    - defined, 439–440
    - form, 440
    - Form1 code, 441–443
    - seat prices table, 440
  - Secondary storage, 4–5
  - Secret Word application, 229–230
  - Seed value, 327
  - Seeds, random number, 328
  - Select query, 681
  - Select statement, 678–680, 682, 684, 687, 689, 692, 694–695, 699
    - defined, 678
    - general format, 678
    - Like operator, 680–681
    - math functions, 692–693
    - And operator, 681
    - or operator, 681
    - query results, sorting, 681
    - table name, 684
    - where clause, 678–680, 692
  - Selected Text Demo application, 722–723
  - SelectedIndex property
    - ListBox control, 253
  - SelectedItem property
    - ListBox control, 253
  - Selection sort algorithm. *See also* Arrays
    - defined, 429
    - functioning of, 429–430
    - swapping array elements, 431–434
    - values after swaps, 429–430
  - Selection Sort application
    - defined, 432
    - form, 432
    - Form1 code, 432–434
  - SelectionLength property, 721
  - SelectionStart property, 721
  - Semicolon (;), 74
  - Separator bar
    - defined, 724
    - inserting, 728
  - Sequence structures
    - combining with decision structure, 212
    - defined, 197
  - Sequential access files, 293
  - Sequential execution, statements, 103–104
  - Sequential search algorithms
    - defined, 414
    - IndexOf method, 451
    - Remove method, 450
  - SequentialSearch method, 414–415
  - Server Explorer, 640–641, 644–645
  - ServiceQuote class, 572, 575–576
  - Short-circuit evaluation, 224
  - short data type, 709
  - Shortcut keys, 726–727
    - defined, 724
  - ShortcutKeys property, 727
  - Show method, 585
  - ShowDialog method, 319, 320–321
  - Signature of method, 561
  - Simple combo boxes, 712, 713
  - Simple Method application, 343–344
  - Single-alternative decision structure, 198–199. *See also* If statement
  - Size declarators
    - defined, 393
    - initialization list and, 397
    - named constants as, 394
    - two-dimensional arrays, 437
  - Size property, 57
  - SizeMode property
    - defined, 94
    - values, 94–95
  - Sizing handles, 54
  - SmallChange property, 715
  - Smart tags, 665
  - Software
    - application, 6
    - defined, 1, 2
    - developers (*See* Programmers)
    - system, 6
  - Software development tools, 6
  - Solution Explorer window, 33, 34
    - floating, 39
    - forms, 581
    - hiding, 35
    - for opening forms in Designer window, 42
    - source code files in, 67
  - Solution file, 40
  - Solution folder, 40
  - Solutions
    - defined, 39
    - naming, 40
    - organization on disk, 40
  - Source code
    - adding to projects, 71–73
    - braces, 69–70
    - CheckBox control, 244–245
    - for closing application's form, 106–107
    - debugging, 27
    - defined, 17
    - to display output in Label control, 84–88
    - event handler, 71–73
    - files, 67
    - form, 580
    - Form1.cs, 68, 69
    - .NET Framework, 69

- radio buttons in, 243–244
- setting colors in, 182–183
- writing, for *Hello World* program, 77–80
- writing, in development cycle, 26
- South America* application
  - Countries.txt, 310
  - defined, 310
  - displaying list of countries, 311
  - form, 310
  - Form1 code, 312–313
- Spaces, 482
- Specialization, 593
- Speed Converter* application
  - defined, 286–287
  - form, 287
  - Form1 code, 288–289
- SportUtility* class, 595, 600–601, 603
- Spreadsheets, 291
- SQL (structured query language)
  - defined, 677
  - keywords, 678
  - math functions, 692–693
  - queries, 678
  - relational operators, 679
  - select statement, 678–680, 682, 684, 687, 689, 692, 694–695, 699
  - string comparisons, 679
  - table adapter queries, 682–692
- Squares* application, 283–284
- Stale data, 555
- Standard toolbar (Visual Studio)
  - buttons, 36
  - defined, 36
- Start terminal symbol, flowchart, 26
- startswith method, 475
- Statements
  - assignment, 85
  - defined, 16
  - if, 197–206
  - if-else, 206–211
  - if-else-if, 220–222
  - multiple variable declaration, 132
  - select (SQL), 678–680, 682, 684, 687, 689, 692, 694–695, 699
  - sequential execution of, 103–104
  - switch, 248–251
  - this.Close();, 106–107
  - try-catch, 159
  - variable declaration, 122, 125
- Stepwise refinement, 348
- Storage. *See* Data storage
- StreamReader class
  - defined, 294
  - ReadLine method, 304, 306, 307
- StreamReader object
  - EndOfStream property, 309
  - inputFile reference, 309
  - reading data from files with, 304–306
- Streams, opening, 294
- StreamWriter class
  - defined, 294
  - StreamWriter object, 294–295
  - writeLine method, 294–296
- String Collection Editor* dialog box, 252
- String comparisons, 229–232
  - = = operator for, 229
  - character-by-character, 230–231
  - defined, 228, 229
  - greater than/less than, 230
  - by string.Compare method, 230–231
- string data type, 466, 475, 482, 491, 709
- String literal
  - defined, 75
  - storage in string variable, 127
- string object, 482
- string variables
  - demo application, 124
  - string literal storage in, 127
  - using, 123
- string.Compare method, 230, 231–232
- Strings, 74
  - comparisons (*See* String comparisons)
  - concatenation, 123–125
  - conversions, to numeric data types, 144–145
  - empty, 120
  - formatting, 151, 152
  - implicit conversion with + operator, 147
  - invalid conversions, 145–146
  - .NET Framework and, 465
  - retrieving characters in, 466
  - returning from methods, 378–380
  - subscripts, 467
  - Text property and, 87–88
  - tokenizing, 491–494
- stringVar.EndsWith, 476
- stringVar.IndexOf, 476–478
- stringVar.Insert, 482
- stringVar.LastIndexOf, 478–481
- stringVar.Remove, 482
- stringVar.StartsWith, 475
- stringVar.Substring, 481
- stringVar.ToLower, 483
- stringVar.ToUpper, 483
- stringVar.Trim, 483
- stringVar.TrimEnd, 483
- stringVar.TrimStart, 483
- Structure instances, 501, 505
  - creating, 501–502
  - creating with new operator, 501–502
  - illustrated, 501
- Structure objects
  - arrays of, 504
  - assigning one to another, 502
  - comparing, 504
  - passing to methods, 502–503
  - storing in Lists, 504–507
- Structures
  - C#, 499–500
  - declaration, 499–500
  - declarations, location of, 500
  - defined, 499
  - fields, 499
  - fields, accessing, 502
  - names, 499–500
  - parallel relationships, 512
  - uses for, 499
  - as value types, 501
- Student Names* project
  - code, 304–305
  - detail, 305–306
- Submenus
  - creating, 728
  - defined, 724
- Subscripts
  - defined, 394
  - illustrated, 394
  - invalid, 398, 467
  - read-only access, 467
  - string, 467
  - two-dimensional arrays, 438
  - valid, 398
- Substring method, 481
- Substring methods
  - defined, 481
  - stringVar.Contains, 475
  - stringVar.EndsWith, 476
  - stringVar.IndexOf, 476–478
  - stringVar.Insert, 482
  - stringVar.LastIndexOf, 478–481
  - stringVar.Remove, 482
  - stringVar.StartsWith, 475
  - stringVar.Substring, 481
  - stringVar.ToLower, 483
  - stringVar.ToUpper, 483
  - stringVar.Trim, 483
  - stringVar.TrimEnd, 483
  - stringVar.TrimStart, 483
- Substrings
  - defined, 475
  - position methods, 476–481
- Sum* application
  - arguments passed to, 371
  - defined, 369
  - form, 369
  - Form1 code, 370–371
  - value returned, 371
- sum function, 692
- Summing
  - two-dimensional array columns, 444
  - two-dimensional array elements, 443
  - two-dimensional array rows, 443–444
- Superclasses. *See* Base classes
- Swapping array elements, 431–434
- switch statement
  - as alternative to if-else-if statement, 250–251
  - defined, 248



switch statement (*continued*)  
 example code, 250  
 execution, 250  
 format of, 249  
 as multiple-alternative decision structure, 248–249

Syntax  
 defined, 16  
 rules, 18

Syntax error  
 correcting, 27  
 dealing with, 107–108  
 debugging, 108  
 defined, 17, 107  
 underlined, 108

System software, 6

## T

Tab order  
 changing, 178–179  
 defined, 178  
 forms, 177–179

GroupBox control, 185  
 selection mode, 178

TabControl controls, 716

*TabControl Demo* application, 717

TabIndex property  
 defined, 178  
 GroupBox control, 185  
 values, 178–179

Table adapter  
 adding query to, 684  
 defined, 638

Fill method, 682

Table adapter queries  
 adding, 684–691  
 defined, 682  
 editing, 687  
 tutorial, 684–691

*TableAdapter Configuration Wizard*, 682–683  
 command type selection, 686  
 displaying, 682–683  
 function name specification, 694  
 illustrated, 682–683  
 methods to generate selection, 688, 690, 700  
 query type selection, 686  
 results, 688  
 SQL `select` statement specification, 687, 689, 694, 699

*Table Designer* window  
 columns created in, 641  
 illustrated, 642

Tables. *See also* Columns; Rows  
 data, showing, 646–647  
 dragging from *Data Sources* window, 652  
 entering data into, 646  
 naming, 644

primary keys, 636

TabPage controls, 716–717

*Telephone Format* application  
 completing, 484–487  
 defined, 484  
 form, 484  
 Form1 code, 486–487

*Telephone Unformat* application  
 completing, 488–491  
 defined, 488  
 form, 488  
 Form1 code, 489–491

Terminal symbols, 26

*Test Average* application  
 array processing, 424–428  
 control property settings, 163  
 creating, 162–166  
 defined, 422  
 form, 162, 424  
 Form1 code, 165–166, 426–428  
 illustrated, 164, 426

*Test Score Average* application  
 average and message displayed, 204  
 average displayed, 202  
 completing, 202–206  
 form, 202  
 Form1 code, 204–206

*Test Score List* application  
 completing, 452–456  
 defined, 452  
 form, 452  
 Form1 code, 454–456  
 illustrated, 454

Testing classes, 603–604

Testing programs, in development  
 cycle, 27

Text, alignments, 84

Text files  
 defined, 293  
 reading numeric data from, 307–309  
 writing data to, 297–300  
 writing numeric data to, 300–301

Text property  
 access key assignment with, 180–181  
 Button control, changing, 59–60, 65  
 CheckBox control, 244  
 GroupBox control, 184  
 Label control, 80, 87–88, 547  
 RadioButton controls, 242  
 and strings, 87–88  
 TextBox control, 119, 120

TextAlign property, 84  
 setting, 85

TextBox control  
 contents of, clearing, 120–121  
 defined, 119  
 getting numbers from, 143–146  
 illustrated, 120  
 multiple, validating data in, 235–237  
 reading input with, 119–121

SelectionLength property, 721  
 SelectionStart property, 721  
 Text property, 119, 120  
 validating, 236

TextBox objects  
 defined, 22

TextBox tool, 119

this keyword, 183

`this.Close()`; statement, 106–107

*Time Zone* application  
 control property settings, 254  
 creating, 253–256  
 form, 254  
 Form1 code, 255–256

Title property  
 OpenFileDialog control, 320  
 SaveFileDialog control, 322

Tokenizing strings  
 defined, 491  
 with `split` method, 491–492  
 trimming before, 493–494

Tokens, 491–492

`ToLower` method, 474, 482

*Toolbox*  
 CheckBox control, 244  
 controls, 57–58  
 defined, 36  
 displaying, 37  
 ErrorProvider component, 719  
 floating, 39  
 GroupBox control, 184  
 illustrated, 37, 58  
 ImageList control, 522

Label control, 80  
 ListBox control, 252  
 OpenFileDialog control, 318  
 PictureBox tool, 92  
 RadioButton control, 242  
 SaveFileDialog control, 320–321  
 sections, 37–38  
 TextBox tool, 119  
 WebBrowser control, 718

ToolStripMenuItem object, 729

ToolTip, 711

ToolTip controls  
 defined, 711  
 illustrated, 712  
 properties, 712

ToolTips, 38

Top-down design, 348

`Toss` method, 538–539, 546

`ToString` method  
 for converting char variable to  
 string, 466  
 defined, 146

enumerator, 517  
 formatting numbers with, 151–158  
 SelectedItem property, 253

*Total Sales* application  
 defined, 314

- displaying total sales, 315
  - form, 314
  - Form1 code, 315–316
  - ToUpper method, 474, 482
  - Trailing spaces, 482
  - Trim method, 482, 494
  - TrimEnd method, 482
  - Trimming, strings, 493–494
  - Truck class, 595, 600–602
  - Truncation, 137
  - Try block, 158
  - Try-catch statement, 159, 233
  - TryParse methods
    - calling, 233
    - defined, 233
    - format of, 233
    - preventing data conversion exceptions with, 232–239
    - types of, 233
  - Two-dimensional arrays. *See also* Arrays
    - columns, summing, 444
    - declaring, 437–438
    - defined, 436
    - elements, accessing, 438–439
    - illustrated, 436–437
    - implicit sizing of, 439
    - initialization of, 439
    - rows, summing, 443–444
    - size declarators, 437
    - subscripts, 438
    - summing elements of, 443
    - tutorial, 439–443
    - uses, 437
  - Two's complement, 10
- U**
- uint data type, 709
  - ulong data type, 709
  - Universal serial bus (USB) drives, 5
  - Update expression
    - declaring counter variable in, 285
    - defined, 282
  - USB (universal serial bus) drives, 5
  - User interface
    - defined, 18
    - graphical (*See* Graphical user interfaces (GUIs))
  - Users
    - defined, 18
    - file location specification, 304
  - ushort data type, 709
  - using System.IO; directive, 294, 310, 329, 364
  - Utility program, 6
- V**
- Validation, input, 240–241
  - Value, passing arguments by, 358–359
  - Value property, 714
  - Value-returning methods. *See also* Methods
    - calling, 341
    - defined, 339, 367
    - example, 367–368, 369
    - general format, 368
    - method header, 369
    - void method similarities, 367
    - writing, 368–374
    - writing tutorial, 372–374
  - Value types. *See also* Data types
    - declaring, 389–390
    - defined, 390
  - Values
    - array, averaging, 418–419
    - array, highest and lowest, 419–421
    - array, totaling, 418
    - of binary digits, 8
    - constant field, 171
    - explicitly converting, with cast operators, 136–137
    - math expressions, 140
    - null, 637
    - numeric, 143–151
    - SizeMode property, 94–95
    - Visible property, 99
  - Variable declaration
    - defined, 122
    - multiple, 132
    - statement, 122, 125
  - Variable name, 122–123
    - defined, 122
    - duplicate, 126
  - Variables
    - assignment compatibility, 126–127
    - bool, 228
    - cast operators applied to, 137
    - counter, 272, 285–286
    - data type (*See* Data types)
    - decimal, 134
    - declaring as fields, 167–175
    - decrementing, 280–281
    - defined, 121, 122
    - double, 134
    - flag, 228
    - holding one value at a time, 127–128
    - incrementing, 280–281
    - initializing, 132
    - int, 134, 135–136
    - iteration, 401
    - lifetime of, 126
    - local, 125–126
    - in math expression, 139
    - naming, 122–123
    - output, 233
    - parameter, 349
    - passing as arguments, 351
    - reference, 391
    - referencing objects, 293–294
    - scope, 126
    - string, 123, 127
    - ToString method, 146
    - value-type, 389–390
    - values assigned to, 390
  - virtual keyword, 612, 615
  - Visible property
    - defined, 99
    - values, 99
  - Visual Basic, 15
  - Visual Studio, 24–25
    - Auto Hide, 34–35
    - break mode, 158
    - code editor, 67, 70–71, 91–92
    - as customizable environment, 28
    - defined, 27
    - documentation, 42–43
    - environment setup, 28–31
    - menu bar, 36
    - menu designer, 723, 725–726
    - standard toolbar, 36
    - Start Page, 28, 29
    - Toolbox, 36–38
    - ToolTips, 38, 711
    - window layout, resetting, 29, 31
  - Visual Studio 2012 Express for Windows Desktop, 28
  - Visual Studio environment, 33–34, 64
    - Designer window, 33–34
    - open project in, 33
    - Properties window, 33, 34
    - Solution Explorer window, 33, 34
    - tutorial, 43
  - void methods. *See also* Methods
    - calling, 341
    - defined, 339, 341
    - method header, 341–342
  - Volatile, memory type, 4
  - VScrollBar control, 715
- W**
- Web browsers, 291
  - WebBrowser control, 718
  - WebBrowser Demo application, 718–719
  - Weight property, 615
  - where clause, 678–680, 692
  - While Loop Demo project, 270–271, 272
  - while loops. *See also* Loops
    - body, 270
    - curly braces, 270
    - defined, 269
    - execution, 270
    - flowchart, 272
    - general format, 270
    - illustrated, 271
    - infinite, 279
    - logic, 269
    - non-iteration characteristic, 272

- while loops. *See also* Loops (*continued*)
  - parts, 269
  - as pretest loops, 272
  - while clause, 270
- White-space characters, 470, 492, 494
- Width property, 611
- Windows. *See also* specific Windows
  - docked, 38
  - floating, 38–39
- Word processors, 291
- write method
  - defined, 296
  - items written with, 296
  - writing data with, 295–296
  - in writing numeric data, 300
- writeLine method
  - defined, 294
  - items written with, 296
- in writing numeric data, 300
- Writing data
  - numeric, to text file, 300–301
  - with StreamWriter object, 294–295
  - to text file, 297–300
  - with write method, 295–296

**Z**

Zeros, leading, 153–154